

Fluke 192B/196B-C/199B-C
ScopeMeter

Service Manual

PN 4822 872 05391



September 2002

© 2002 Fluke Corporation, All rights reserved. Printed in the Netherlands
All product names are trademarks of their respective companies.



Table of Contents

Chapter	Title	Page
1	Safety Instructions	1-1
	1.1 Introduction.....	1-3
	1.2 Safety Precautions.....	1-3
	1.3 Caution and Warning Statements.....	1-3
	1.4 Symbols.....	1-3
	1.5 Impaired Safety.....	1-4
	1.6 General Safety Information.....	1-4
2	Characteristics	2-1
	2.1 Introduction.....	2-3
	2.2 Dual Input Oscilloscope.....	2-3
	2.2.1 Isolated Inputs A and B (Vertical).....	2-3
	2.2.2 Horizontal.....	2-4
	2.2.3 Trigger and Delay.....	2-4
	2.2.4 Automatic Connect&View Trigger.....	2-5
	2.2.5 Edge Trigger.....	2-5
	2.2.6 Isolated External Trigger.....	2-5
	2.2.7 Video Trigger.....	2-5
	2.2.8 Pulse Width Trigger.....	2-5
	2.2.9 Continuous Auto Set.....	2-6
	2.2.10 Automatic Capturing Scope Screens.....	2-6
	2.3 Automatic Scope Measurements.....	2-6
	2.3.1 General.....	2-6
	2.3.2 DC Voltage (VDC).....	2-6
	2.3.3 AC Voltage (VAC).....	2-6
	2.3.4 AC+DC Voltage (True RMS).....	2-7
	2.3.5 Amperes (AMP).....	2-7
	2.3.6 Peak.....	2-8
	2.3.7 Frequency (Hz).....	2-8
	2.3.8 Duty Cycle (DUTY).....	2-8
	2.3.9 Pulse Width (PULSE).....	2-8
	2.3.10 Vpwm (C versions only).....	2-8
	2.3.11 Power.....	2-9
	2.3.12 Phase.....	2-9
	2.3.13 Temperature (TEMP).....	2-9
	2.3.14 Decibel (dB).....	2-9
	2.4 Meter.....	2-10
	2.4.1 Meter Input.....	2-10
	2.4.2 Meter Functions.....	2-10
	2.5 DMM Measurements on Meter Inputs.....	2-10
	2.5.1 General.....	2-10

2.5.2 Ohms (Ω).....	2-10
2.5.3 Continuity (CONT).....	2-10
2.5.4 Diode.....	2-11
2.5.5 Temperature (TEMP).....	2-11
2.5.6 DC Voltage (VDC).....	2-11
2.5.7 AC Voltage (VAC).....	2-11
2.5.8 AC+DC Voltage (True RMS).....	2-11
2.5.9 Amperes (AMP).....	2-12
2.6 Recorder.....	2-12
2.6.1 TrendPlot (Meter or Scope).....	2-12
2.6.2 Scope Record.....	2-12
2.7 Zoom, Replay and Cursors.....	2-13
2.7.1 Zoom.....	2-13
2.7.2 Replay.....	2-13
2.7.3 Cursor Measurements.....	2-13
2.8 Miscellaneous.....	2-13
2.8.1 Display.....	2-13
2.8.2  Power.....	2-13
2.8.3 Probe Calibration.....	2-14
2.8.4 Memory.....	2-14
2.8.5 Mechanical.....	2-14
2.8.6 Optical Interface Port.....	2-14
2.9 Environmental.....	2-14
2.10  Safety.....	2-15
2.11 10:1 probe VPS200.....	2-17
2.11.1 Safety.....	2-17
2.11.2 Electrical specifications.....	2-17
2.11.3 Environmental.....	2-17
2.12 Electromagnetic Immunity.....	2-18
3 Circuit Description.....	3-1
3.1 Introduction.....	3-3
3.2 Block Diagram.....	3-3
3.3 Start-up Sequence, Operating Modes.....	3-7
3.4 Detailed Circuit Descriptions.....	3-9
3.4.1 Scope Channel A - Scope Channel B.....	3-9
3.4.2 Meter/Ext Trigger Channel.....	3-12
3.4.3 Sampling&Triggering (S-ASIC).....	3-15
3.4.4 S-ASIC supply.....	3-19
3.4.5 ADC's.....	3-19
3.4.6 Digital Control.....	3-20
3.4.7 LCD Control.....	3-22
3.4.8 Power.....	3-23
3.4.9 Slow ADC, RS232 Serial Interface, LCD Backlight.....	3-28
4 Performance Verification.....	4-1
4.1 Introduction.....	4-3
4.2 Equipment Required For Verification.....	4-3
4.3 General Instructions.....	4-3
4.4 Operating Instructions.....	4-4
4.4.1 Resetting the test tool.....	4-4
4.4.2 Navigating through menu's.....	4-4
4.4.3 Creating Test Tool Setup1.....	4-5
4.5 Display and Backlight Test.....	4-5

4.6 Scope Input A&B Tests	4-7
4.6.1 Input A&B Vertical Accuracy Test	4-7
4.6.2 Input A&B DC Voltage Accuracy Test.....	4-9
4.6.3 Input A&B AC Voltage Accuracy Test (LF).....	4-11
4.6.4 Input A & B AC Coupled Lower Frequency Test.....	4-12
4.6.5 Input A and B Peak Measurements Test.....	4-13
4.6.6 Input A&B Frequency Measurement Accuracy Test	4-14
4.6.7 Input A&B Phase Measurements Test.....	4-15
4.6.8 Time Base Test	4-16
4.6.9 Input A Trigger Sensitivity Test	4-18
4.6.10 Input A AC Voltage Accuracy (HF) & Bandwidth Test	4-19
4.6.11 Input B Trigger Sensitivity Test	4-20
4.6.12 Input B AC Voltage Accuracy (HF) & Bandwidth Test	4-21
4.6.13 Video test using the Video Pattern Generator	4-22
4.6.14 Video test using SC600 Scope Calibration Option	4-25
4.7 External Trigger Level Test	4-27
4.8 Meter (DMM) Tests	4-28
4.8.1 Meter DC Voltage Accuracy Test	4-28
4.8.2 Meter AC Voltage Accuracy & Frequency Response Test.....	4-29
4.8.3 Continuity Function Test	4-30
4.8.4 Diode Test Function Test	4-30
4.8.5 Ohms Measurements Test.....	4-30
4.9 Probe Calibration Generator Test	4-32
5 Calibration Adjustment	5-1
5.1 General	5-3
5.1.1 Introduction.....	5-3
5.1.2 Calibration number and date.....	5-3
5.1.3 General Instructions.....	5-3
5.1.4 Equipment Required For Calibration	5-4
5.2 Calibration Procedure Steps.....	5-4
5.3 Starting the Calibration	5-4
5.4 Contrast Calibration Adjustment	5-6
5.5 Warming Up & Pre-Calibration	5-7
5.6 Final Calibration	5-8
5.6.1 Input A LF-HF Gain	5-8
5.6.2 Input B LF-HF Gain.....	5-9
5.6.3 Input A&B LF-HF Gain.....	5-11
5.6.4 Input A&B Position	5-12
5.6.5 Input A&B Volt Gain	5-13
5.6.6 DMM Volt Gain	5-14
5.6.7 Input A& B, and DMM Zero	5-15
5.6.8 DMM Ohm Gain.....	5-16
5.6.9 Calculate Gain.....	5-17
5.7 Save Calibration Data and Exit	5-17
5.8 Probe Calibration	5-19
6 Disassembling the Test Tool	6-1
6.1. Introduction.....	6-3
6.2. Disassembly & Reassembly Procedures	6-3
6.2.1 Required Tools	6-3
6.2.2 Removing the Tilt Stand & Hang Strap.....	6-3
6.2.3 Replacing the Side-Strap, Changing the Side-Strap Position.....	6-3
6.2.4 Opening the Test Tool, Removing the Battery.....	6-3

6.2.5	Removing the Main PCA Unit and the Fan.....	6-5
6.2.6	Removing the Display Assembly.....	6-6
6.2.7	Replacing the LCD Window/Decal.....	6-7
6.2.8	Removing the Keypad and Keypad Foil.....	6-7
6.2.9	Disassembling the Main PCA Unit.....	6-7
6.2.10	Reassembling the Main PCA Unit.....	6-8
6.2.11	Reassembling the Test Tool.....	6-9
7	Corrective Maintenance.....	7-1
7.1	Introduction.....	7-3
7.2	Starting Fault Finding.....	7-4
7.3	Charger Circuit.....	7-5
7.4	Starting with a Dead Test Tool.....	7-7
7.4.1	Test Tool Completely Dead.....	7-7
7.4.2	Test Tool Software Does not Run.....	7-8
7.4.3	Software Runs, Test Tool not Operative.....	7-8
7.5	Miscellaneous Functions.....	7-8
7.5.1	Display and Back Light.....	7-8
7.5.2	Fly Back Converter.....	7-10
7.5.3	Slow ADC, +3V3SADC.....	7-11
7.5.4	Keyboard.....	7-12
7.5.5	Optical Port (Serial RS232 Interface).....	7-13
7.5.6	Channel A, Channel B Measurements.....	7-13
7.5.7	Meter Channel (Ext Trigger, Probe Cal).....	7-15
7.5.8	Input Signal Acquisition.....	7-17
7.5.9	ADC's.....	7-19
7.5.10	Digital Control & Memory.....	7-20
7.5.11	Buzzer Circuit.....	7-20
7.5.12	RAM Test.....	7-21
7.5.13	Power ON/OFF.....	7-22
7.5.14	Battery.....	7-22
7.6	Loading Software.....	7-23
8	List of Replaceable Parts.....	8-1
8.1	Introduction.....	8-3
8.2	How to Obtain Parts.....	8-3
8.3	Service Centers.....	8-3
8.4	Final Assembly Parts.....	8-4
8.5	Main PCA Unit Parts.....	8-6
8.6	Main PCA Parts.....	8-8
8.7	Accessories.....	8-30
9	Circuit Diagrams.....	9-1
9.1	Introduction.....	9-3
9.2	Tracing signals in circuit diagrams.....	9-3
9.3	Locating Parts & Test Points.....	9-3
9.4	Diagrams.....	9-6
10	Modifications.....	10-1
10.1	General.....	10-3
10.2	Software modifications.....	10-3
10.3	Hardware modifications.....	10-3
10.4	Main PCA Unit Versions, Software Versions.....	10-4

List of Tables

Table	Title	Page
2-1.	Scope No Visible Disturbance at E=3 V/m.....	2-18
2-2.	Scope Disturbance <10% at E=3 V/m.....	2-18
2-3.	Meter Disturbance <1% at 3 V/m	2-18
3-1.	Fluke190B-C Main Functional Blocks.....	3-3
3-2.	Fluke190B-C Operating Modes	3-8
3-3.	D-ASIC PWM Signals.....	3-22
4-1.	Vertical Accuracy Verification Points	4-8
4-2.	Volts DC Measurement Verification Points	4-10
4-4.	Input A&B AC Input Coupling Verification Points.....	4-13
4-5.	Volts Peak Measurement Verification Points	4-14
4-6.	Input A&B Frequency Measurement Accuracy Test	4-15
4-7.	Phase Measurement Verification Points	4-16
4-8.	Input A Trigger Sensitivity Test Points.....	4-18
4-9.	HF AC Voltage Verification Points	4-19
4-11.	HF AC Voltage Verification Points	4-21
4-12.	Meter Volts dc Measurement Verification Points.....	4-28
4-13.	Meter Volts AC Measurement Verification Points.....	4-29
4-14.	Resistance Measurement Verification Points.....	4-31
5-1.	Input A HF-LF Gain Calibration Points.....	5-9
5-2.	Input B LF-HF Gain Calibration Points	5-10
5-3.	Input A&B Gain Calibration Points	5-12
5-4.	Input A&B Gain Calibration Points	5-14
5-5.	DMM Gain Calibration Points	5-15
5-6.	Ohm Gain Calibration Points	5-17
7-1.	Starting Fault Finding.....	7-4
7-2.	Test Tool Key Matrix.....	7-12
7-3.	Meter Channel Control Line Status.....	7-15
8-1.	Final Assembly Parts.....	8-4
8-2.	Main PCA Unit Parts.....	8-6
8-3.	Main PCA Parts.....	8-8
8-4.	Standard Accessories.....	8-30
8-6.	Users Manuals	8-31
8-7.	Optional Accessories.....	8-31
9-1.	Source & Destination of Signals	9-4
9-2.	Location of Test Points on PCA Top Side	9-5
9-2.	Keyboard Layout.....	9-6
9-3.	Keyboard Layout.....	9-6



List of Figures

Figure	Title	Page
2-1	Max. Input Voltage vs. Frequency	2-16
2-2.	Safe Handling: Max. Input Voltage Between Scope References, Between Scope References and Meter Reference, and between Scope References/Meter Reference and ground.....	2-16
2-3.	Max Voltage from Probe Tip to Ground and from Probe Tip to Probe Reference	2-17
3-1.	Fluke190B-C Block Diagram	3-2
3-2.	Fluke 190B-C Start-up Sequence, Operating Modes	3-8
3-3.	C-ASIC OQ0260 Block Diagram.....	3-9
3-4.	LF Floating to Non-Floating	3-10
3-5.	C-ASIC Control Circuit.....	3-11
3-6.	Meter/Ext Channel Block Diagram	3-12
3-7.	S-ASIC signal section block diagram.....	3-15
3-8.	S-ASIC Input Circuit	3-16
3-9.	Trigger Circuit.....	3-17
3-10.	Keyboard Control Signals	3-21
3-11.	Power Supply Block Diagram	3-23
3-12.	CHAGATE Control Voltage	3-26
3-13.	REFPWM2 circuit.....	3-27
3-14.	Fly-Back Converter Current and Control Voltage	3-27
3-15.	Back Light Converter Voltages	3-29
4-1.	Menu item selection	4-4
4-3.	Test Tool Input A&B to 5500 Normal Output	4-7
4-4.	5500 Scope Output to Test Tool Input A&B	4-14
4-5.	5500A Scope Output to Test Tool Input A	4-16
4-7.	5500A Scope Output to Test Tool Input B.....	4-20
4-8.	Test Tool Input A to TV Signal Generator	4-22
4-9.	Trace for PAL/SECAM line 622.....	4-23
4-10.	Trace for NTSC line 525	4-23
4-11.	Trace for PAL/SECAM line 310.....	4-23
4-12.	Trace for NTSC line 262	4-23
4-13.	Test Tool Input A to TV Signal Generator Inverted	4-24
4-14.	Trace for PAL/SECAM line 310 Negative Video.....	4-24
4-15.	Trace for NTSC line 262 Negative Video.....	4-24
4-16.	Test Tool Input A to TV Signal Generator	4-25
4-17.	SC600 Marker Pulse.....	4-26
4-18.	Test Tool Meter/Ext Input to 5500A Normal Output	4-27
4-19.	Test Tool Input A to 5500A Normal Output 4-Wire.....	4-31
5-1.	Version & Calibration Data.....	5-3
5-2.	Display Test Pattern	5-7
5-3.	5500A SCOPE Output to Test Tool Input A.....	5-8
5-4.	5500A SCOPE Output to Test Tool Input B	5-10
5-5.	Test tool Input A&B to 5500 Scope Output.....	5-11
5-6.	Test tool Input A&B to 5500 Normal Output	5-13

5-7.	5500A NORMAL Output to Test Tool Banana Input.....	5-15
5-8.	Four-wire Ohms calibration connections	5-16
5-9.	10:1 Probe Calibration Connection	5-19
5-10.	10:1 Probe Calibration.....	5-19
6-1.	Loosen 2 Input Cover Screws.....	6-4
6-2.	Loosen 2 Bottom Holster Screws	6-4
6-3.	Opening the Test Tool.....	6-4
6-4.	Removing the Battery Pack	6-4
6-5.	Final Assembly Details.....	6-5
6-6.	Flex Cable Connectors	6-6
6-7.	PCA Unit Assembly	6-8
7-1.	Operative Test Tool without Case.....	7-4
7-2.	Supply voltages PCB TOP	7-10
7-3.	Supply voltages PCB bottom.....	7-10
8-1.	Final Assembly Details.....	8-5
8-2.	New version bottom cover.....	8-6
8-3.	Bottom cover old, NOT for 192B, 196B-C,-199B-C	8-6
8-4.	Main PCA Unit.....	8-7
8-5.	Rubber Spacer on Shielding Box Assy	8-7
9-1.	Scope Channel A	9-7
9-2.	Scope Channel B	9-8
9-3.	Meter/External TriggerChannel	9-9
9-4.	Sample & Trigger Circuit.....	9-10
9-5.	S-ASIC Supply	9-11
9-6.	ADC's	9-12
9-7.	Digital Control.....	9-13
9-8.	LCD Control & Supply Circuit	9-14
9-9.	Power Circuit.....	9-15
9-10.	Backlight, Slow ADC, Serial Interface	9-16
9-11.	OLD Main PCA Top View.....	9-17
9-12.	OLD Main PCA Bottom View	9-18
9-13.	NEW Main PCA Top View.....	9-19
9-14.	NEW Main PCA Bottom View	9-20
10-1.	PCA revision number sticker.....	10-3

Chapter 1

Safety Instructions

Title	Page
1.1 Introduction.....	1-3
1.2 Safety Precautions.....	1-3
1.3 Caution and Warning Statements.....	1-3
1.4 Symbols.....	1-3
1.5 Impaired Safety.....	1-4
1.6 General Safety Information.....	1-4

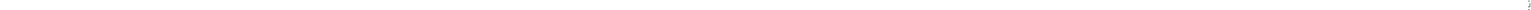

1.1 Introduction

Read these pages carefully before beginning to install and use the test tool.

The following paragraphs contain information, cautions and warnings which must be followed to ensure safe operation and to keep the test tool in a safe condition.

Warning

Servicing described in this manual is to be done only by qualified service personnel. To avoid electrical shock, do not service the test tool unless you are qualified to do so.

1.2 Safety Precautions

For the correct and safe use of this test tool it is essential that both operating and service personnel follow generally accepted safety procedures in addition to the safety precautions specified in this manual. Specific warning and caution statements, where they apply, will be found throughout the manual. Where necessary, the warning and caution statements and/or symbols are marked on the test tool.

1.3 Caution and Warning Statements

Caution











Used to indicate correct operating or maintenance procedures to prevent damage to or destruction of the equipment or other property.

Warning

Calls attention to a potential danger that requires correct procedures or practices to prevent personal injury.

1.4 Symbols

The following symbols are used on the test tool, in the Users Manual, in this Service Manual, or on spare parts for this test tool.

	See explanation in Users Manual		DOUBLE INSULATION (Protection Class)
	Live voltage		Earth Ground
	Static sensitive components (black/yellow).	 Ni MH	Recycling information
	Disposal information		Conformité Européenne
	Safety Approval		Safety Approval

1.5 Impaired Safety

Whenever it is likely that safety has been impaired, the test tool must be turned off and disconnected from line power. The matter should then be referred to qualified technicians. Safety is likely to be impaired if, for example, the test tool fails to perform the intended measurements or shows visible damage.

1.6 General Safety Information

Warning

Removing the test tool covers or removing parts, except those to which access can be gained by hand, is likely to expose live parts and accessible terminals which can be dangerous to life.

The test tool shall be disconnected from all voltage sources before it is opened.



Capacitors inside the test tool can hold their charge even if the test tool has been separated from all voltage sources.

When servicing the test tool, use only specified replacement parts.

Chapter 2

Characteristics

Title	Page
2.1 Introduction.....	2-3
2.2 Dual Input Oscilloscope.....	2-3
2.2.1 Isolated Inputs A and B (Vertical).....	2-3
2.2.2 Horizontal.....	2-4
2.2.3 Trigger and Delay.....	2-4
2.2.4 Automatic Connect&View Trigger.....	2-5
2.2.5 Edge Trigger.....	2-5
2.2.6 Isolated External Trigger.....	2-5
2.2.7 Video Trigger.....	2-5
2.2.8 Pulse Width Trigger.....	2-5
2.2.9 Continuous Auto Set.....	2-6
2.2.10 Automatic Capturing Scope Screens.....	2-6
2.3 Automatic Scope Measurements.....	2-6
2.3.1 General.....	2-6
2.3.2 DC Voltage (VDC).....	2-6
2.3.3 AC Voltage (VAC).....	2-6
2.3.4 AC+DC Voltage (True RMS).....	2-7
2.3.5 Amperes (AMP).....	2-7
2.3.6 Peak.....	2-8
2.3.7 Frequency (Hz).....	2-8
2.3.8 Duty Cycle (DUTY).....	2-8
2.3.9 Pulse Width (PULSE).....	2-8
2.3.10 Vpwm (C versions only).....	2-8
2.3.11 Power.....	2-9
2.3.12 Phase.....	2-9
2.3.13 Temperature (TEMP).....	2-9
2.3.14 Decibel (dB).....	2-9
2.4 Meter.....	2-10
2.4.1 Meter Input.....	2-10
2.4.2 Meter Functions.....	2-10

2.5 DMM Measurements on Meter Inputs.....	2-10
2.5.1 General.....	2-10
2.5.2 Ohms (Ω).....	2-10
2.5.3 Continuity (CONT).....	2-10
2.5.4 Diode.....	2-11
2.5.5 Temperature (TEMP)	2-11
2.5.6 DC Voltage (VDC).....	2-11
2.5.7 AC Voltage (VAC).....	2-11
2.5.8 AC+DC Voltage (True RMS).....	2-11
2.5.9 Amperes (AMP).....	2-12
2.6 Recorder.....	2-12
2.6.1 TrendPlot (Meter or Scope).....	2-12
2.6.2 Scope Record.....	2-12
2.7 Zoom, Replay and Cursors.....	2-13
2.7.1 Zoom.....	2-13
2.7.2 Replay.....	2-13
2.7.3 Cursor Measurements	2-13
2.8 Miscellaneous	2-13
2.8.1 Display.....	2-13
2.8.2  Power.....	2-13
2.8.3 Probe Calibration.....	2-14
2.8.4 Memory.....	2-14
2.8.5 Mechanical.....	2-14
2.8.6 Optical Interface Port.....	2-14
2.9 Environmental.....	2-14
2.10  Safety.....	2-15
2.11 10:1 probe VPS200.....	2-17
2.11.1 Safety.....	2-17
2.11.2 Electrical specifications.....	2-17
2.11.3 Environmental.....	2-17
2.12 Electromagnetic Immunity.....	2-18

2.1 Introduction

Performance Characteristics

FLUKE guarantees the properties expressed in numerical values with the stated tolerance. Specified non-tolerance numerical values indicate those that could be nominally expected from the mean of a range of identical ScopeMeter test tools.

Environmental Data

The environmental data mentioned in this manual are based on the results of the manufacturer's verification procedures.

Safety Characteristics

The test tool has been designed and tested in accordance with Standards ANSI/ISA S82.01-1994, EN 61010.1 (1993) (IEC 1010-1), CAN/CSA-C22.2 No.1010.1-92 (including approval), UL3111-1 (including approval) Safety Requirements for Electrical Equipment for Measurement, Control, and Laboratory Use.

This manual contains information and warnings that must be followed by the user to ensure safe operation and to keep the instrument in a safe condition. Use of this equipment in a manner not specified by the manufacturer may impair protection provided by the equipment.

2.2 Dual Input Oscilloscope

2.2.1 Isolated Inputs A and B (Vertical)

Bandwidth, DC Coupled	
FLUKE 199B-C.....	200 MHz (-3 dB)
FLUKE 196B-C.....	100 MHz (-3 dB)
FLUKE 192B.....	60 MHz (-3 dB)
Lower Frequency Limit, AC Coupled	
with 10:1 probe.....	<2 Hz (-3 dB)
direct (1:1).....	<5 Hz (-3 dB)
Rise Time (typical, calculated)	
FLUKE 199B-C.....	1.7 ns
FLUKE 196B-C.....	3.5 ns
FLUKE 192B.....	5.8 ns
Analog Bandwidth Limiters	20 MHz and 10 kHz
Input Coupling.....	AC, DC
Polarity.....	Normal, Inverted
Sensitivity Ranges C Versions, software V5.04 and higher	
with 10:1 probe.....	20 mV to 1000 V/div
direct (1:1).....	2 mV to 100 V/div
Sensitivity Ranges B Versions, and C versions software below V5.04	
with 10:1 probe.....	50 mV to 1000 V/div
direct (1:1).....	5 mV to 100 V/div
Trace Positioning Range.....	±4 divisions
Input Impedance on BNC	
DC Coupled.....	1 MΩ (±1 %)/15 pF (±2 pF)

⚠ Max. Input Voltage	
with 10:1 probe.....	600 V CAT III, 1000 V CAT II
direct (1:1)	300 V CAT III
	(For detailed specifications, see “Safety”)
Vertical Accuracy.....	±(1.5 % + 0.04 range/div) ±(2.5 % + 0.08 range/div) for 2 mV/div range
	For voltage measurements with 10:1 probe, add probe accuracy, see section ‘10:1 Probe’ on page 17
Digitizer Resolution.....	8 bits, separate digitizer for each input

2.2.2 Horizontal

Maximum Time Base Speed:	
FLUKE 199B-C.....	5 ns/div
FLUKE 196B-C.....	5 ns/div
FLUKE 192B.....	10 ns/div
Minimum Time Base Speed (Scope Record) .. 2 min/div	
Real Time Sampling Rate (for both inputs simultaneously):	
FLUKE199B-C:	
5 ns to 2 μs /div	up to 2.5 GS/s
5 μs to 120 s/div	20 MS/s
FLUKE 196B-C:	
5 ns to 2 μs /div	up to 1 GS/s
5 μs to 120 s/div	20 MS/s
FLUKE 192B:	
10 ns to 2 μs /div	up to 500 MS/s
5 μs to 120 s/div	20 MS/s
Record Length	
Scope Record Mode.....	≥ 27000 points on each input
Scope Normal Mode	≤ 1200 points on each input
Scope Glitch Capture Mode	300 min/max pairs on each input
Glitch Detection	
2 μs to 120 s/div.....	displays glitches as fast as 50 ns
Waveform Display.....	A, B, A+B, A-B, A*B, A vs. B Normal, Average (2,4,8,64x), Persistence
Time Base Accuracy.....	± (100 ppm + 1 pixel)

2.2.3 Trigger and Delay

Trigger Modes	Automatic, Edge, External, Video, Pulse Width
Trigger Delay.....	up to +1200 divisions
Pre Trigger View	one full screen length
Max. Delay	12 seconds

2.2.4 Automatic Connect&View Trigger

Source A, B, EXT
Slope Positive, Negative

2.2.5 Edge Trigger

Screen Update Free Run, On Trigger, Single Shot
Source A, B, EXT
Slope Positive, Negative
Trigger Level Control Range ± 4 divisions
Trigger Sensitivity A and B
DC to 5 MHz at >5 mV/div 0.5 divisions
DC to 5 MHz at 2 mV/div & 5 mV/div 1 division
200 MHz (FLUKE 199B-C) 1 division
250 MHz (FLUKE 199B-C) 2 divisions
100 MHz (FLUKE 196B-C) 1 division
150 MHz (FLUKE 196B-C) 2 divisions
60 MHz (FLUKE 192B) 1 division
100 MHz (FLUKE 192B) 2 divisions

2.2.6 Isolated External Trigger

Bandwidth 10 kHz
Modes Automatic, Edge
Trigger Levels (DC to 10 kHz) 120 mV, 1.2 V

2.2.7 Video Trigger

Standards PAL, PAL+, NTSC, SECAM
Modes Lines, Line Select, Field 1 or Field 2
Source A
Polarity Positive, Negative
Sensitivity 0.7 division sync level

2.2.8 Pulse Width Trigger

Screen Update On Trigger, Single Shot
Trigger Conditions $<T$, $>T$, $=T$ ($\pm 10\%$), $\neq T$ ($\pm 10\%$)
Source A
Polarity Positive or negative pulse
Pulse Time Adjustment Range 0.01 div. to 655 div.
with a minimum value of 300 ns ($<T$, $>T$) or 500 ns ($=T$, $\neq T$),
a maximum value of 10 s,
and a resolution of 0.01 div. with a minimum value of 50 ns.

2.2.9 Continuous Auto Set

Autoranging attenuators and time base, automatic Connect&View™ triggering with automatic source selection.

Modes

- Normal 15 Hz to max. bandwidth
- Low Frequency 1 Hz to max. bandwidth

Minimum Amplitude A and B

- DC to 1 MHz 10 mV
- 1 MHz to max. bandwidth 20 mV

2.2.10 Automatic Capturing Scope Screens

Capacity 100 dual input scope Screens

For viewing screens, see Replay function.

2.3 Automatic Scope Measurements

The accuracy of all readings is within \pm (% of reading + number of counts) from 18 °C to 28 °C. Add 0.1x (specific accuracy) for each °C below 18 °C or above 28 °C. For voltage measurements with 10:1 probe, add probe accuracy, see section '10:1 Probe' on page 17. At least 1.5 waveform period must be visible on the screen.

2.3.1 General

- Inputs A and B
- DC Common Mode Rejection (CMRR) >100 dB
- AC Common Mode Rejection >60 dB at 50, 60, or 400 Hz

2.3.2 DC Voltage (VDC)

- Maximum Voltage
 - with 10:1 probe 1000 V
 - direct (1:1) 300 V
- Maximum Resolution
 - with 10:1 probe 1 mV
 - direct (1:1) 100 μ V
- Full Scale Reading 1100 counts
- Accuracy at 5 s to 5 μ s/div \pm (1.5 % + 5 counts)
 \pm (1.5% + 10 counts) for 2 mV/div
- Normal Mode AC Rejection at 50 or 60 Hz ... >60 dB

2.3.3 AC Voltage (VAC)

- Maximum Voltage
 - with 10:1 probe 1000 V
 - direct (1:1) 300 V

Maximum Resolution	
with 10:1 probe.....	1 mV
direct (1:1).....	100 μ V
Full Scale Reading.....	1100 counts

Accuracy	
DC coupled:	
DC to 60 Hz.....	$\pm(1.5 \% + 10 \text{ counts})$
AC coupled, low frequencies:	
50 Hz direct (1:1).....	$\pm(2.1 \% + 10 \text{ counts})$
60 Hz direct (1:1).....	$\pm(1.9 \% + 10 \text{ counts})$

With the 10:1 probe the low frequency roll off point will be lowered to 2 Hz, which improves the AC accuracy for low frequencies. When possible use DC coupling for maximum accuracy.

AC or DC coupled, high frequencies:	
60 Hz to 20 kHz.....	$\pm(2.5 \% + 15 \text{ counts})$
20 kHz to 1 MHz.....	$\pm(5 \% + 20 \text{ counts})$
1 MHz to 25 MHz.....	$\pm(10 \% + 20 \text{ counts})$

For higher frequencies the instrument's frequency roll off starts affecting accuracy.

Normal Mode DC Rejection.....	>50 dB
-------------------------------	--------

All accuracies are valid if:

- The waveform amplitude is larger than one division
- At least 1.5 waveform period is on the screen

2.3.4 AC+DC Voltage (*True RMS*)

Maximum Voltage	
with 10:1 probe.....	1000 V
direct (1:1).....	300 V
Maximum Resolution	
with 10:1 probe.....	1 mV
direct (1:1).....	100 μ V
Full Scale Reading.....	1100 counts

Accuracy	
DC to 60 Hz.....	$\pm(1.5 \% + 10 \text{ counts})$
60 Hz to 20 kHz.....	$\pm(2.5 \% + 15 \text{ counts})$
20 kHz to 1 MHz.....	$\pm(5 \% + 20 \text{ counts})$
1 MHz to 25 MHz.....	$\pm(10 \% + 20 \text{ counts})$

For higher frequencies the instrument's frequency roll off starts affecting accuracy.

2.3.5 Amperes (*AMP*)

With Optional Current Probe or Current Shunt

Ranges	same as VDC, VAC, VAC+DC
Probe Sensitivity.....	100 μ V/A, 1 mV/A, 10 mV/A, 100 mV/A, 1 V/A, 10 V/A, and 100 V/A
Accuracy.....	same as VDC, VAC, VAC+DC (add current probe or -shunt accuracy)

2.3.6 Peak

Modes	Max peak, Min peak, or pk-to-pk
Maximum Voltage	
with 10:1 probe	1000 V
direct (1:1)	300 V
Maximum Resolution	
with 10:1 probe	10 mV
direct (1:1)	1 mV
Full Scale Reading.....	800 counts
Accuracy	
Max peak or Min peak	± 0.2 division
Peak-to-peak	± 0.4 division

2.3.7 Frequency (Hz)

Range	1.000 Hz to full bandwidth
Full Scale Reading.....	9 999 counts, with at least 10 waveform periods on screen.
Accuracy	
1 Hz to full bandwidth	$\pm(0.5 \% + 2 \text{ counts})$

2.3.8 Duty Cycle (DUTY)

Range	4.0 % to 98.0 %
-------------	-----------------

2.3.9 Pulse Width (PULSE)

Resolution.....	1/100 division
Full Scale Reading.....	999 counts
Accuracy	
1 Hz to full bandwidth	$\pm(0.5 \% + 2 \text{ counts})$

2.3.10 Vpwm (C versions only)

Purpose	to measure on pulse width modulated signals, like motor drive inverter outputs
Principle.....	readings show the effective voltage based on the average value of samples, over a whole number of periods of the fundamental frequency
Accuracy	as Vrms for sinewave signals

2.3.11 Power

Power Factor.....	ratio between Watts and VA
Range	0.00 to 1.00
Watt	RMS reading of multiplication corresponding samples Input A (volts) and Input B (amperes)
Full Scale Reading.....	999 counts
VA	$V_{rms} \times A_{rms}$
Full Scale Reading.....	999 counts
VA Reactive	$\sqrt{((VA)^2 - W^2)}$
Full Scale Reading.....	999 counts

2.3.12 Phase

Range	-180 to +180 degrees
Resolution.....	1 degree
Accuracy	
0.1 Hz to 1 MHz	± 2 degrees
1 MHz to 10 MHz.....	± 3 degrees

2.3.13 Temperature (TEMP)

With Optional Temperature Probe	
Ranges (°C or °F)	-40.0 to +100.0 ° -100 to +250 ° -100 to +500 ° -100 to +1000 ° -100 to + 2500 °
Probe Sensitivity.....	1 mV/°C and 1 mV/°F
Accuracy	as VDC (add temp. probe accuracy)

2.3.14 Decibel (dB)

dBV	dB relative to one volt
dBm	dB relative to one mW in 50 Ω or 600 Ω
dBon	VDC, VAC, or VAC+DC
Accuracy	same as VDC, VAC, VAC+DC

2.4 Meter

2.4.1 Meter Input

Input Coupling.....	DC
Frequency Response.....	DC to 10 kHz (-3 dB)
Input Impedance.....	1 M Ω (± 1 %)//10 pF (± 1.5 pF)
 Max. Input Voltage.....	1000 V CAT II, 600 V CAT III (For detailed specifications, see "Safety")

2.4.2 Meter Functions

Ranging.....	Auto, Manual
Modes.....	Normal, Relative

2.5 DMM Measurements on Meter Inputs

The accuracy of all measurements is within \pm (% of reading + number of counts) from 18 °C to 28 °C.

Add 0.1x (specific accuracy) for each °C below 18 °C or above 28 °C.

2.5.1 General

DC Common Mode Rejection (CMRR).....	>100 dB
AC Common Mode Rejection.....	>60 dB at 50, 60, or 400 Hz

2.5.2 Ohms (Ω)

Ranges.....	500.0 Ω , 5.000 k Ω , 50.00 k Ω , 500.0 k Ω , 5.000 M Ω , 30.00 M Ω
Full Scale Reading	
500 Ω to 5 M Ω	5000 counts
30 M Ω	3000 counts
Accuracy.....	\pm (0.6 % +5 counts)
Measurement Current.....	0.5 mA to 50 nA, ± 20 % decreases with increasing ranges
Open Circuit Voltage.....	<4 V

2.5.3 Continuity (CONT)

Beep.....	<50 Ω (± 30 Ω)
Measurement Current.....	0.5 mA, ± 20 %
Detection of shorts of.....	≥ 1 ms

2.5.4 Diode

Maximum Voltage Reading.....	2.8 V
Open Circuit Voltage.....	<4 V
Accuracy.....	$\pm(2\% + 5 \text{ counts})$
Measurement Current.....	0.5 mA, $\pm 20\%$

2.5.5 Temperature (TEMP)

With Optional Temperature Probe

Ranges (°C or °F).....	-40.0 to +100.0 ° ; -100.0 to +250.0 ° ; -100.0 to +500.0 ° ; -100 to +1000 ° -100 to + 2500 °
Probe Sensitivity.....	1 mV/°C and 1 mV/°F
Accuracy.....	as VDC (add temp. probe accuracy)

2.5.6 DC Voltage (VDC)

Ranges.....	500.0 mV, 5.000 V, 50.00 V, 500.0 V, 1100 V
Full Scale Reading.....	5000 counts
Accuracy.....	$\pm(0.5\% + 5 \text{ counts})$
Normal Mode AC Rejection.....	>60 dB at 50 or 60 Hz $\pm 1\%$

2.5.7 AC Voltage (VAC)

Ranges.....	500.0 mV, 5.000 V, 50.00 V, 500.0 V, 1100 V
Full Scale Reading.....	5000 counts
Accuracy	
15 Hz to 60 Hz.....	$\pm(1\% + 10 \text{ counts})$
60 Hz to 1 kHz.....	$\pm(2.5\% + 15 \text{ counts})$
For higher frequencies the frequency roll off of the Meter input starts affecting accuracy.	
Normal Mode DC Rejection.....	>50 dB

2.5.8 AC+DC Voltage (True RMS)

Ranges.....	500.0 mV, 5.000 V, 50.00 V, 500.0 V, 1100 V
Full Scale Reading.....	5000 counts
Accuracy	
DC to 60 Hz.....	$\pm(1\% + 10 \text{ counts})$
60 Hz to 1 kHz.....	$\pm(2.5\% + 15 \text{ counts})$
For higher frequencies the frequency roll off of the Meter input starts affecting accuracy.	
All accuracies are valid if the waveform amplitude is larger than 5 % of full scale.	

2.5.9 Amperes (AMP)

With Optional Current Probe or Current Shunt.

Ranges	same as VDC, VAC, VAC+DC
Probe Sensitivity	100 μ V/A, 1 mV/A, 10 mV/A, 100 mV/A, 1 V/A, 10 V/A, and 100 V/A
Accuracy	same as VDC, VAC, VAC+DC (add current probe or -shunt accuracy)

2.6 Recorder

2.6.1 TrendPlot (Meter or Scope)

Chart recorder that plots a graph of min and max values of Meter or Scope measurements over time.

Measurement Speed.....	> 5 measurements/s
Time/Div.....	5 s/div to 30 min/div
Record Size.....	18000 points
Recorded Time Span	60 min to 22 days (single reading) 30 min to 11 days (dual reading)
Time Reference.....	time from start, time of day

2.6.2 Scope Record

Records scope waveforms in deep memory while displaying the waveform in Roll mode.

Source	Input A, Input B
Max. Sample Speed (5 ms/div to 1 min/div) ...	20 MS/s
Glitch capture (5 ms/div to 1 min/div)	50 ns
Time/Div in normal mode	5 ms/div to 2 min/div
Record Size.....	27000 points per input
Recorded Time Span	6 s to 48 hours
Acquisition Modes.....	Single Sweep Continuous Roll External Triggering
Time Reference.....	time from start, time of day

Battery Charger / Power Adapter BC190:

- BC190/801 Universal European line plug 230 V \pm 10 %
 - BC190/803 North American line plug 120 V \pm 10 %
 - BC190/804 United Kingdom line plug 230 V \pm 10 %
 - BC190/806 Japanese line plug 100 V \pm 10 %
 - BC190/807 Australian line plug 230 V \pm 10 %
 - BC190/808 Universal switchable adapter 115 V \pm 10 % or 230 V \pm 10 %, with plug EN60320-2.2G
- Line Frequency 50 and 60 Hz.

2.8.3 Probe Calibration

Manual pulse adjustment and automatic DC adjustment with probe check.
Generator Output 3 Vpp / 500 Hz square wave

2.8.4 Memory

Number of Scope Memories 10
Each memory can contain two waveforms plus corresponding setups

Number of Recorder Memories 2
Each memory can contain:

- a dual input TrendPlot (2 x 9000 points)
- a dual input Scope Record (2 x 27000 points)
- 100 dual input Scope screens

2.8.5 Mechanical

Size 64 x 169 x 256 mm (2.5 x 6.6 x 10.1 in)
Weight 2 kg (4.4 lbs) including battery

2.8.6 Optical Interface Port

Via RS-232, optically isolated

To Printer

Supports Epson FX, LQ, HP Deskjet®, Laserjet®, and Postscript
Serial via PM9080 (optically isolated RS-232 adapter/cable, optional).
Parallel via PAC91 (optically isolated Print Adapter Cable, optional).

To PC/Notebook

Serial via PM9080 (optically isolated RS-232 adapter/cable, optional), using SW90W (FlukeView® software for Windows®).

2.9 Environmental

Environmental MIL-PRF-28800F, Class 2

Temperature

Operating:

battery operated 0 to 50 °C (32 to 122 °F)
power operated 0 to 40 °C (32 to 104 °F)

Storage -20 to +60 °C (-4 to +140 °F)

Humidity

Operating:

0 to 10 °C (32 to 50 °F)	noncondensing
10 to 30 °C (50 to 86 °F)	95 %
30 to 40 °C (86 to 104 °F)	75 %
40 to 50 °C (104 to 122 °F)	45 %

Storage:

-20 to 60 °C (-4 to 140 °F).....	noncondensing
----------------------------------	---------------

Altitude

Operating	3 km (10 000 feet)
Storage	12 km (40 000 feet)

Vibration (sinusoidal)..... max. 3 g

Shock

.....	max. 30 g
-------	-----------

Electromagnetic Compatibility (EMC)

Emission and immunity EN-IEC61326-1 (1997)

Enclosure Protection..... IP51, ref: IEC529

2.10  **Safety**

Designed for measurements on 1000 V Category II Installations, 600 V Category III Installations, Pollution Degree 2, per:

- ANSI/ISA S82.01-1994
- EN61010-1 (1993) (IEC1010-1)
- CAN/CSA-C22.2 No.1010.1-92
- UL3111-1

 Max. Input Voltages

Input A and B directly	300 V CAT III
Input A and B via 10:1 probe	1000 V CAT II, 600 V CAT III
METER/EXT TRIG inputs.....	1000 V CAT II, 600 V CAT III

 Max. Floating Voltage

from any terminal to ground	1000 V CAT II, 600 V CAT III
between any terminal.....	1000 V CAT II, 600 V CAT III

Voltage ratings are given as “working voltage”. They should be read as Vac-rms (50-60 Hz) for AC sinewave applications and as Vdc for DC applications.

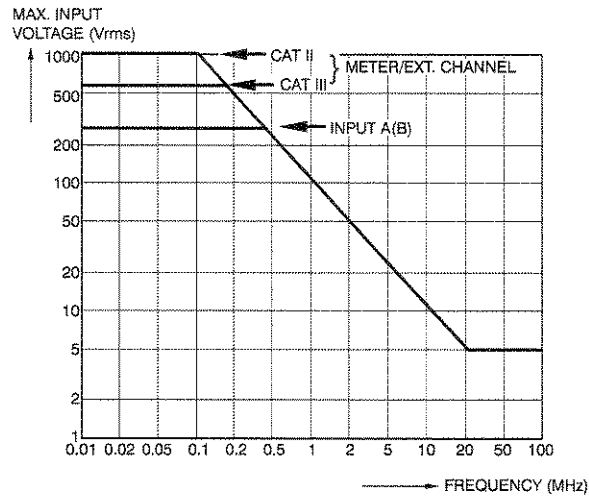

Figure 2-1. Max. Input Voltage vs. Frequency

190-volt-freq.wmf

Note

Overvoltage Category III refers to distribution level and fixed installation circuits inside a building. Overvoltage Category II refers to local level, which is applicable for appliances and portable equipment.

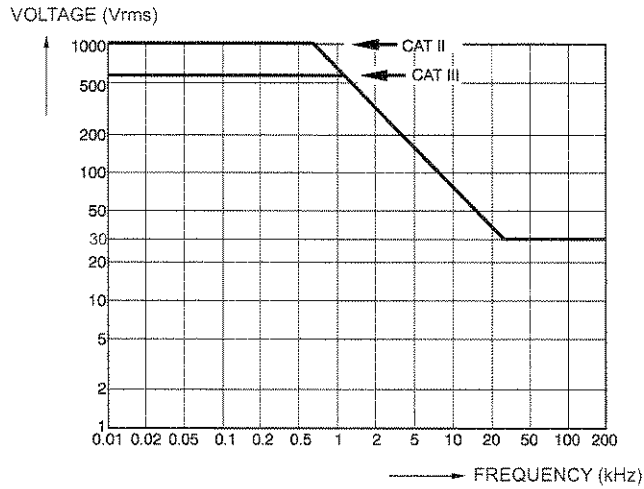

Figure 2-2. Safe Handling: Max. Input Voltage Between Scope References, Between Scope References and Meter Reference, and between Scope References/Meter Reference and earth ground

190-safe-handling.WMF

2.11 10:1 probe VPS200

2.11.1 Safety

⚠ Max. Input Voltage 1000 V CAT II, 600 V CAT III

⚠ Max. Floating Voltage
 from any terminal to ground 1000 V CAT II, 600 V CAT III

2.11.2 Electrical specifications

Input Impedance at probe tip 10 MΩ (±2 %)/14 pF (±2 pF)

Capacity Adjustment Range 10 to 22 pF

Attenuation at DC (1 MΩ input) 10 x

Bandwidth (with Fluke 199C) DC to 200 MHz (-3 dB)

Probe accuracy when adjusted on the test tool

DC to 20kHz 1%

AC 20kHz to 1MHz 2%

AC 1MHz to 25MHz 3%

For higher frequencies the probe's frequency roll off starts affecting the accuracy.

2.11.3 Environmental

Temperature

Operating 0 to 50 °C (32 to 122 °F)

Storage -20 to +60 °C (-4 to 140 °F)

Altitude

Operating 3 km (10 000 feet)

Storage 12 km (40 000 feet)

Humidity

Operating at 10 to 30 °C (50 to 86 °F) 95 %

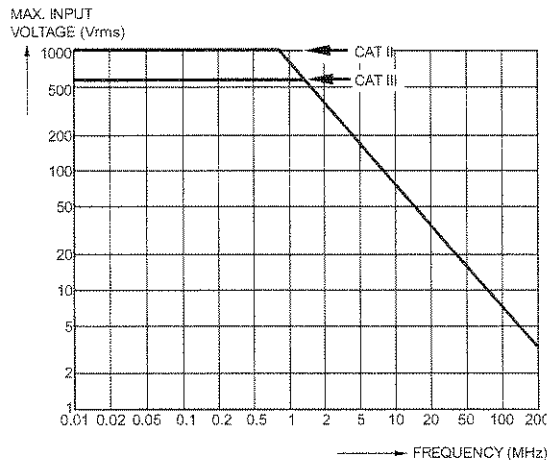

ST8696.WMF

Figure 2-3. Max Voltage from VPS200 Probe Tip to Ground and from VPS200 Probe Tip to Probe Reference

2.12 Electromagnetic Immunity

The Fluke 190 series, including standard accessories, conforms with the EEC directive 89/336 for EMC immunity, as defined by EN-61326-1, with the addition of the following tables.

Scope Mode (10 ms/div): Trace disturbance with VPS200 probe shorted

Table 2-1. Scope No Visible Disturbance at E=3 V/m

No visible disturbance	E = 3V/m
Frequency range 10 kHz to 20 MHz	2 mV/div to 100 V/div
Frequency range 20 MHz to 100 MHz	200 mV/div to 100 V/div
Frequency range 100 MHz to 1 GHz	500 mV/div to 100 V/div *)

*) With the 20 MHz Bandwidth Filter switched on: no visible disturbance
 With the 20 MHz Bandwidth Filter switched off: disturbance is max 2div.

Table 2-2. Scope Disturbance <10% at E=3 V/m

Disturbance less than 10% of full scale	E = 3V/m
Frequency range 20 MHz to 100 MHz	10 mV/div to 100 mV/div

Test Tool ranges not specified in tables 2-1 and 2-2 may have a disturbance of more than 10% of full scale.

Meter Mode (Vdc, Vac, Vac+dc, Ohm and Continuity): Reading disturbance with test leads shorted

Table 2-3. Meter Disturbance <1% at 3 V/m

Disturbance less than 1% of full scale	E = 3V/m
Frequency range 10 kHz to 1 GHz	500 mV to 1000 V , 500 Ohm to 30 MOhm ranges

Chapter 3

Circuit Description

Title	Page
3.1 Introduction	3-3
3.2 Block Diagram	3-3
3.3 Start-up Sequence, Operating Modes.....	3-7
3.4 Detailed Circuit Descriptions.....	3-9
3.4.1 Scope Channel A - Scope Channel B	3-9
3.4.2 Meter/Ext Trigger Channel.....	3-12
3.4.3 Sampling&Triggering (S-ASIC).....	3-15
3.4.4 S-ASIC supply	3-19
3.4.5 ADC's	3-19
3.4.6 Digital Control.....	3-20
3.4.7 LCD Control	3-22
3.4.8 Power	3-23
3.4.9 Slow ADC, RS232 Serial Interface, LCD Backlight.....	3-28

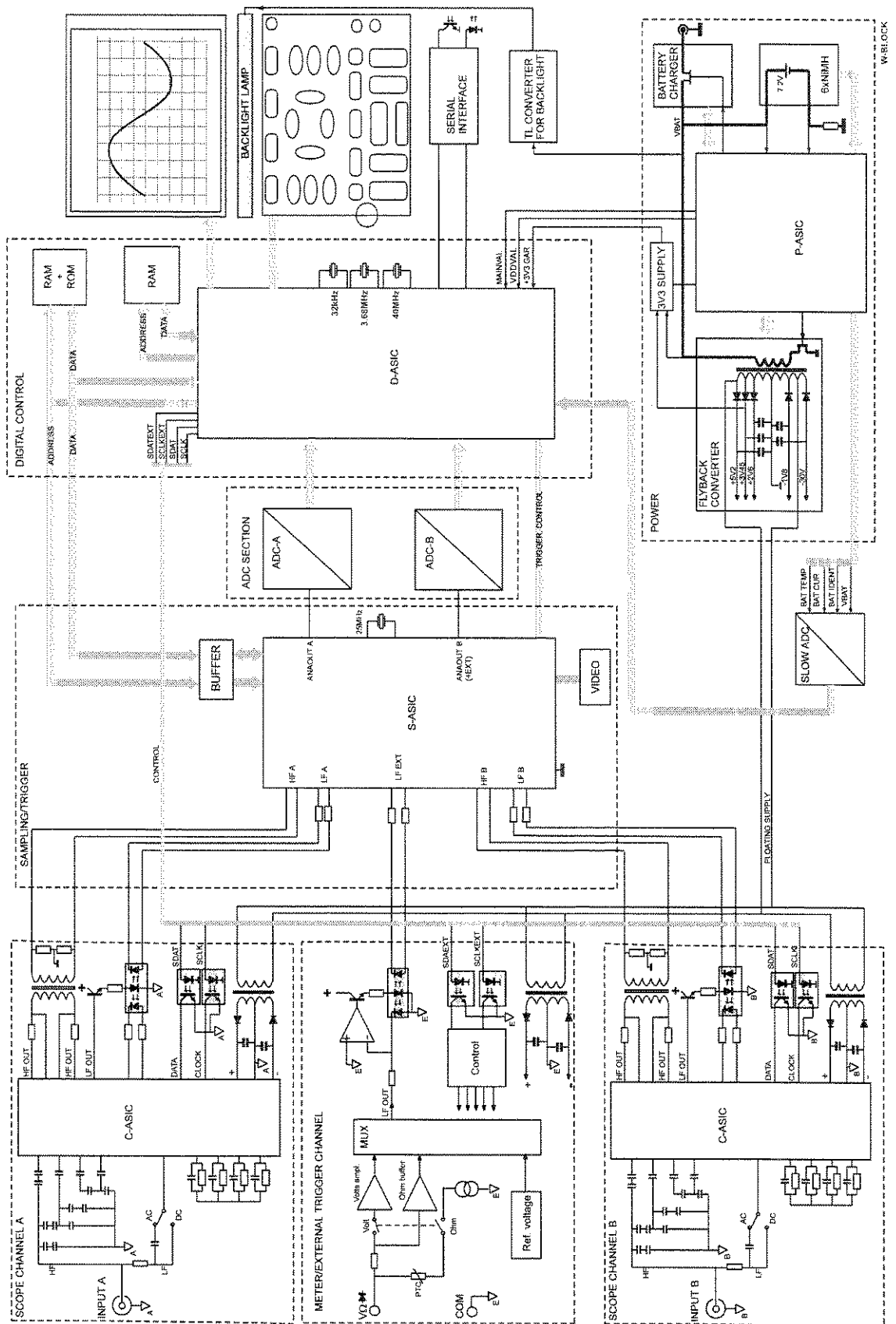

Figure 3-1. Fluke190B-C Block Diagram

W-BLOCK.WMF

3.1 Introduction

The Fluke 192B/196B-C/199B-C ScopeMeter test tools have three input channels that are electrically floating with respect to each other, and with respect to the power adapter input.

Channel A and channel B are oscilloscope channels with a 60/100/200 MHz bandwidth. The Meter/External Trigger channel is a combined DMM and external trigger channel with a limited (10 kHz) bandwidth.

The B versions have a black&white LCD, the C versions have a color display.

Section 3.2 describes the functional block diagram. It provides a quick way to get familiar with the test tool basic build-up.

Section 3.3 describes the test tool start-up sequence, and basic operating modes.

Section 3.4 describes the principle of operation of the test tool functions in detail, on the basis of the circuit diagrams.

3.2 Block Diagram

For the overall block diagram of the test tool see Figure 3-1. Fluke190B-C Block Diagram. The dashed frames indicate the division into the detailed circuit diagrams Figures 9-1 to 9-10.

Table 3-1 shows the main functions of the circuits in diagrams Figure 9-1 to 9-10.

Table 3-1. Fluke190B-C Main Functional Blocks

Circuit Diagram Name	Main Functions	Figure
SCOPE CHANNEL A	Scope Input A signal conditioning	9-1
SCOPE CHANNEL B	Scope Input B signal conditioning	9-2
METER/EXTERNAL TRIGGER CHANNEL	Multimeter Input signal conditioning External trigger input, probe calibration output signal	9-3
SAMPLING/TRIGGER	Sampling of conditioned input signals Trigger generation	9-4
S-ASIC SUPPLY, TRIGGER QUALIFIER EXTENDER	Filtering/de-coupling of various supply voltages for the S-ASIC Processing of trigger qualifier signal	9-5
ADC's,	Analog to Digital Conversion of the Input A and B, and Meter Input signals.	9-6
DIGITAL CONTROL	Acquisition of ADC samples Micro controller (μ P-ROM-RAM) Keyboard- and LCD control	9-7
LCD CONTROL/SUPPLY	LCD control signals buffer LCD supply voltages	9-8
POWER	Power supply , Battery charger	9-9
BACKLIGHT, SLOW ADC, SERIAL INTERFACE	TL converter for LCD backlight , Slow- ADC, Optical RS232 interface	9-10

All circuits, except the Liquid Crystal Display (LCD) unit and the KEYBOARD, are located on one Printed Circuit Assembly, called the MAIN PCA.

Many functions are incorporated in Application Specific Integrated Circuits (ASIC's). The ASIC's are referred to as C-ASIC (Channel ASIC), S-ASIC (Sampling ASIC), P-ASIC (Power ASIC), and D-ASIC (Digital ASIC).

Scope Channel A & B

The Scope Channel A and Scope Channel B circuit are identical.

An input voltage connected to the BNC input is supplied to the C-ASIC LF and HF path. The C-ASIC converts (attenuates, amplifies) the input voltage to a normalized HF voltage and a normalized LF output current.

The floating HF output voltage is transferred to the non-floating S-ASIC HF input path via a transformer.

The floating LF output current drives an optocoupler LED via a transistor. The resulting non-floating optocoupler photodiode current is converted into a voltage by the S-ASIC LF input path. An additional phototransistor is used for feed back of a copy of the non-floating LF signal.

The S-ASIC HF and LF input circuits convert the HF input voltage and the LF input current to one normalized signal. The S-ASIC samples this signal, stores the samples in an analog way, and supplies the samples to the ADC.

The D-ASIC acquires the digital equivalents of the samples to process them and show them on the display as traces and readings.

The D-ASIC provides the SDAT and SCLK control signals for the C-ASIC, e.g. to select the required attenuation factor, via optocouplers.

The C-ASIC supply voltages are supplied via a transformer.

Meter/External Trigger Channel

The input signal is connected to the banana jack inputs. The Meter/External trigger Channel bandwidth is 10 kHz.

Voltage measurements

The input voltage is attenuated by a factor 4, 40, 400 or 4000. The attenuated voltages are supplied to a de-multiplexer. Depending on the selected range, one of the de-multiplexer input voltages is supplied to an amplifier that drives the current in the photodiode of an optocoupler. The optocoupler phototransistor is sensed by the S-ASIC LF path. An additional phototransistor is used for feed back of the optocoupler transfer characteristic.

The S-ASIC LF input circuit converts the input current to a normalized signal. The S-ASIC supplies this signal to the ADC.

External triggering

The S-ASIC can also use the transferred input voltage for triggering if External Triggering is selected.

Resistance, continuity, and diode measurements

A current source supplies a current to the banana jack inputs via the Ohms relay and a protection PTC. The voltage drop across the connected resistance or diode is supplied to the de-multiplexer via the Ohm buffer (attenuation factor 1 or 10). The de-multiplexer supplies the voltage to a x1.2 amplifier, which drives the current in the photodiode of an optocoupler. From the measured voltage and supplied current the resistance value is calculated.

Control

The D-ASIC provides the SDATEXT and SCLKEXT control signals for the de-multiplexer and relays via optocouplers.

Probe calibration

By switching a current on and off, a 500 Hz square wave for probe calibration is generated.

Supply voltages

To achieve floating inputs, the supply voltages are supplied via a transformer.

Sampling/Trigger

The S-ASIC conditions the Channel A, Channel B circuit output signals, and samples them simultaneously at a maximum sample rate of 2.5 Giga Samples per second. The samples are stored in an internal analog memory array, and can be read out at a lower speed. The read out samples are supplied to the ADC's (ANAOUTA, ANAOUTB).

The Meter/External Trigger circuit output signal is conditioned, and passed by the S-ASIC to the Channel B ADC (not sampled in the S-ASIC).

The S-ASIC also contains the trigger circuitry. Scope Channel A, Scope Channel B, and the Meter/External Trigger Channel can be selected as trigger source. For video triggering a video synchronization separator IC (VIDEO) is installed.

ADC's

For the Channel A and Channel B signal an ADC is provided to convert the analog input signal into an 8-bit digital code. The Meter signal uses the Channel B ADC.

Digital Control

The D-ASIC includes a micro processor, ADC sample acquisition logic, trigger processing logic, display and keyboard control logic, I/O ports, and various other logic circuits.

The instrument software is stored in the FlashROM, the RAM is used for temporary data storage as processed ADC samples (traces).

The digitized Input A, Channel B, and Meter/Ext Channel input signals are acquired from the ADC's, and processed by the D-ASIC.

The D-ASIC supplies control data and display data to the LCD module. The LCD module consists of the LCD, LCD drivers, and a Cold Cathode FLuorescent (CCFL) back light lamp. As the module is not repairable, no detailed description and diagrams are provided. The back light supply voltage is generated by the back light TL converter on the MISCELLANEOUS CIRCUITS part.

The keys of the keyboard are arranged in a matrix. The D-ASIC drives the rows and scans the matrix. The ON-OFF key is not included in the matrix, but is sensed by a logic circuit in the D-ASIC that is continuously powered.

The D-ASIC sends control data to the C-ASIC's via the SCLK and SDAT serial control lines. The SDATEXT and SCLKEXT lines supply the control data for the Meter/External Trigger Channel.

The D-ASIC controls the Slow-ADC. Via the Slow ADC it reads the battery temperature, -voltage, -current, and -type.

The D-ASIC includes a UART (Universal Asynchronous Receiver Transmitter) for serial communication via the serial interface (RS232) circuit.

Power

The test tool can be powered by the BC190 Battery Charger/Power Adapter, or by the NiMH (Nickel Metal Hydride) battery pack.

If the power adapter voltage is present, it supplies the test tool power, and the battery charge current via the Charger circuit (VBAT voltage). The battery charge current is sensed, and controlled by the P-ASIC by changing the output current of the Charger circuit.

If the power adapter voltage is not present, the battery pack supplies the VBAT voltage.

The VBAT voltage supplies the P-ASIC power, and is also supplied to the Fly Back Converter (switched mode power supply).

If the test tool is turned on, the Fly Back Converter generates supply voltages for various test tool circuits. The Fly Back Converter is controlled by the P-ASIC.

The +3V3GAR supply voltage powers the D-ASIC, RAM, and FlashROM. If the test tool is turned off, the battery supplies the +3V3GAR voltage via the 3V3 Supply circuit. This circuit is controlled by the P-ASIC. So when the test tool is turned off, the D-ASIC can still control the battery charging process, the real time clock, the on/off key, and the serial RS232 interface (to turn the test tool on via the interface).

To monitor and control the battery charging process, the P-ASIC senses and buffers various battery signals, as temperature, voltage, and current. These signals are supplied to the Slow ADC to be measured by the D-ASIC. Using the results, the D-ASIC controls the battery charge current. The P-ASIC also contains circuits that can switch off the battery charging process if the charge conditions are not OK (e.g. temperature too high).

Miscellaneous

Slow ADC

Via the Slow ADC various analog signals can be measured by the D-ASIC, for example the battery voltage, battery type, battery temperature, and battery current. The signals are used for control purposes.

Back Light TL Converter

The Back Light TL Converter generates the **400V !** supply voltage for the LCD fluorescent back light lamp. If the lamp is defective a 1.5 kV voltage can be present for 0.2 second maximum.

RS232 Optically Isolated Serial Interface

Serial communication with a PC or printer is possible via the RS232 optically isolated interface.

The circuit converts the optical input signal (light or no-light) into a voltage which is supplied to the D-ASIC serial data input.

Serial data sent by the D-ASIC are converted into an optical signal (light or no-light).

3.3 Start-up Sequence, Operating Modes

The test tool sequences through the following steps when power is applied (see Figure 3-2 and Figure 9-9 (Power Circuit)).

1. The P-ASIC is directly powered by the battery or power adapter voltage VBAT (pin 60). Initially the Fly Back Converter is off, and the D-ASIC is powered by supply voltage +3V3GAR. The +3V3GAR voltage is derived from VBAT by the 3V3 Supply circuit (V4000).
If the voltage +3V3GAR is below 3.05V, the P-ASIC signals this to the D-ASIC pin 64(VDDVAL line low), and the D-ASIC will not start up. The test tool is not working, and is in the **Idle mode**.
2. If the voltage +3V3GAR is above 3.05V, the P-ASIC makes the line VDDVAL high, and the D-ASIC will start up. The test tool is operative now. If it is powered by **batteries only**, and **not turned on**, it is in the **Off mode**. In this mode the D-ASIC is active: the real time clock runs, and the ON/OFF key is monitored to see if the test tool will be turned on.
3. If the **power adapter is connected** (P-ASIC output pin 12 and MAINVAL high), **and/or the test tool is turned on**, the embedded D-ASIC program, called mask software, starts up. The mask software checks if valid instrument software is present in the Flash ROM. If not, the test tool does not start up and the mask software continues running until the test tool is turned off, or the power is removed. This is called the **Mask active mode**. The mask active mode can also be entered by pressing the up (^) and right (>) arrow key when turning on the test tool.

If valid instrument software is present, one of the following modes will become active:

Charge mode

The Charge mode is entered when the test tool is **powered by the power adapter, and is turned off**. The Fly Back Converter is off. The Charger circuit charges the batteries.

Operational & Charge mode

The Operational & Charge mode is entered when the test tool is **powered by the power adapter, and is turned on**. The Fly Back Converter is on, the Charger circuit supplies its primary current. The batteries will be charged.

Operational mode

The Operational mode is entered when the test tool is **powered by batteries only, and is turned on**. The Fly Back Converter is on, the batteries supply its primary current. If the battery voltage (VBAT) drops below 4V when starting up the fly back converter, the Off mode is entered.

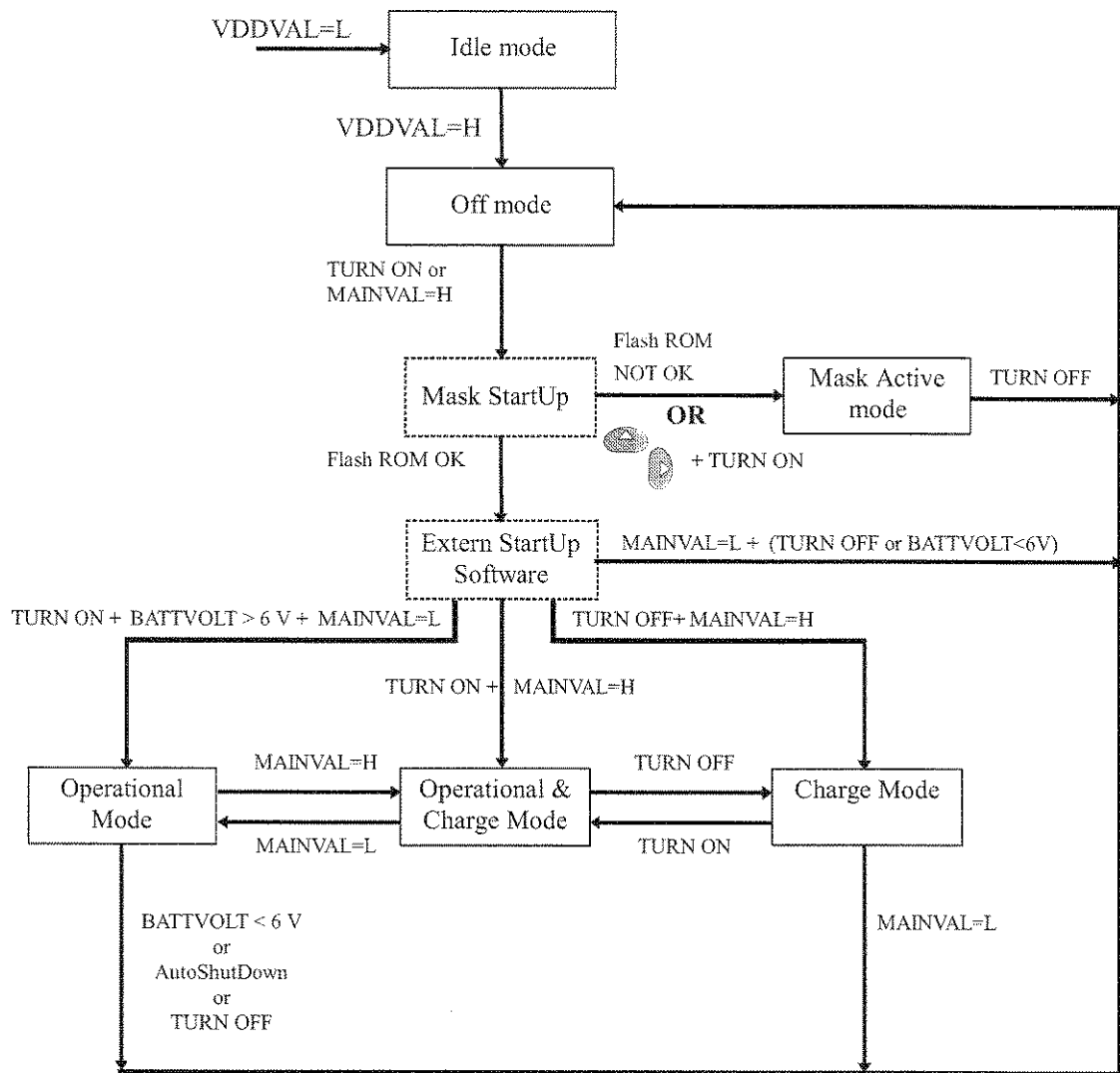

Figure 3-2. Fluke 190B-C Start-up Sequence, Operating Modes

190B-C-modes.wmf

Table 3-2 shows an overview of the test tool operating modes.

Table 3-2. Fluke190B-C Operating Modes

Mode	Conditions	Remark
Idle mode	No power adapter and no battery	no activity
Off mode	No power adapter connected, battery installed, test tool off	P-ASIC & D-ASIC powered (VBAT & +3V3GAR).
Mask active mode	No valid instrument software, or ^ and > key pressed when turning on	Mask software runs
Charge mode	Power adapter connected and test tool off	Batteries will be charged
Operational & Charge mode	Power adapter connected and test tool on	Test tool operational, and batteries will be charged
Operational mode	No power adapter connected, battery installed, and test tool on	Test tool operational, powered by batteries

3.4 Detailed Circuit Descriptions

Note:

Capacitors of 0 pF, and resistors of 100 M Ω shown in circuit diagrams are not placed on the PCA. They are drawn in the circuit diagrams for PCA layout purposes. In the layout design process they create locations on the PCA where capacitors or resistors can be placed.

3.4.1 Scope Channel A - Scope Channel B

See circuit diagrams Figure 9-1 and Figure 9-2.

As the Scope Channel A and B circuits are identical, a description is given for Scope Channel A only.

The Channel A/B circuitry is built-up around a C-ASIC OQ0260. The C-ASIC is placed directly behind the input BNC, and does the analog signal conditioning for the channel.

The C-ASIC OQ0260

Figure 3-3 shows the simplified block diagram of the OQ0260 C-ASIC. The C-ASIC consists of separate input paths for HF and LF signals, an output stage that drives separate HF and LF isolation facilities, and a control block that allows software control of all modes and adjustments. The transition frequency from the LF input path to the HF input path is approximately 10 kHz. The transition frequency of the HF and LF output signal is 25 kHz.

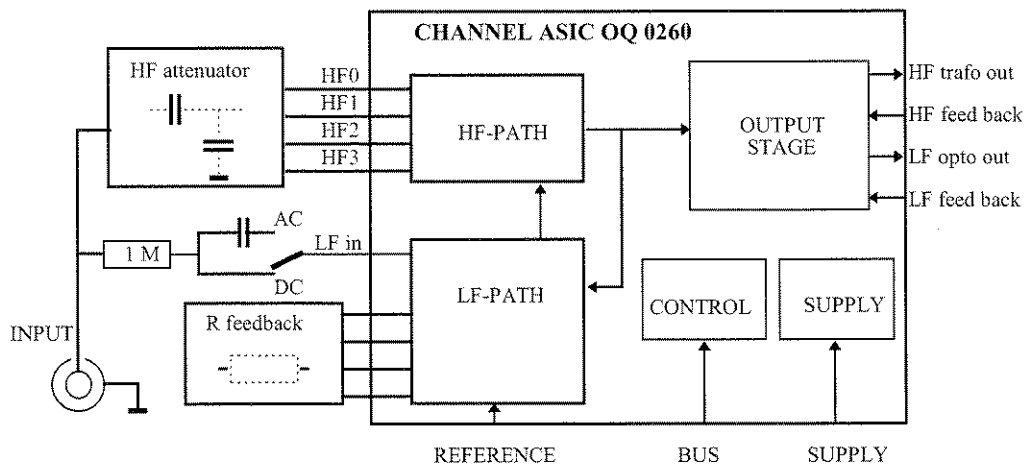

Figure 3-3. C-ASIC OQ0260 Block Diagram

LF input

The LF-input (pin 59) is connected to a LF decade attenuator consisting of an inverting amplifier with switchable external feedback resistors R1031 to R1034. Depending on the selected range the LF attenuation factor which will be set. The input of the LF attenuator is a virtual ground, which is connected to the BNC input via a 1 M Ω resistor (R1050...R1052). The LF decade output signal is supplied to a gain adjust stage, and then added to the HF path output signal. The resulting signal is supplied to the C-ASIC output stage.

The AC/DC input coupling relay K1000 is controlled by C-ASIC output ACDC (pin 61), and V1004. The Input B relay is mounted reverse with respect to the Input A relay, and

has reverse control pulses!

Resistor R1053 limits the discharge current of C1050 when switching from AC coupled to DC coupled input. At AC coupled input, the maximum voltage across C1050 is limited by voltage divider:

$$(10\text{ M}\Omega \text{ of } 10:1 \text{ probe if connected}) + R1050 + R1051 + R1052 / R1055 + R1056.$$

HF input

The HF component of the input signal is connected to a HF decade attenuator via C1001-C1002 (:1) and C1003-C1004 (attenuated). The HF decade attenuator contains four separate current input amplifiers, which are connected to external capacitive dividers: HF0 (:1), HF1 (:10), HF2 (:100), HF3 (:1000). Only one amplifier is active at a time. Inputs of inactive input buffers are internally connected to ground to eliminate crosstalk. To control the DC bias of the buffers inputs, the HF output path voltage is fed back via resistors R1010, R1001, R1002, R1003, and R1004. To obtain a large HF gain filter R1000/C1000 eliminates HF feed back. The HF attenuator output voltage is supplied to a HF pre-amplifier with switchable gain factors, and then to a gain adjust stage. Finally the HF signal is added to the LF signal. The resulting signal is supplied to the C-ASIC output stage.

Output Stage

The output stage splits the combined HF/LF input signal into a LF and a HF part.

LF output signal

The LF output signal drives a current in the LED of an optocoupler (H1120) via transistor V1120 (output pin 30). For stability the V1120 emitter voltage is fed back to the LF output driver (CLED pin 28). The current in the optocoupler photodiode is converted into a voltage by R1136 and R1133. This voltage (LFA1, LFA2) is measured by a differential amplifier in the S-ASIC (see 3.4.3 Acquisition Section).

A copy of the LF output signal is fed back to the C-ASIC to optimize the overall frequency response flatness and to optimize the LF path linearity. The current in the second optocoupler photodiode is converted into a voltage by R1123 and R1124. The voltage (pin 34 and 35) is measured by a differential amplifier in the C-ASIC. The output signal of the amplifier is fed back via filter R1122/C1125.

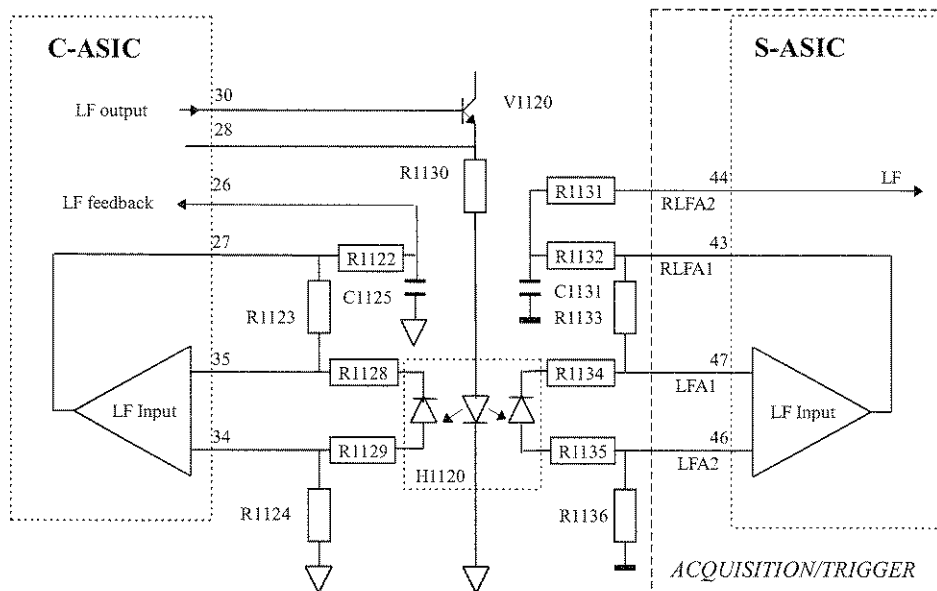

Figure 3-4. LF Floating to Non-Floating

al-float.wmf

HF output signal

The HF output signal supplies a voltage to the primary side of HF transformer T1100 (C-ASIC pin 40, 41). This voltage is proportional to the input voltage. The voltage at the secondary side of the transformer is referred to the non-floating ground level via R1110, R1111, etc. The secondary voltage (HFA1, HFA2) is supplied to the sampling system S-ASIC (see 3.4.3 Acquisition Section).

Any HF output DC offset is fed back to C-ASIC pin 32,33 to be eliminated. This prevents saturation and distortion in the HF transformer.

Feedback of the HF signal via C-ASIC pin 37, 38 minimizes the LF-HF turn over error.

Due to the parasitic capacitance between the primary and secondary transformer windings, large common mode input voltage steps can cause voltage spikes on the transformer lines. Diodes V1100...1105 will clamp these spikes to the supply voltage. Circuit V1106/C1112/R1112-R1116 limits the consequences of fast common mode voltage spikes caused by for example motor control systems.

Calibration signals (PWMA, CALOUTA)

The PWM output (pin 21) supplies a pulse width modulated square wave to filter/attenuator C1039-R1046-R1068-C1045. By changing the square wave duty cycle, a linear ramp is created for linearization during the pre-cal stage of the calibration. The ramp voltage (LINA) is supplied to pin 62 of the C-ASIC. The PWM output control pulses are supplied by the D-ASIC SDATFLT line to C-ASIC input pin 22 (FASDAT line) via the C-ASIC CONTROL LINEARIZATION circuit (see Figure 9-4). See also below Control - Linearization.

The CALOUT output (pin 49) supplies a -0.5V or +0.5V voltage to the CALSIG input (pin 53) via R1065, R1049, and R1041 for dynamic (that is periodical during normal operation) gain calibration. The CALOUT voltage is derived from the 1.225V reference diode voltage VREFPA at pin 47.

Control - Linearization

Control information for the C-ASIC, for example selection of the attenuation factor, is sent via the SDATFLT data line to optocoupler H1150. The D-ASIC SCLK line controls the synchronization clock signal SCLKFLT. Optocoupler H1150 transfers the non-floating control signals to the floating C-ASIC.

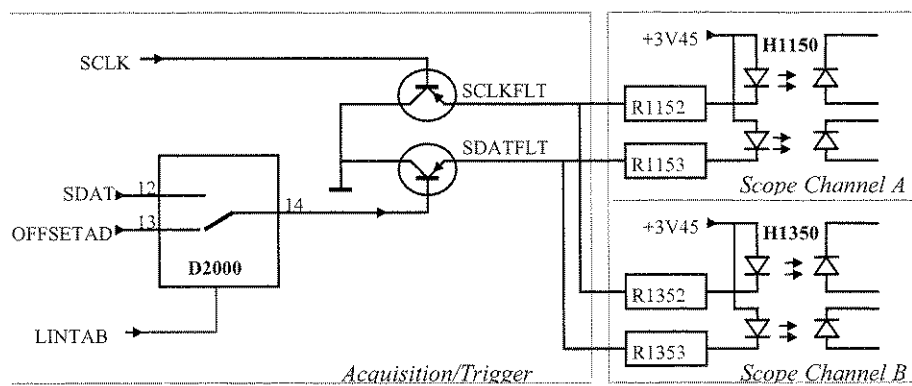

Figure 3-5. C-ASIC Control Circuit

D2000 on the C-ASIC CONTROL LINEARIZATION circuit (see Figure 9-4) connects the SDATFLT line to the D-ASIC SDAT data line, or to the D-ASIC OFFSETAD line. The SDAT line provides the control data to change the C-ASIC settings. The OFFSETAD line provides a Pulse Width Modulated signal that is used for linearization

of the C-ASIC during calibration.

Signal LINTAB, supplied by the D-ASIC, controls whether D2000 input pin 12 or 13 is connected to output pin 14.

IREF

A 100 μ A reference current into pin 48 is derived via R1083 from reference diode voltage VREFPA (V1010) for biasing internal C-ASIC circuits.

Supply Voltages

When the test tool is on, the Fly Back Converter on the POWER circuit supplies the primary voltage for supply transformer T1102. The floating secondary voltages are rectified, filtered, and supplied to the C-ASIC.

3.4.2 Meter/Ext Trigger Channel

See Figure 3-6. Meter/Ext Channel Block Diagram, and Circuit Diagram Figure 9-3.

The Meter/Ext Channel can measure voltages up to 1000V, resistance up to 30 M Ω , continuity, and diode voltage. It provides no trace but only readings, except in the Trendplot mode. The input is always DC coupled, and the channel has a limited bandwidth of 10 kHz. The Meter/Ext Channel input is floating with respect to Input A and Input B, and with respect to the power supply ground.

The channel can also be used as external trigger input, and as a probe cal generator.

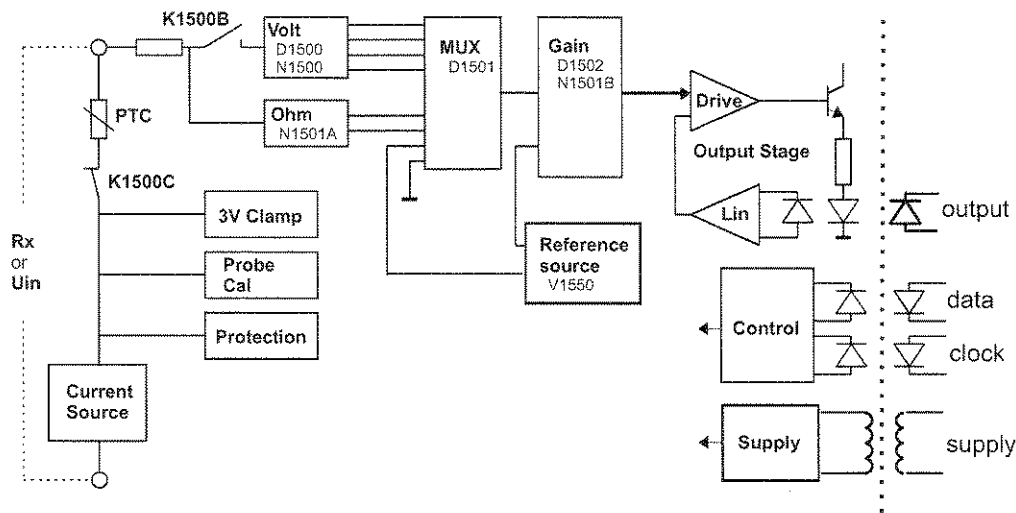

win-ex-block.wmf

Figure 3-6. Meter/Ext Channel Block Diagram

Section 7.5.7 provides a table that shows the control line status for all meter channel functions.

Voltage Measurements

The input voltage U_{in} is applied to the “volts” attenuation stage via K1500B. This stage consist of opamp N1500 , switch D1500 and resistors R1504-R1507. Possible attenuation factors are :4 (R1504), :40 (R1505), :400 (R1506), and :4000 (R1507). Switch D1501 connects one of the attenuator outputs (pin 1,5,2,4) to the “gain” stage (see below).

Ohms/Continuity/Diode Measurements

A current source (see below) supplies a constant current to the unknown resistance R_x connected to the banana input X1000C pin 5. The current flows via K1500C and PTC resistor R1535. The voltage across the unknown resistor is supplied to the “ohms” buffer N1501A pin 3. The buffered voltage is supplied to D1501 pin 15 (for ranges up to 5 M Ω). For the 30 M Ω range a :10 voltage is supplied to D1501 pin 14. Switch D1501 supplies the “ohms” voltage to the “gain” stage (see below).

In Ohms C1550 is connected to the current source via D1500B pin 11-13 to limit hum influences, specially in the 30 M Ω range

Continuity measurements and diode measurements use a current of 0.5 mA.

External Triggering

In the External trigger mode the input signal is supplied to the output stage via K1500B, volts attenuator path :4 (R1504, trigger level 120 mV) or :40 (R1505, trigger level 1.2 V), and D1501 pin 1 to 3 or pin 5 to 3.

Reference Source V1550

A +250 mV reference voltage derived from diode V1550 is supplied to D1501 pin 13.

A -250 mV reference voltage is derived from V1550 via R1511-R1509, D1502 pin 14-3, and N1501.

During measuring, occasionally the reference voltage, and the ground (D1501 pin 12) are sensed for calibration.

The -250 mV reference is also added to the Ohms voltage via the gain stage, see “gain stage”.

Gain Stage

The gain stage consists of opamp N1501B, switch D1502, and R1508-R1512. It provides:

- a x1 gain for diode measurements, zero calibration, positive reference voltage measurement (internal calibration), and probe calibration (D1502 pin 3 to 1,2,4,5).
- a gain factor x2 in the Volts mode (D1502 pin 3 to pin 13)
- a gain factor 1.2 for the Ohms voltage plus an offset voltage of -0.25 V (D1502 pin 3 to pin 14). By adding the negative offset, a large (line) interference voltage does not cause the hardware to clamp. The software will “filter” the interference voltage.
- a gain factor 6 in the External trigger mode.

Output Stage

The voltage at N1501B pin 7 controls the current in the H1525 LED via opamp N1525B and transistor V1525. Via H1525 pin 5-6 the signal is transferred to the S-ASIC LF input (LFEXT1, LFEXT2). The operation is identical to the Input A LF input (see 3.4.1).

Feedback of the LF signal via diode H1525 pin 3-4 and N1525 provides good linearity. The clamp circuits N1515A,B and related parts limit the output voltage to + or - 150 mV. This prevents the S-ASIC and ADC from being overloaded.

Current Source

Reference diode V1555 provides a 1.2 V reference voltage with respect to +5VEXT.

For the 50 nA current (Ohms ranges 5 M Ω and 50 M Ω), the switches in D1560 are all open. In this case the reference voltage is lowered by a factor 10 by R1556-R1557. The

50 nA current flows via R1558+R1559 and FET V1560 to the input terminal X1000C pin 5. The voltage drop across R1558+R1559 is controlled by feeding it back to the inverting input of N1540B via R1560.

For the higher currents the switches in D1560 are closed in pairs. For the 0.5 mA current D1560 pin 3 is connected to pin 1, and pin 13 is connected to 12. Now R1560 is shorted. The 0.5 mA current flows from +5VEXT, via R1561, D1560, and FET V1560 to the input terminal X1000C pin 5. The voltage drop across R1561 is fed back to N1540B pin 6. The other currents can be set by connecting resistors R1562 (500 μ A), R1563 (50 μ A), and R1564+R1565+R1565 (5 μ A).

Ohms Input Protection and Clamp

When a voltage is applied to the input in the Ohms function V1535, V1536 and V1537 will limit the voltage on the current source. The resulting current is limited by PTC resistor R1535. Under normal conditions the voltage across V1535-V1536 is made zero by buffer amplifier N1540; this prevents measurement errors due to leakage.

The "open input" voltage is limited to about 4 V by FET V1544. The V1544 gate is set to 3 V by N1541 output pin 1. The FET acts as a low leakage diode.

Probe Calibration Output

For DC probe calibration the current source supplies 0.5 mA to R1544 via D1500 pin 13 to pin 12. The resulting 3.1 V is supplied to the red banana input terminal. The voltage is measured by the Meter channel via the Ohms circuit N1501, D1501 pin 14 to 3, etc. The voltage is also measured via the connected probe by Scope channel A or B. From the two measured values a probe correction factor is calculated and applied.

For AC probe adjustment D1572D, R1538 and C1538 generate a 1 kHz square wave voltage on D1572D pin 11. This voltage alternately connects D1500 pin 13 to pin 14 (ground) and pin 12 (R1544). The 0.5 mA current will now result in a 500 Hz 3 V square wave on the red banana input terminal.

Control

Control data and clock signal are supplied to optocoupler H1580 by the D-ASIC (pin P1 and P2) via the SDATEXT data line and the SCLKEXT clock line. The output data and clock are supplied to pulse shapers D1572. Data are shifted into registers D1570 and D1571 on CLK0 (D1572 pin 3). After the last data bit has been shifted into the register, the clock signal CLK is kept low. Now the shift register strobe input signal (D1572 pin 6) goes high and the data appear at the outputs.

Meter Channel linearization

(see C-ASIC CONTROL LINEARIZATION in Figure 9-4)

If the D-ASIC makes line LINTAB (D2000 pin 9,10,11) high, D2000 pin 1 and 15 are interconnected, and D2000 pin 3 and 4 are interconnected. The D-ASIC PWM output signal OFFSETAD is supplied to integrating amplifier N2000. Via D2000 pin 3-4, the resulting analog output voltage is supplied to the S-ASIC Meter/Ext channel input (N2001 pin 59 LFEXT2). This voltage is used for linearization of the Meter channel during calibration.

Supply Voltages

The supply voltages are provided by the Fly Back Converter on the POWER circuit via transformer T1575.

3.4.3 Sampling&Triggering (S-ASIC)

See circuit diagram Figure 9-4.

The core of the Sampling&Triggering section is the S-ASIC, which includes a signal processing section and a trigger processing section.

Signal path

See Figure 3-7. S-ASIC signal section block diagram and Figure 3-8. S-ASIC Input Circuit.

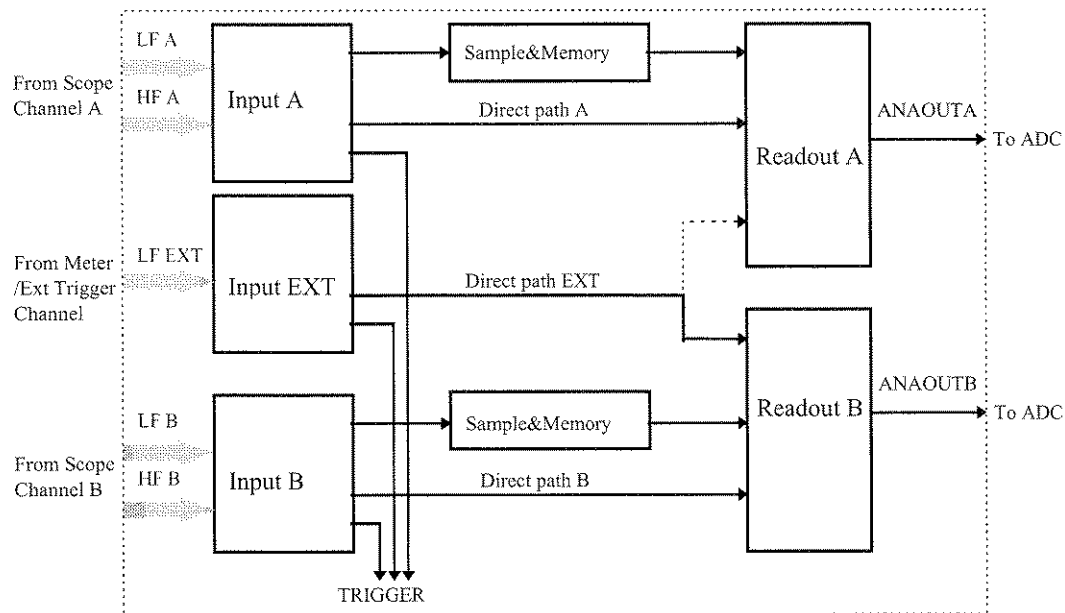

Figure 3-7. S-ASIC signal section block diagram

The S-ASIC has the analog input circuits:

1. Input A, for the Scope Channel A HF and LF signals
2. Input B, for the Scope Channel B HF and LF signals
3. Input EXT for the Meter/External Trigger Channel LF signal

The three analog input circuits are identical, except the input EXT circuit that has no HF input. These circuits convert the LF current input signal and the HF voltage input signal into one combined HF+LF signal.

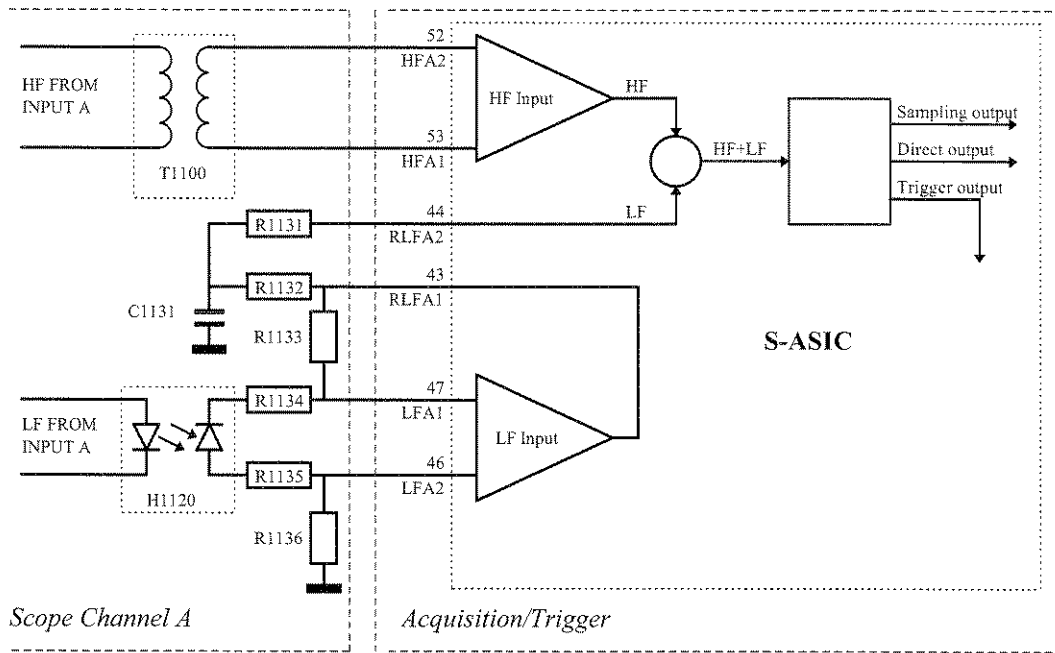

Figure 3-8. S-ASIC Input Circuit

The LF output from the Channel A circuit (see section 3.4.1) controls the current in the LED of H1120. The resulting current in the H1120 photodiode is 5 $\mu\text{A}/\text{div.}$, and is converted into a voltage by R1136 and R1133. This voltage (LFA1, LFA2) is measured by a differential amplifier in the S-ASIC. The output signal RLFA1 is supplied to the LF/HF adding point via filter R1132/C1131. For the Meter/Ext input the photodiode (H1525) current is 2.5 $\mu\text{A}/\text{div.}$

The HF output from the input A circuit is supplied to transformer T1100. The secondary transformer voltage is 30 $\text{mV}/\text{div.}$, and supplied to a differential voltage input of the S-ASIC (HFA1, HFA2).

The S-ASIC input circuits provide three types of output signals to other internal S-ASIC circuits:

- A current output for the Sample&Memory circuits (not for the Input EXT circuit)
- A voltage output routed directly to the Readout circuit (Direct Path)
- A voltage output for triggering (see Trigger Path below).

The S-ASIC includes a 10 kHz and a 20 MHz bandwidth limiting circuit (C2000 - C2002). For the scope inputs these circuits can be turned on/off via the Input A/B OPTIONS menu.

Sample&Memory

The current output signal supplied to the Sample&Memory circuit represents the measurement signal. The Sample&Memory circuit can operate in two modes, the TCM (Time Conversion Mode) and the WARS (Write And Read Simultaneously) mode.

In time base settings 2 $\mu\text{s}/\text{div}$ and faster, the TCM is active. The circuit samples the Input A(B) circuit output current using a high speed current switch. The current samples are converted into voltages by loading various memory capacitors with a current sample. Up to 3000 input signal samples can be stored at a maximum sample rate of 2.5×10^3 samples per second. The sampling clock is generated in the S-ASIC PLL (Phase Locked

Loop). The PLL is synchronized with the external crystal B2000.
The Readout circuit can output the memory capacitor voltages one after another at a lower speed.

In time base setting slower than 2 μ s/div the WARS mode is active. The Input A(B) circuit output signal is sampled at a speed of 20 MS/s (MegaSamples per second). The samples are directly available on the sample and memory output.

Direct path

The Direct Path voltage output supplies the combined HF-LF signal directly to the Readout circuit. The Input A and Input B direct path monitors the input signal. The monitored signal is not given as a measurement result, but is used for control purposes as for example autoranging.

Readout circuits

The input EXT direct path uses the Readout B circuit.

Low temperature coefficient resistors R2050 and R2034 are connected to the S-ASIC Readout stage to obtain a temperature independent current-to-voltage conversion.

The output voltages of the Readout circuits (pin 2 ANAOUTA, pin 119 ANAOUTB) are supplied to an ADC at an output rate of maximal 20 MS/s (CLKJILL to pin 133, see below CLOCK Signals).

The REFADCT reference voltage is supplied to the top of the ADC resistor ladders. To improve the METER accuracy in the WARS mode, a generator in the S-ASIC adds a dither voltage to the measurement signal. Control signals for the generator are RAMPCLK (pin 131) and RSTRAMP (pin 129).

The METER/EXT channel uses the same ADC as the Scope Channel B.

Trigger Path

See Figure 3-9. Trigger Circuit for the functional block diagram of the trigger circuit.

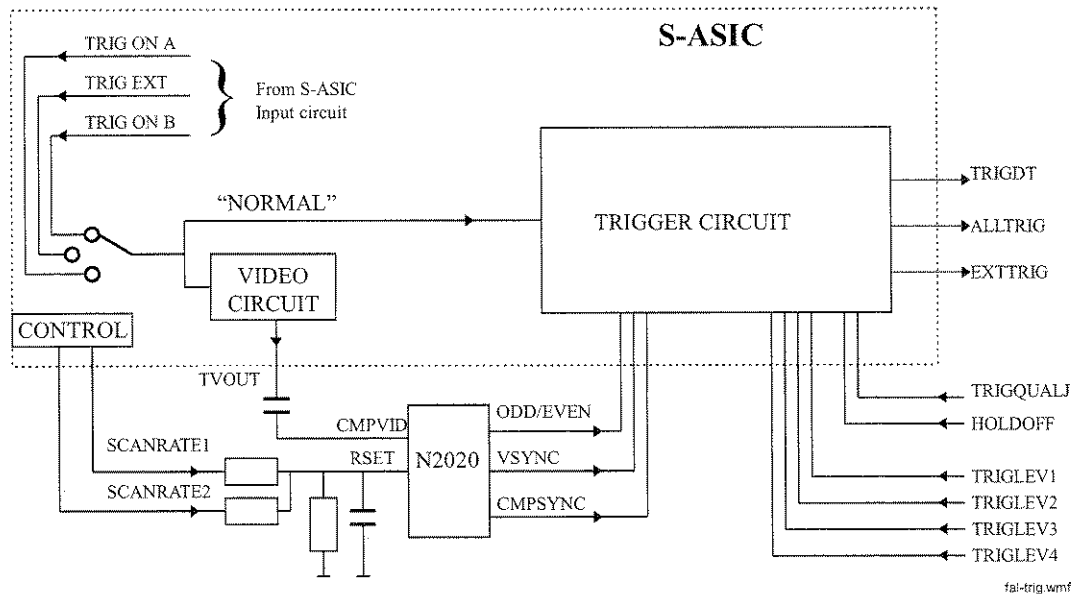

Figure 3-9. Trigger Circuit

Depending on the test tool trigger source setting, one of the S-ASIC Input Circuit trigger output signals TRIGEXT, TRIGONB or TRIGONA is supplied to the S-ASIC trigger circuit.

For VIDEO triggering, the trigger signal (composite video) is supplied to the VIDEO CIRCUIT that removes chroma and video information. The output is supplied to the Video Sync separator IC N2020. This IC extracts timing information from the composite sync signal. Used output signals are Odd/Even field, Composite Sync, and Vertical Sync. By changing the current level at the RSET input, the N2020 can be adjusted for video signals with line scan frequencies from 15.625 Hz to 15.750 kHz. For this purpose, the lines SCANRATE1 and SCANRATE2 can be floating or be connected to ground by the CONTROL circuit. The output signals are supplied to the S-ASIC trigger circuit. Only Input A provides Video triggering.

For "NORMAL" triggering, one of the signals TRIGEXT, TRIGONB or TRIGONA is directly supplied to the trigger circuit.

The trigger circuit has two trigger input circuits (TRIGLEVA and TRIGLEVB) that each can compare the input signal to the set trigger levels (TRIGLEV1A-TRIGLEV2A, and TRIGLEV1B-TRIGLEV2B). The analog trigger level voltages are supplied by the D-ASIC by means of filtered PWM (Pulse Width Modulated) signals. Each trigger input circuit generates a trigger signal if the input signal crosses the trigger levels. To prevent triggering on noisy signals a large trigger gap can be created by setting the two trigger levels of each trigger input circuit.

The trigger circuit provides three output signals:

- ALLTRIG includes all triggers (all trigger level crossings).
- TRIGDT gives the final acquisition trigger for the D-ASIC in WARS mode, and is not used in TCM mode.
TRIGDT can be a qualified trigger, for example at Scope Pulse Triggering with trigger condition >T (e.g. > 10 ms), TRIGDT gives a trigger pulse if the input pulse meets the condition > 10 ms; TRIGDT can also be equal to the ALLTRIG signal.
- EXTTRIG is used to supply an odd/even field indication for video triggering to the D-ASIC. In normal trigger mode EXTTRIG can be used for triggering on a time slot.

Control signals for the trigger circuit are:

- HOLDOFF releases the trigger system. It goes low if the acquisition system is able to validate new triggers. HOLDOFF is supplied by the D-ASIC (pin B17).
- TRIGQUAL (or TRIGQUALJ in the old Main PCA) qualifies (conditions) the trigger to be supplied to the TRIGDT output. For example at video triggering on line n, the ALLTRIG triggers are counted down and only trigger n is passed to the TRIGDT output.

In the **OLD Main PCA** version, the TRIGQUALJ signal is supplied by the trigger qualifier extender circuit D3202-D3203, see circuit diagram Figure 9-5. The circuit qualifies triggers in the Trigger on Pulse Width mode for short pulses (< 300 ns). Without this circuit the system is unable to qualify short pulses due to (software) processing time.

If the ENSHPULS line is low, the TRIGQUAL signal is directly routed to the TRIGQUALJ output. If the ENSHPULS line is high, the circuit generates a new trigger qualifier signal TRIGQUALJ.

In the **NEW Main PCA** version the TRIGQUAL signal is directly supplied by the D-ASIC.

RAMP

The RSTRAMP and RAMPCLK control a dither signal generator. The output signal of this generator is used to improve the measuring accuracy.

Control (data/address buffer)

Via the buffered address/data bus (D2001, D2002) the D-ASIC can program the S-ASIC as required by the firmware.

The Read and Write control signals are derived from the ROMRD# and ROMWR# signals supplied by the D-ASIC.

CLOCK Signals

Crystal B2000 provides the synchronization clock signal for the TCM mode PLL oscillator (high sample rate).

The 20 MHz CLKJILL clock signal (pin 133) is used for readout of the samples, and is supplied by the D-ASIC (pin B18). During a high sample rate acquisition in the S-ASIC TCM mode, the INTRP line (S-ASIC pin 8 to D-ASIC pin A18) tells the D-ASIC to turn this clock off. This prevents the input signal samples from being influenced by the CLKJILL signal.

C-ASIC Control Linearization.

The C-ASIC Control Linearization circuit is used for control of the input circuits (see section 3.4.1) and the linearization of the Meter channel (see section 3.4.2).

3.4.4 S-ASIC supply

See circuit diagram Figure 9-5.

The S-ASIC supply section provides mutually decoupled supply voltages for the various circuits in the S-ASIC.

The supply voltages VIP5TOA (S-ASIC pin 17) and VIP5TOB (S-ASIC pin 95) control the offset voltage of the S-ASIC output signal in TCM mode (time base 2 μ s or faster, see preceding section "Sample&Memory"). They are derived from the REFADCT voltage, and from PWM controlled voltages supplied by the D-ASIC (pins C13 and D12). The voltages are set to such a value that the offset difference between TCM mode and WARS mode is zero. If the offset difference is not eliminated, AUTORANGE and OL (OverLoad) indication will not function correctly.

For the QUALIFIER EXTENDER circuit (D3202, D3203) see section 3.4.3, sub section "Trigger Path".

3.4.5 ADC's

See circuit diagram Figure 9-6.

The S-ASIC output voltages are supplied to ADC Channel A and ADC Channel B. The Meter/External Trigger channel uses the ADC Channel B. The ADC's sample the analog voltages, and convert them into 8-bit data bytes (D0-D7). The sample rate is 20 MHz. The sample clock SMPCLK is provided to pin 15 (new) or 24 (old). The output data are read and processed by the D-ASIC on the Digital Control section..

The reference voltage REFADCT (from S-ASIC pin 157) determines the input voltage swing that corresponds to an output data swing of 00000000 to 11111111 (D0-D7).

3.4.6 Digital Control

See circuit diagram Figure 9-7.

The Digital circuit is built up around the D-ASIC D3500. It provides the following functions:

- ADC data acquisition and processing for traces and numerical readings
- Trigger processing
- Microprocessor, Flash EPROM and RAM control
- Display control
- Keyboard control, ON/OFF control
- Miscellaneous functions, as PWM signal generation, SDA-SCL serial data control, probe detection, Slow ADC control, serial RS232 interface control, buzzer control, etc.

D-ASIC, RAM, ROM Supply

The D-ASIC is permanently powered by the +3V3GAR voltage supplied by the Power Circuit if at least the battery pack is present (+VD after filtering). The P-ASIC indicates the status of the +3V3GAR voltage via the VDDVAL line connected to D-ASIC pin N2. If +3V3GAR is >3V, VDDVAL is high, and the D-ASIC will start-up. As a result D-ASIC functions are operative regardless of the test tool ON/OFF status.

The RAM supply voltage +VDR2 and FlashROM supply voltage +VF are also derived from +3V3GAR.

Controlled switch off

The programmable logic device D3550 provides a controlled power down of the D-ASIC. In case of a non-controlled power down, a 6 mA D-ASIC supply current can flow after switching the test tool off. The normal D-ASIC supply current at power of is about 140 μ A.

Watchdog

In case a software hang-up arises, the watchdog circuit D3507 will reset the D-ASIC to re-start the software.

ADC data acquisition

The test tool software starts an acquisition cycle. The D-ASIC acquires the sample data from the ADC, and stores them internally in a Fast Acquisition Memory (FAM). A separate MIN/MAX FAM stores the samples with the highest and lowest value. From the FAMs the required ADC data are processed and output as LCD control data. Data can also be output via the UART to the optical RS232 interface.

Triggering

The D-ASIC controls and processes the trigger control signals HOLDOFF, TRIGDT, ALLTRIG, EXTTRIG and TRIGQUAL. See 3.4.4 sub section Trigger Path for a description of these signals.

Microprocessor, ROM and RAM control, mask ROM

For control purposes the D-ASIC includes a microprocessor.

The instrument software is loaded in Flash ROM located on the Flash/SRAM module A1 that is inserted into X3501.

The Flash/SRAM module also has RAM for temporary data storage.

The Flash/SRAM module for the OLD and the NEW Main PCA units are NOT equal.

Additional RAM is provided by D3502 and D3503 (D3503 for OLD Main PCA only). This RAM is used for, amongst others, the video information.

The D-ASIC has on-chip mask boot ROM. If no valid Flash ROM software is present when the test tool is turned on, the mask ROM software will become active. The test tool can be forced to stay in the mask ROM software by pressing and holding the ^ and > key, and then turning the test tool on. When active, the mask ROM software generates a HF triangular wave on measurement spot MS3603 (pinC5 of the D-ASIC, Row 1).

Display Control

The displayed screen consists of:

- information that is captured by the acquisition system, and is then processed and displayed (e.g. traces and numerical readings). This information is stored in RAM.
- information that is permanently stored in the test tool FlashROM memory, so called bitplanes (e.g. grids).

The D-ASIC supplies the LCD data and control signals to the LCD control circuit (section 3.4.7).

Keyboard Control, ON/OFF Control

The keys are arranged in a 6 rows x 6 columns matrix. The D-ASIC drives the rows, and senses the columns, see Figure 3-10. Initially the ROW lines are low, the column lines are high via a pull-up resistance in the D-ASIC. If a key is pressed a column line goes low, and causes an interrupt. Then the D-ASIC supplies pulses to the sequential ROW lines, and senses the column lines to detect which key is pressed.

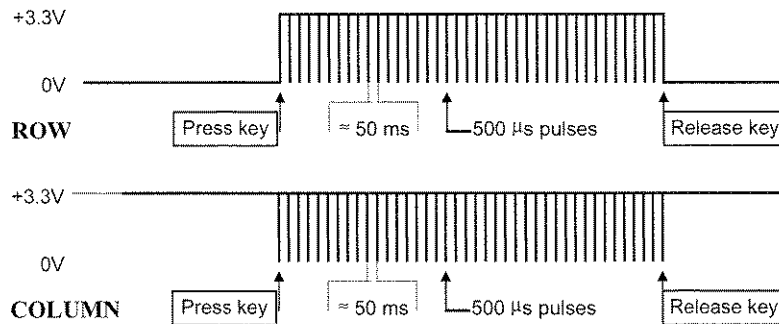

Figure 3-10. Keyboard Control Signals

The ON/OFF key is not included in the matrix. This key toggles a flip-flop in the D-ASIC via the ONKEY line (D-ASIC pin F4). As the D-ASIC is permanently powered by +3V3VGAR, the flip-flop can signal the test tool on/off status.

PWM Signals

The D-ASIC generates various pulse signals, by alternately connecting an output port to a reference voltage (REFPWM1 or REFPWM2) and ground (PWMA, PWMB pins 26-40). The duty cycle of the pulses is controlled by the software. By filtering the pulses in low pass filters (RC), software controlled DC voltages are generated. The voltages are used for various control purposes, see Table 3-3.

Table 3-3. D-ASIC PWM Signals

PWM signal	Function	Destination	Reference
TRGLV1AD, TRIGLV2AD TRGLV1BD, TRIGLV2BD	Trigger level control	S-ASIC	REFPWM1
OFFSETAD	Meter/Ext linearization	D2000	REFPWM1
BACKBRIG	Back light brightness control	Back light converter	REFPWM1
CONTR-D	Display contrast control	LCD unit	REFPWM1
DDTOFSA, DDTOF SB	S-ASIC offset control	S-ASIC	REFPWM1
SADCLEVD	Slow ADC comparator voltage	SLOW ADC	REFPWM2
CHARCURD	Battery charge current control	P-ASIC	REFPWM2

Serial Bus SDAT/SCLK - SDATEXT/SCLKEXT

The D-ASIC SDAT line (pin A2) is used to send control data to the C-ASIC's via the D2000 on the C-ASIC CONTROL LINEARIZATION circuit (Fig.9-4). The LINTAB signal (pin R5) controls D2000. The SCLK line (pin A3) transmits the 1.25 MHz synchronization clock .

The SDATEXT line pin P2 used to send control data to the Meter/External Trigger channel. The SCLKEXT line pin P1 transmits the synchronization clock.

D-ASIC Clocks

A 32 kHz oscillator runs if the 3V3GAR supply voltage is present, so if any power source is present (crystal B3501). The clock activates Power On/Off control circuit, and the real time clock (time and date).

A 40 MHz oscillator runs if the test tool is ON, and/or if the power adapter voltage is present (crystal B3502).

A 3.6864 MHz UART oscillator for the Serial RS232 communication runs if the 40 MHz oscillator runs (crystal B3500).

Buzzer

The buzzer is directly driven by a 4 kHz square wave from the D-ASIC (pin T4) via FET V4211. If the test tool is on, the +30VD supply from the Fly Back converter is present, and the buzzer sounds loudly. If the +30VD is not present, e.g. when the Mask (boot) software runs, the buzzer sounds weak.

3.4.7 LCD Control

See circuit diagram Figure 9-8.

The Liquid Crystal Display is built up of 320 columns of 240 pixels each. It is located on the LCD unit, which also includes the LCD drivers and the fluorescent back light lamp. The unit is connected to the main board via connector X3601.

The D-ASIC (Fig. 9-7) provides the LCD control signals to D3601 and D3602:

- LCDDATA0...7 + DATACLK: display data for the display column drivers
On the NEW Main PCA D3700 is installed to change the LCDDATA0-4 signal order. This order is different for a color LCD and b/w LCD.

- FRAME: during a frame pulse the LCD picture is refreshed
- LINECLK: sequentially transfers the data to the column driver outputs.
- DISPON: turns the display on or off
- M_ENAB: back plane modulation signal, see below.

The LCD supply circuit generates various voltage levels V0...V4 for the LCD. The various levels are supplied to the driver outputs, depending on the supplied data and the M(ultiplex) signal. The M signal (back plane modulation) is used by the LCD drivers to supply the various DC voltages in such an order, that the average voltage does not contain a DC component. A DC component in the LCD drive voltage may cause memory effects in the LCD.

The CONTRAST voltage controls the LCD contrast by changing the LCD Supply voltages. Is controlled by a D-ASIC PWM signal (pin A10, CONTR-D) to PWM filter R3311/C3310. The voltage REFPWM1 is used as bias voltage for the contrast adjustment amplifier N3600.

3.4.8 Power

See circuit diagram Figure 9-9.

Power Sources , Operating Modes

Figure 3-11 shows a simplified diagram of the power supply and battery charger circuit.

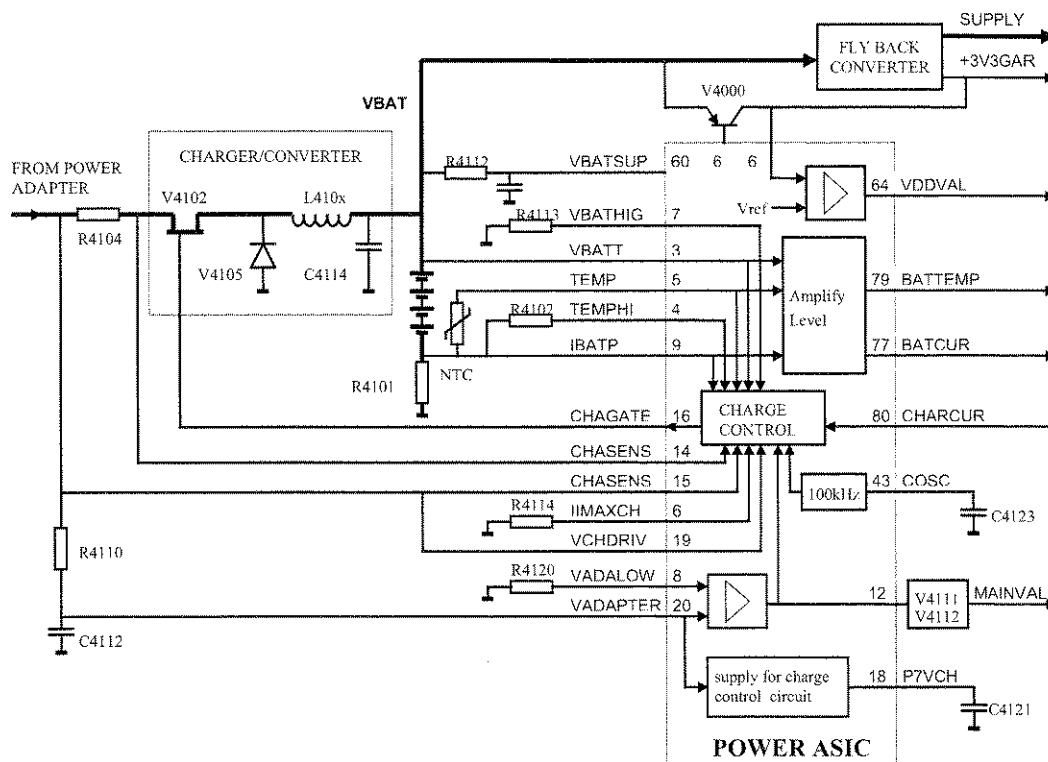

Figure 3-11. Power Supply Block Diagram

As described in Section 3.3 the test tool operating mode depends on the connected power source.

The voltage VBAT is supplied either by the power adapter via V4102/L410x, or by the battery pack. It powers a part of the P-ASIC via R4112 to pin 60 (VBATSUP). If the test tool is off, the Fly Back Converter is off, and VBAT powers the D-ASIC via transistor V4000 (+3V3GAR). This +3V3GAR voltage is controlled and sensed by the P-ASIC. If it is NOT OK (<3.05V), the output VDDVAL (pin 64) is low. The VDDVAL line is connected to the D-ASIC, and if the line is low, the D-ASIC is inactive: the test tool is in the **Idle mode**. A low VDDVAL line operates as a reset for the D-ASIC.

If VDDVAL is high (+3V3GAR > 3.05V), the D-ASIC becomes active, and the **Off mode** is entered. The D-ASIC monitors the P-ASIC output pin 12 via V4111-V4112 (MAINVAL), which indicates the presence of the power adapter voltage (high = present). The D-ASIC also monitors the test tool ON/OFF status (by pressing the ON/OFF key, a bit in the D-ASIC, indicating the test tool ON/OFF status is toggled). If neither a correct power adapter voltage is supplied (MAINVAL is low), nor the test tool is turned on, the **Off mode** will be maintained.

If a correct power adapter voltage is supplied (MAINVAL high), or if the test tool is turned on, the mask software starts up. The mask software checks if valid instrument software is present. If not, e.g. no instrument firmware is loaded, the mask software will keep running, and the test tool is not operative: the test tool is in the **Mask active** state. For test purposes the mask active mode can also be entered by pressing the ^ and > key when the test tool is turned on.

If valid software is present, one of the three modes **Operational**, **Operational & Charge** or **Charge** will become active. The Charger/Converter circuit is active in the Operational & Charge and in the Charge mode. The Fly back converter is active in the Operational and in the Operational & Charge mode.

Charger/Converter (See Figure 3-11.)

The power adapter powers the Charge Control circuit in the P-ASIC via an internal linear regulator. The power adapter voltage is applied to R4104. The Charger/Converter circuit controls the battery charge current. If a charged battery pack is installed, the nominal VBAT is 7.2 V (up to 9 V). If no battery pack is installed, VBAT is about 11 V. The voltage VBAT is supplied to the battery pack, to the P-ASIC, to the Fly Back Converter, and to transistor V4000. The FET control signal CHAGATE is a 100 kHz square wave voltage with a variable duty cycle, supplied by the P-ASIC Control circuit. The duty cycle determines the amount of energy loaded into L410x/C4114. By controlling the voltage VBAT, the battery charge current can be controlled. The various test tool circuits are supplied by the Fly Back Converter, and/or V4000.

Required power adapter voltage

The P-ASIC supplies a current to reference resistor R4120 (VADALOW pin 8). It compares the voltage on R4120 to the power adapter voltage VADAPTER on pin 20 (supplied via R4110, and attenuated in the P-ASIC). If the power adapter voltage is below 14 V, the P-ASIC output pin 12, and the line MAINVAL, are low. This signal on pin 12 is also supplied to the P-ASIC internal control circuit, which then makes the CHAGATE signal high. As a result FET V4102 becomes non-conductive, and the Charger/Converter is off.

Battery charge current

The actual charge current is sensed via resistor R4101, and filter R4103-C4102, on pin 9 of the P-ASIC (IBATP). The sense voltage is supplied to the control circuit in the P-ASIC. The required charge current information is supplied by the D-ASIC via the

CHARCUR line and filter R4121-C4122 to pin 80. A control loop in the control circuit adjusts the actual charge current to the required value.

Depending on the required charge current the filtered CHARCUR voltage range on pin 80 is:

- 0 V for a 1 A charge current.
- 1.75 V for a 0.35 A charge current
- 2.5 V for a 0.09 A charge current
- 2.6 V for a 0.06 A charge current
- 2.7 V for no charge current (0 A), for example if the battery temperature limit is exceeded ($>50\text{ }^{\circ}\text{C}$)
- > 3 Volt if the charger converter is off (V4102 permanently non-conductive). This happens for example if no BC190 is connected

The D-ASIC derives the required charge current value from the battery voltage VBAT. The D-ASIC measures this voltage via the Slow ADC (see 3.4.9. Slow ADC). The momentary value, and the temperature change as a function of time ($-dT/dt$), are used as control parameters. If the dT/dt exceeds $0.75\text{ }^{\circ}\text{C}$ per minute the battery is full.

Battery low indication

The battery empty indication on the LCD is given for a battery voltage $< 6.9\text{ V}$. If the voltage drops below 6.0 V , the test tool turns off.

Charging the battery

Battery Refresh

If a battery refresh is started the following actions are performed:

- the 1 A charge current is applied to the battery until it is full
- the charger is turned off, and as much as possible circuits are activated in order to discharge the battery in the shortest time. The initial discharge current is about 1 A.
- when the battery is discharged (battery voltage $< 6.4\text{V}$) the 1 A charge current is applied until the battery is full; then the 90 mA charge current is applied continuously.

Battery Charger BC190 connected, test tool off, battery completely discharged

- the 1 A charge current is applied until the battery is full (takes about 3.5 hrs)
- the 0.35 A charge current is applied for 2 hrs.
- the 90 mA charge current is applied continuously.

Battery Charger BC190 connected, test tool on

- the 60 mA charge current is applied continuously.

Battery temperature monitoring

The P-ASIC supplies a current to a NTC resistor in the battery pack (TEMP pin 5, battery connector pin 3). The P-ASIC conditions the voltage on pin 5 and supplies it to output pin 79 BATTEMP. The D-ASIC measures this voltage via the slow ADC. It uses the BATTEMP voltage for control purposes (set charge current).

Additionally the temperature is monitored by the P-ASIC. The P-ASIC supplies a current to reference resistor R4102 (TEMPHI pin 4), and compares the resulting TEMPHI voltage to the voltage on pin 5 (TEMP). If the battery temperature is too high,

the P-ASIC Control circuit will set the charge current to zero, in case the D-ASIC fails to do this.

During charging, the measured temperature change as a function of time ($-dT/dt$) is used to see if the battery is completely charged.

If the battery temperature monitoring system fails, a temperature switch in the battery pack interrupts the battery current if the temperature becomes higher than $70\text{ }^{\circ}\text{C}$

Maximum VBAT

The P-ASIC supplies a current to reference resistor R4113 (VBATHIGH pin 7). It compares the voltage on R4113 to the battery voltage VBAT on pin 3 (after being attenuated in the P-ASIC). The P-ASIC limits the voltage VBAT to 11 V via its internal Control circuit. This situation arises in case no battery or a defective battery (open) is present.

Battery Identity

The BATTIDENT line (pin 90) is connected to R4100 on the Power Circuit, and to a resistor in the battery pack. The voltage level indicates the installed battery type. If the battery is removed, the BATTIDENT line goes high.

Charger/Converter input current

The input current is sensed by R4104. The P-ASIC supplies a reference current to R4114. The P-ASIC compares the voltage drop on R4104 (CHASENSP-CHASENSN pin 14 and 15) to the voltage on R4114 (IMAXCHA pin 6). It limits the input current (e.g. when loading C4114 and C4000/C4001 just after connecting the power adapter) via its internal Control circuit.

CHAGATE control signal

The CHARGE CONTROL circuit in the P-ASIC supplies the CHAGATE control signal. The control circuit end stage supply voltage is VCHDRIVE. The CHAGATE high level makes V4102 non-conductive (“OFF”, $V_{gs} > 0$). The CHAGATE low level is limited to VCHDRIVE minus 13V, and makes V4102 conductive (“ON”, V_{gs} negative).

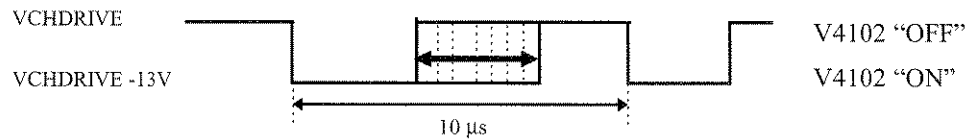

Figure 3-12. CHAGATE Control Voltage

+3V3GAR Voltage

When the test tool is not turned on, the Fly Back Converter does not run. In this situation, the +3V3GAR voltage for the D-ASIC, the FlashROM, and the RAM is supplied via transistor V4000. The voltage is controlled by the VGARDRV signal supplied by the P-ASIC (pin 69). The current sense voltage across R4000 is supplied to pin 70 (VGARCURR). The voltage +3V3GAR is sensed on pin 66 for regulation. The internal regulator in the P-ASIC regulates the +3V3GAR voltage, and limits the current.

Reference voltage REFPWM2

The +3.3 V voltage REFPWM2 is used as reference voltage for one of the PWM circuits in the D-ASIC. It is derived from reference diode V4114, as shown in Figure 3-13. REFPWM2 circuit.

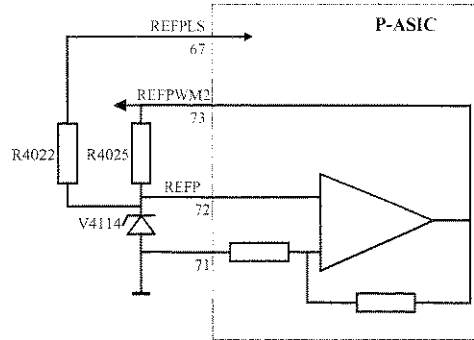

Figure 3-13. REFPWM2 circuit

Fly Back Converter

When the test tool is turned on, the D-ASIC makes the PWRON line (P-ASIC pin 62) high. Then the self oscillating Fly Back Converter becomes active. It is started up by the internal 100 kHz oscillator that is also used for the Charger/Converter circuit. First the FLYGATE signal (pin 49) turns FET V4001 on (see Figure 3-14), and an increasing current flows in the primary transformer winding to ground, via sense resistor R4003. If the voltage FLYSENSP across this resistor exceeds a certain value, the P-ASIC turns FET V4001 off. Then a decreasing current flows in the secondary windings to ground. If the windings are “empty” (all energy transferred), the voltage VCOIL sensed by the P-ASIC (pin 52) via R4001 is zero, and the FLYGATE signal will turn FET V4001 on again.

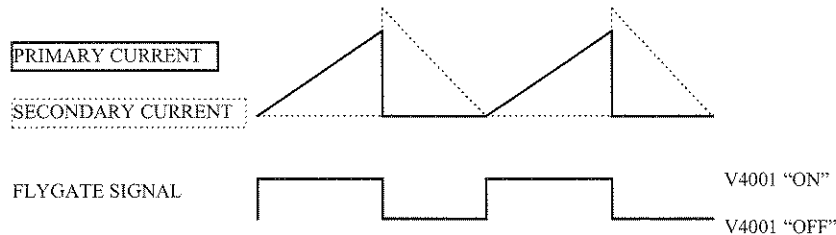

Figure 3-14. Fly-Back Converter Current and Control Voltage

The output voltage is regulated by feeding back a part of the +3V45 output voltage via attenuator R4011-R4012-R4013 to pin 54 (VSENS). This voltage is compared in the P-ASIC to a 1.23V reference voltage. Any deviation of the +3V45 voltage from the required 3.45V changes the current level at which current FET V4001 will be switched off. If the output voltage increases, the current level at which V4001 is switched off will become lower, and less energy is transferred to the secondary winding. As a result the output voltage will become lower.

An current source in the P-ASIC supplies a current to R4020. The resulting voltage is a reference for the maximum allowable primary current (IMAXFLY). The voltage across the sense resistor (FLYSENSP) is compared in the P-ASIC to the IMAXFLY voltage. If the current exceeds the set limit, FET V4001 will be turned off.

Another internal current source supplies a current to R4014. This resulting voltage is a reference for the maximum allowable output voltage (VOUTH1). The secondary output voltage -1V8 is supplied to the P-ASIC, and then compared to the VOUTH1 voltage. If the voltage -1V8 exceeds the set limit, FET V4001 will be turned off.

The FREQPS signal drives the P-ASIC output stage that supplies the FET drive FLYGATE signal. It is also supplied to the D-ASIC, in order to detect if the Fly Back converter is running within specified frequency limits (used in factory test only).

3.4.9 Slow ADC, RS232 Serial Interface, LCD Backlight

See circuit diagram Figure 9-10.

Slow ADC

With the Slow ADC the D-ASIC can measure various signals for control and test purposes:

D4300 pin 12-15: battery current (BATCUR), battery voltage (BATVOLT), battery temperature (BATTEMP), battery identity (BATIDENT).

D4300 pin 1: REFADCT can be measured for calibration and test purposes.

D4300 pin 5 : the internal test tool temperature is monitored by measuring the voltage on the PTC silicon sensor V4205. The result is used for control purposes, for example to control the LCD contrast.

D4300 pin 4 : sense the MAIN PCA version, depending on values of R4304 and 4305

D4300 pin 2 : backlight lamp current.

De-multiplexer D4300 supplies one of its input signals to comparator N4300 (pin 4). The D-ASIC supplies the D4300 control signals SELMUX0-2. The Slow ADC works according to the successive approximation principle. The D-ASIC changes the voltage level on pin 3 of the comparator (SADCLEV) step wise, by changing the duty cycle of the PWM signal SADCLEVD. The comparator output SLOWADC is monitored by the D-ASIC, in order to detect if the previous input voltage step caused the comparator output to switch. By decreasing the voltage steps, the voltage level can be approximated within the smallest possible step of the SADCLEV voltage. From its set SADCLEVD duty cycle, the D-ASIC determines the voltage level of the selected input.

Optical RS232 interface

Transmit, TXD1

The optical interface output LED H3400 is directly connected to the TXD1 line controlled by the D-ASIC (pin L1).

Receive, RXD1

The RXD1 line is sensed by the D-ASIC (pin L2)

If no light is received light sensitive diode H3401 does not conduct. Opamp N3401B pin 2 is at ground level, pin 3 is approximately +0.25V, so the RXD1 line is high.

If light is received H3401 will conduct. The voltage at the cathode of the upper diode in V3401 is directly supplied to opamp N3401B pin 2. The voltage at the lower diode in V3401 is divided by R3403/R3404 and then supplied to N3401B pin 3. As a result the RXD1 line is low.

The +3V3SADC supply voltage is present if the test tool is turned on, or if the Power Adapter is connected (or both). So if the Power Adapter is present limited serial communication is possible, even when the test tool is off. In this way the test tool can be turned on by means of a command sent via the serial interface.

Backlight Converter

The LCD back light is provided by a Ø2.4 mm fluorescent lamp in LCD unit. The back light converter generates the 300-400 V_{pp} supply voltage. The circuit consists of:

- A pulse width modulated (PWM) buck regulator to generate a variable, regulated voltage (V4200, V4202, L4200, C4210).

- A zero voltage switched (ZVS) resonant push-pull converter to transform the variable, regulated voltage into a high voltage AC output (V4201, T4200).

The PWM buck regulator consists of FET V4200, V4202, L4200, C4202, and a control circuit in N4200. FET V4200 is turned on and off by a square wave voltage on the COUT output of N4200 (pin 14). By changing the duty cycle of this signal, the output on C4210 provides a variable, regulated voltage. The turn on edge of the COUT signal is synchronized with each zero detect.

Outputs AOUT and BOUT of N4200 provide complementary drive signals for the push-pull dual FET V4201. If V4201B conducts, the circuit consisting of the primary winding of transformer T4200 and C4211, will start oscillating at its resonance frequency. After half a cycle, a zero voltage is detected on pin 9 (ZO) of N4200, V4201B will be turned off, and V4201A is turned on. This process goes on each time a zero is detected. The secondary transformer current is sensed by R4201, and fed back to N4200 pin 7 and pin 4 for regulation of the PWM buck regulator output voltage.

If the TLON signal, controlled by the D-ASIC, goes high the backlight is turned on (N4200 pin 13 ENABLE is high).

Feedback of the lamp current is established by sensing the voltage across R4202 on N4200 pin 7. If the voltage drops below approximately 1.5V an “open lamp” is detected and the converter is turned off. Soft start input N4200 pin 5 and R4207/C4201 allow time for the lamp to strike and conduct the programmed level of current before enabling the “open lamp” detection.

The BACKBRIG signal supplied by the D-ASIC provides a pulse width modulated (variable duty cycle) square wave. By changing the duty cycle of this signal, the average on-resistance of V4210 can be changed. This will change the secondary current, and thus the back light intensity. The voltage on the “cold” side of the lamp is limited by V4204 and V4203. This limits the emission of electrical interference.

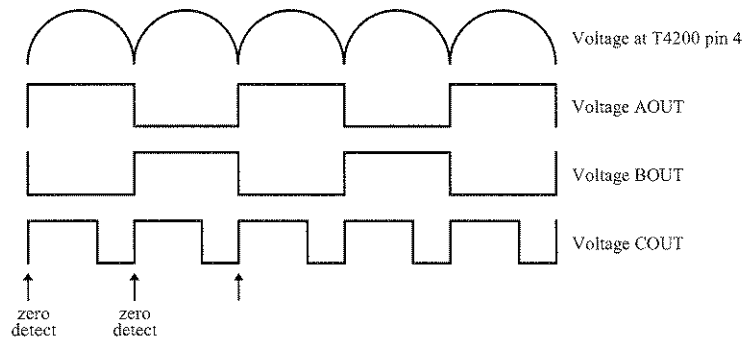

Figure 3-15. Back Light Converter Voltages



Chapter 4

Performance Verification

Title	Page
4.1 Introduction	4-3
4.2 Equipment Required For Verification	4-3
4.3 General Instructions	4-3
4.4 Operating Instructions	4-4
4.4.1 Resetting the test tool	4-4
4.4.2 Navigating through menu's	4-4
4.4.3 Creating Test Tool Setup1	4-5
4.5 Display and Backlight Test	4-5
4.6 Scope Input A&B Tests	4-7
4.6.1 Input A&B Vertical Accuracy Test	4-7
4.6.2 Input A&B DC Voltage Accuracy Test	4-9
4.6.3 Input A&B AC Voltage Accuracy Test (LF)	4-11
4.6.4 Input A & B AC Coupled Lower Frequency Test	4-12
4.6.5 Input A and B Peak Measurements Test	4-13
4.6.6 Input A&B Frequency Measurement Accuracy Test	4-14
4.6.7 Input A&B Phase Measurements Test	4-15
4.6.8 Time Base Test	4-16
4.6.9 Input A Trigger Sensitivity Test	4-17
4.6.10 Input A AC Voltage Accuracy (HF) & Bandwidth Test	4-19
4.6.11 Input B Trigger Sensitivity Test	4-20
4.6.12 Input B AC Voltage Accuracy (HF) & Bandwidth Test	4-21
4.6.13 Video test using the Video Pattern Generator	4-22
4.6.14 Video test using SC600 Scope Calibration Option	4-24
4.7 External Trigger Level Test	4-27
4.8 Meter (DMM) Tests	4-28
4.8.1 Meter DC Voltage Accuracy Test	4-28
4.8.2 Meter AC Voltage Accuracy & Frequency Response Test	4-29
4.8.3 Continuity Function Test	4-30
4.8.4 Diode Test Function Test	4-30
4.8.5 Ohms Measurements Test	4-30
4.9 Probe Calibration Generator Test	4-32



4.1 Introduction

Warning

Procedures in this chapter should be performed by qualified service personnel only. To avoid electrical shock, do not perform any servicing unless you are qualified to do so.

The Fluke 192B/196B-C/199B-C ScopeMeter® test tool (referred to as test tool) should be calibrated and in operating condition when you receive it.

The following performance tests are provided to ensure that the test tool is in a proper operating condition. If the test tool fails any of the performance tests, calibration adjustment (see Chapter 5) and/or repair (see Chapter 7) is necessary.

The Performance Verification Procedure is based on the specifications, listed in Chapter 2 of this Service Manual. The values given here are valid for ambient temperatures between 18 °C and 28 °C.

The Performance Verification Procedure is a quick way to check most of the test tool's specifications. Because of the highly integrated design of the test tool, it is not always necessary to check all features separately.

4.2 Equipment Required For Verification

The primary source instrument used in the verification procedures is the Fluke 5500A. If a 5500A is not available, you can substitute another calibrator as long as it meets the minimum test requirements.

- Fluke 5500A Multi Product Calibrator, including SC300 or SC600 Oscilloscope Calibration Option.
- Stackable Test Leads (4x), supplied with the 5500A.
- 50Ω Coax Cables (2x), Fluke PM9091 (1.5m) or PM9092 (0.5m).
- Male BNC to Dual Female BNC adapter (1x), Fluke PM9093/001
- 50Ω feed through termination, Fluke PM9585.
- Dual Banana Plug to Female BNC Adapter (1x), Fluke PM9081/001.
- Dual Banana Jack to Male BNC Adapter (1x), Fluke PM9082/001.
- TV Signal Generator, Philips PM5418, NOT required if SC600 Oscilloscope Calibration Option is used.
- 75Ω Coax cable (1x), Fluke PM9075.
- 75Ω Feed through termination (1x), ITT-Pomona model 4119-75.

4.3 General Instructions





Follow these general instructions for all tests:

- For all tests, power the test tool with the BC190 power adapter/battery charger. The battery pack must be installed.
- Allow the 5500A to satisfy its specified warm-up period.
- For each test point, wait for the 5500A to settle.
- Allow the test tool a minimum of 30 minutes to warm up.
- One division on the LCD consists of 25 pixels (1 pixel = 0.04 division).

4.4 Operating Instructions

4.4.1 Resetting the test tool





Proceed as follows to reset the test tool:

- Press  to turn the test tool off.
- Press and hold .
- Press and release  to turn the test tool on.
- Wait until the test tool has **beeped twice**, and then release . When the test tool has beeped twice, the RESET was successful.

4.4.2 Navigating through menu's

During verification you must open menus, and to choose items from the menu.

Proceed as follows to make choices in a menu :

- Reset the test tool
- Open a menu, for example press , then press  (READING 1). The menu as showed in Figure 4-1 will be opened.
Active functions are marked by , inactive functions by .
If more than one menu groups are available, they will be separated by a vertical line.
The menu you opened indicates that **READING 1** (that is the upper left reading) shows the result of a V ac+dc measurement (V ac+dc) on Input A (on A).
- Press  or  to highlight the function to be selected.
- Press  (ENTER) to confirm the selection.
The active function in the next menu group will be highlighted now. If the confirmation was made in the last (most right) menu group, the menu will be closed.

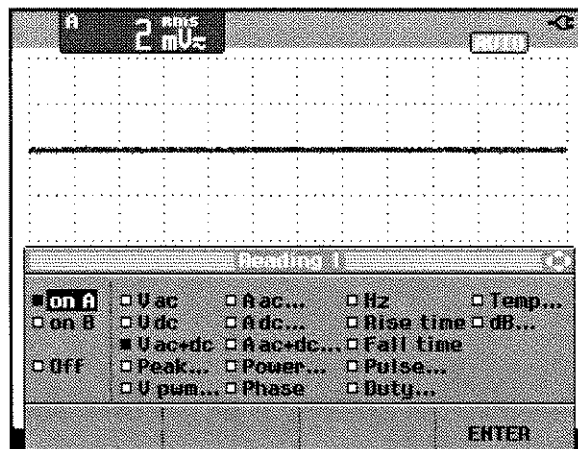



















Figure 4-1. Menu item selection

ws-read1.bmp

4.4.3 Creating Test Tool Setup1



Before starting the verification procedure you must define a standard test tool setup, called SETUP 1. During verification you will be asked to recall this setup. This defines the initial test tool setup for each verification.

Proceed as follows to create SETUP1:



1. Reset the test tool. Input A is ON, Input B is OFF now.
2. Press . The inverse text indicates the actual settings.
3. Press  (toggle key) to select **INPUT B ON**. The Input B trace will become visible.
4. Press  to change the **PROBE B** setting.
5. Select **Probe Type: ■ Voltage | Attenuation: ■ 1:1**.
6. Press . The inverse text indicates the actual settings.
7. Press  to change the **PROBE A** setting.
8. Select **Probe Type: ■ Voltage | Attenuation: ■ 1:1**.
9. Press .
10. Press  to select **READINGS ON**
11. Press  **READING 1**, and select **■ on A | ■ V dc**
12. Press  **READING 2**, and select **■ on B | ■ V dc**
13. Press  **WAVEFORM OPTIONS** and select
Glitch Detect: ■ Off | Average: ■ Off | Waveform: ■ NORMAL
14. Press  to select MANUAL ranging (**MANUAL** in upper left of screen)
15. Press .
16. Press  **SAVE...**
17. Using  and  select **SCREEN+SETUP □ 1 (or ■ 1)**.
18. Press  **SAVE** to save the actual test tool settings in setup memory 1.
19. Press  to leave the HOLD mode.

4.5 Display and Backlight Test

Proceed as follows to test the display and the backlight:

1. Press  to turn the test tool on.
2. Remove the BC190 adapter power, and verify that the backlight is dimmed.
3. Apply the BC190 adapter power and verify that the backlight brightness increases.
4. Press and hold , then press and release  (CLEAR MENU)

The test tool shows the calibration menu in the bottom of the display.

- Do not press  now! If you did, turn the test tool off and on, and start at 4.
 - Pressing  will toggle the menu on-off.
5. Press  **PREVIOUS** three times.
The test tool shows **Contrast (CL 0100)**:

6. Press  **CALIBRATE** .

The test tool shows a dark display; the test pattern as shown in Figure 4-2 may be not visible or hardly visible.

Observe the display closely, and verify that the display shows no abnormalities, as for example very light pixels or lines.

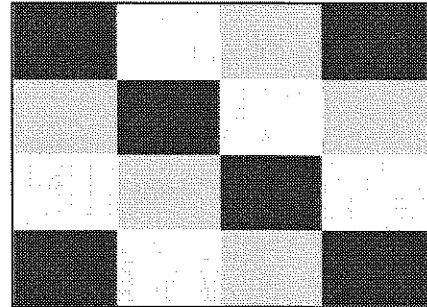







Figure 4-2. Display Pixel Test Pattern

7. Press  .
The test pattern is removed; the test tool shows **Contrast (CL 0100)**:
8. Press  again to do the next step **Contrast (CL 0110)**:
9. Press  **CALIBRATE**
The test tool shows the display test pattern shown in Figure 4-2, at default contrast. Observe the display closely, and verify that the display shows no abnormalities. Also verify that the contrast of the upper left and upper right square of the test pattern is equal.
10. Press  .
The test pattern is removed; the test tool shows **Contrast (CL 0110)**:
11. Press  again to do the next step **Contrast (CL 0120)**:
12. Press  **CALIBRATE**
The test tool shows a light display; the test pattern as shown in Figure 4-2 may not be visible or hardly visible. Observe the display closely, and verify that the display shows no abnormalities.
13. Turn the test tool OFF and ON to exit the calibration menu and to return to the normal operating mode.

If the maximum, minimum, or default display contrast is not OK, then you can set these items without performing a complete calibration adjustment; refer to Section 5 for detailed information.

4.6 Scope Input A&B Tests

4.6.1 Input A&B Vertical Accuracy Test

WARNING

Dangerous voltages will be present on the calibration source and connecting cables during the following steps. Ensure that the calibrator is in standby mode before making any connection between the calibrator and the test tool.

Proceed as follows:

1. Connect the test tool to the 5500A as shown in Figure 4-3.

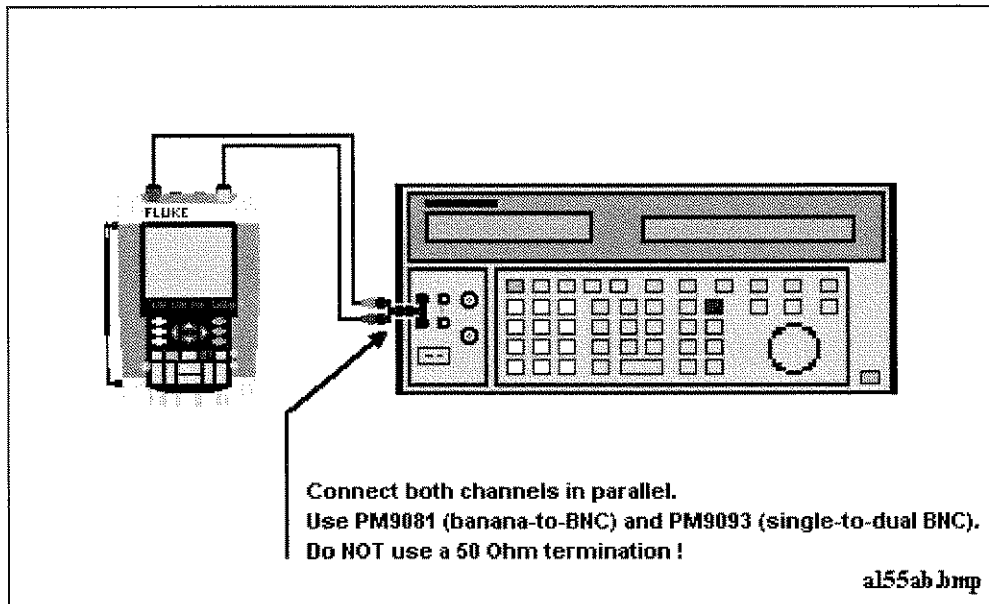















Figure 4-3. Test Tool Input A&B to 5500 Normal Output

2. Select the following test tool setup:
 - Recall the created SETUP 1 (see section 4.4.3): press ,  RECALL , select **SCREEN+SETUP**  **1** , press  RECALL SETUP .
 - Press  , press  INPUT A OPTIONS... , and select  Polarity Normal | Bandwidth:  10 kHz (HF reject)
 - Press  , press  INPUT B OPTIONS... , and select  Polarity Normal | Bandwidth:  10 kHz (HF reject)
 - Press  to clear the softkey menu, and to see the full screen.

Note:

The 10 kHz bandwidth limiter rejects calibrator noise. It does not affect the gain accuracy at a 50 Hz input signal









3. Using  change the time base to select manual time base ranging, and lock the time base on 10 ms/div.
4. Using  and  move the Input A ground level (indicated by the zero icon  in the left margin) to the center grid line.
5. Using  and  move the Input B ground level (indicated by the zero icon  in the left margin) to the grid line one division below the center grid line.
6. Using  and  set the Input A and B sensitivity range to the first test point in Table 4-1.
7. Set the 5500A to source the appropriate initial ac voltage.
8. Adjust the 5500A output voltage until the displayed Input A trace amplitude is 6 divisions.
9. Observe the 5500A output voltage and check to see if it is within the range shown under the appropriate column.
10. Adjust the 5500A output voltage until the displayed Input B trace amplitude is 6 divisions.
11. Observe the 5500A output voltage and check to see if it is within the range shown under the appropriate column.
12. Continue through the test points.
13. When you are finished, set the 5500A to 0 (zero) Volt, and to Standby.

Table 4-1. Vertical Accuracy Verification Points

Range	Initial 5500A Setting, V ac, sine, 50 Hz	Allowable 5500A output for trace amplitude of 6 divisions
2 mV/div ¹⁾	4.243 mV	4.081 to 4.405
5 mV/div	10.606 mV	10.247 to 10.966
10 mV/div	21.213 mV	20.495 to 21.932
20 mV/div	42.426 mV	40.990 to 43.862
50 mV/div	106.06 mV	102.475 to 109.657
100 mV/div	212.13 mV	204.950 to 219.314
200 mV/div	424.26 mV	409.90 to 438.62
500 mV/div	1.0607 V	1.02475 to 1.09657
1 V/div	2.1213 V	2.04950 to 2.19314
2 V/div	4.2426 V	4.0990 to 4.3862
5 V/div	10.606 V	10.2475 to 10.9657
10 V/div	21.213 V	20.4950 to 21.9314
20 V/div	42.426 V	40.990 to 43.862
50 V/div	106.06 V	102.47 to 109.65
100 V/div	212.13 V	204.95 to 219.31

¹⁾ C versions only

Note

The vertical accuracy test can also be done with dc voltage. This method is advised for automatic verification using the Fluke Met/Cal Metrology Software. For each sensitivity range you must proceed as follows:

1. Apply a +3 divisions voltage, and adjust the voltage until the trace is at +3 divisions. Write down the applied voltage $V1$
2. Apply a -3 divisions voltage, and adjust the voltage until the trace is at -3 divisions. Write down the applied voltage $V2$
3. Verify that $V1 - V2 = 6 \times \text{range} \pm (1.5\% + 0.04 \times \text{range})$.:
Example for range 10 mV/div.:
The allowed $V1 - V2 = 60 \text{ mV} \pm (0.015 \times 60 + 0.04 \times 10)$
 $= 60 \text{ mV} \pm (0.9 + 0.4) = 60 \text{ mV} \pm 1.3 \text{ mV}$

4.6.2 Input A&B DC Voltage Accuracy Test

WARNING

Dangerous voltages will be present on the calibration source and connecting cables during the following steps. Ensure that the calibrator is in standby mode before making any connection between the calibrator and the test tool.

Proceed as follows to verify the automatic dc voltage scope measurement:



















1. Connect the test tool to the 5500A as for the previous test (see Figure 4-3).
2. Select the following test tool setup:
 - Recall the created SETUP 1 (see section 4.4.3): press  ,  **RECALL** , select **SCREEN+SETUP**  **1** , press  **RECALL SETUP** .
 - Press  , then press  **INPUT A OPTIONS ...**
 - Select **Polarity:  Normal | Bandwidth:  10 kHz (HF Reject)**
 - Press  , then press  **INPUT B OPTIONS ...**
 - Select **Polarity:  Normal | Bandwidth:  10 kHz (HF Reject)**
 - Press  to clear the softkey menu, and to see the full 8 divisions screen.
3. Using  change the time base to select manual time base ranging, and lock the time base on 10 ms/div.
4. Using  and  move the Input A and B ground level (zero icon  in the left margin) approximately to the center grid line.
5. Using  and  select manual vertical ranging and set the Input A and B sensitivity range to the first test point in Table 4-2. The sensitivity ranges are indicated in the left and right lower display edge.
6. Set the 5500A to source the appropriate dc voltage.
7. Observe the readings (**1.A** and **2.B**) and check to see if it is within the range shown under the appropriate column. Due to calibrator noise, occasionally OL (overload) can be shown.
8. Continue through the test points.
9. When you are finished, set the 5500A to 0 (zero) Volt, and to Standby.

Table 4-2. Volts DC Measurement Verification Points

Range	5500A output V dc	Input A&B Reading
2 mV/div ¹⁾	+6.0 mV	+4.9 to +7.1
	-6.0 mV	-4.9 to -7.1
5 mV/div	+15.0 mV	+14.3 to +15.7
	-15.0 mV	-14.3 to -15.7
10 mV/div	+30.0 mV	+29.1 to +30.9
	-30.0 mV	-29.1 to -30.9
20 mV/div	+60.0 mV	+58.6 to +61.4
	-60.0 mV	-58.6 to -61.4
50 mV/div	+150 mV	+143 to +157
	-150 mV	-143 to -157
100 mV/div	+300 mV	+291 to +309
	-300 mV	-291 to -309
200 mV/div	+600 mV	+586 to +614
	-600 mV	-586 to -614
500 mV/div	+1.50 V	+1.43 to +1.57
	-1.50 V	-1.43 to -1.57
1 V/div	+3.00 V	+2.91 to +3.09
	-3.00 V	-2.91 to -3.09
2 V/div	+6.00 V	+5.86 to +6.14
	-6.00 V	-5.86 to -6.14
5 V/div	+15.0 V	+14.3 to +15.7
	-15.0 V	-14.3 to -15.7
10 V/div	+30.0 V	+29.1 to +30.9
	-30.0 V	-29.1 to -30.9
20 V/div	+60.0 V	+58.6 to +61.4
	-60.0 V	-58.6 to -61.4
50 V/div	+150 V	+143 to +157
	-150 V	-143 to -157
100 V/div	+300 V	+291 to +309
	-300 V	-291 to -309

¹⁾ C versions only.

4.6.3 Input A&B AC Voltage Accuracy Test (LF)

This procedure tests the Volts ac accuracy with dc coupled inputs up to 50 kHz. The high frequencies are tested in sections 4.6.10 and 4.6.12.

Warning

Dangerous voltages will be present on the calibration source and connecting cables during the following steps. Ensure that the calibrator is in standby mode before making any connection between the calibrator and the test tool.

Proceed as follows to test the Input A and B automatic scope ac Voltage measurement accuracy:



























1. Connect the test tool to the 5500A as for the previous test (see Figure 4-3).
2. Select the following test tool setup:
 - Recall the created SETUP 1 (see section 4.4.3): press ,  **RECALL** , select **SCREEN+SETUP**  **1** , press  **RECALL SETUP** .
 - Press , then press  **INPUT A OPTIONS ...**
 - Select **Polarity:**  **Normal** | **Bandwidth:**  **20 MHz**
 - Press , then press  **INPUT B OPTIONS ...**
 - Select **Polarity:**  **Normal** | **Bandwidth:**  **20 MHz**
 - Press  **SCOPE**
 - Press  **READING 1** , and select  **on A** |  **V ac**.
 - Press  **READING 2** , and select  **on B** |  **V ac**.
 - Press  to clear the softkey menu, and to see the full screen.
3. Using  change the time base to select manual time base ranging. Lock the time base on 20 μ s/div for the 20 kHz signals, and on 10 ms/div for the 60 Hz signal.
4. Using  and  move the Input A and B ground level (indicated by the zero icon  in the left margin) to the center grid line.
5. Using  and  select manual vertical ranging, and set the Input A and B sensitivity range to the first test point in Table 4-3. The sensitivity ranges are indicated in the left and right lower display edge in gray.
6. Set the 5500A to source the appropriate ac voltage.
7. Observe the readings (**1.A** and **2.B**) and check to see if it is within the range shown under the appropriate column.
8. Continue through the test points.
9. When you are finished, set the 5500A to 0 (zero) Volt, and to Standby.















Table 4-3. Volts AC Measurement Verification Points

Range	5500A output		Input A&B Reading
	V ac	Frequency	
2 mV/div ¹⁾ (Select 10 ms/div) Set input A&B Bandwidth 10 kHz to prevent OL due to calibrator noise: see step 2.	4 mV	60 Hz	3.0 mV to 5.0 mV
5 mV/div (Select 20 μs/div). Set input A&B Bandwidth 20 MHz	10 mV	20 kHz	8.3 mV to 11.7 mV
10 mV/div	20 mV	20 kHz	18.0 mV to 22.0 mV
20 mV/div	40 mV	20 kHz	37.5 mV to 42.5 mV
50 mV/div	100 mV	20 kHz	96.0 mV to 104.0 mV
100 mV/div	200 mV	20 kHz	180 mV to 220 mV
200 mV/div	400 mV	20 kHz	375 mV to 425 mV
500 mV/div (Select 10 ms/div)	900 mV	60 Hz	877 mV to 923 mV
500 mV/div (Select 20 μs/div)	900 mV	20 kHz	863 mV to 937 mV
1 V/div	2 V	20 kHz	1.80 V to 2.20 V
2 V/div	4 V	20 kHz	3.75 V to 4.25 V
5 V/div	9 V	20 kHz	8.63 V to 9.37 V
10 V/div	20 V	20 kHz	18.0 V to 22.0 V
20 V/div	40 V	20 kHz	37.5 V to 42.5 V
50 V/div	90 V	20 kHz	86.3 V to 93.7 V
100 V/div	200 V	20 kHz	180 V to 220 V

¹⁾ C versions only

4.6.4 Input A & B AC Coupled Lower Frequency Test

Proceed as follows to test the ac coupled input low frequency accuracy:

1. Connect the test tool to the 5500A as for the previous test (see Figure 4-3).
2. Select the following test tool setup:
 - Recall the created SETUP 1 (see section 4.4.3): press ,  **RECALL**, select **SCREEN+SETUP**  **1**, press  **RECALL SETUP**.
 - Press 
 - Press  **READING 1**, and select  on **A** |  **V ac**.
 - Press  **READING 2**, and select  on **B** |  **V ac**.
 - Press , then using  select **COUPLING AC**
 - Press , then using  select **COUPLING AC**







- Press  to clear the softkey menu, and to see the full screen.
- 3. Using  change the time base to select manual time base ranging, and lock the time base on 50 ms/div.
- 4. Using  and  move the Input A and B ground level (indicated by the zero icon  in the left margin) to the center grid line.
- 5. Using  and  select manual vertical ranging, and set the Input A and B sensitivity range to 500 mV.
- 6. Set the 5500A to source the appropriate ac voltage and frequency, according to Table 4-4.
- 7. Observe the readings (1.A and 2.B) and check to see if it is within the range shown under the appropriate column.
- 8. Continue through the test points.
- 9. When you are finished, set the 5500A to 0 (zero) Volt, and to Standby.

Table 4-4. Input A&B AC Input Coupling Verification Points















5500A output, V rms	5500A Frequency	Reading 1.A and 1.B
900 mV	60 Hz	873 mV to 927 mV
900 mV	5 Hz	>630 mV

4.6.5 Input A and B Peak Measurements Test

WARNING

Dangerous voltages will be present on the calibration source and connecting cables during the following steps. Ensure that the calibrator is in standby mode before making any connection between the calibrator and the test tool.

Proceed as follows to test the Peak measurement accuracy:

1. Connect the test tool to the 5500A as for the previous test (see Figure 4-3).
2. Select the following test tool setup:
 - Recall the created SETUP 1 (see section 4.4.3): press ,  **RECALL** , select **SCREEN+SETUP**  **1** , press  **RECALL SETUP** .
 - Press  **SCOPE**
 - Press  **READING 1** , and select  **on A** |  **Peak**. Select  **Peak-Peak** from the **Peak** menu.
 - Press  **READING 2** , and select  **on B** |  **Peak**. Select  **Peak-Peak** from the **Peak** menu.
 - Press  to clear the softkey menu, and to see the full screen.
3. Using  change the time base to select manual time base ranging, and lock the time base on 1 ms/div.





4. Using  and  move the Input A and B ground level (indicated by the zero icon  in the left margin) to the center grid line.
5. Using  and  select manual vertical ranging, and set the Input A and B sensitivity range to 100 mV.
6. Set the 5500A to source the appropriate ac voltage and frequency, according to Table 4-5.
7. Observe the readings (**1.A** and **2.B**) and check to see if it is within the range shown under the appropriate column.
8. Continue through the test points.
9. When you are finished, set the 5500A to 0 (zero) Volt, and to Standby.

Table 4-5. Volts Peak Measurement Verification Points

5500A output, Vrms (sine)	5500A Frequency	Reading A-B
212.13 mV (0.6 V pp)	1 kHz	0.56 to 0.64

4.6.6 Input A&B Frequency Measurement Accuracy Test

Proceed as follows to test the frequency measurement accuracy:

1. Connect the test tool to the 5500A as shown in Figure 4-4. Do NOT use 50 Ω terminations!

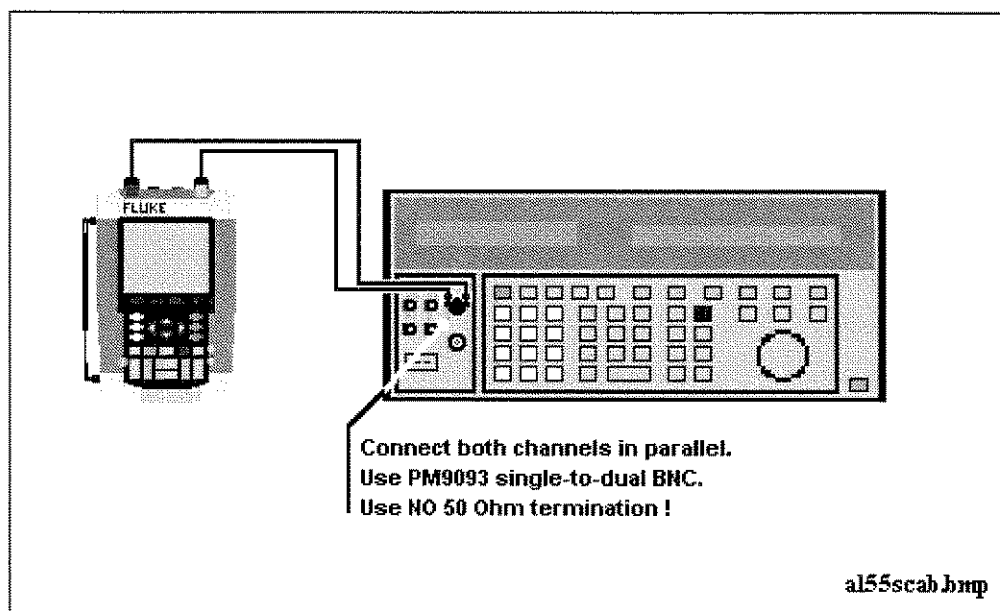







Figure 4-4. 5500 Scope Output to Test Tool Input A&B

2. Select the following test tool setup:
 - Recall the created SETUP 1 (see section 4.4.3): press ,  **RECALL**, select **SCREEN+SETUP**  **1**, press  **RECALL SETUP**.
 - Press  **SCOPE**





- Press  **READING 1** , and select **on A | Hz**.
 - Press  **READING 2** , and select **on B | Hz**.
3. Using  and  select range 100 mV/div for A and B.
 4. Using  select the required time base setting.
 5. Set the 5500A to source a sine wave according to the first test point in Table 4-6. As no 50Ω termination is applied, the 5500 leveled sine wave output amplitude will be twice the set value.
 6. Observe the readings (**1.A** and **2.B**) and check to see if it is within the range shown under the appropriate column.
 7. Continue through the test points.
 8. When you are finished, set the 5500A to 0 (zero) Volt, and to Standby.

Table 4-6. Input A&B Frequency Measurement Accuracy Test









Model	Time base	5500A-SC... MODE	Voltage	Frequency	Input A&B Reading
all	20 ms/div	wavegen, sine	600 mVpp	16 Hz	15.90 to 16.10
192B	20 ns/div	levsine	300 mVpp	60 MHz	59.68 to 60.32
196B-C	20 ns/div	levsine	300 mVpp	100 MHz	99.3 to 100.7
199B-C	20 ns/div	levsine	300 mVpp	200 MHz	198.8 to 201.2

Note

Duty Cycle and Pulse Width measurements are based on the same principles as Frequency measurements. Therefore the Duty Cycle and Pulse Width measurement function will not be verified separately.

4.6.7 Input A&B Phase Measurements Test

Proceed as follows to test the phase measurement accuracy:

1. Connect the test tool to the 5500A as for the previous test (see Figure 4-4).
2. Select the following test tool setup:
 - Recall the created SETUP 1 (see section 4.4.3): press  ,  **RECALL** , select **SCREEN+SETUP ■ 1** , press  **RECALL SETUP** .
 - Press 
 - Press  **READING 1** , and select **on A | Phase**.
 - Press  **READING 2** , and select **on B | Phase**.
3. Using  and  select range 100 mV/div for A and B.
4. Using  select the required time base setting.
5. Set the 5500A to source a sine wave according to the first test point in Table 4-6. As no 50Ω termination is applied, the 5500 leveled sine wave output amplitude will be twice the set value.

6. Observe the reading **1.A** and **2.B** and check to see if they are not outside the range shown under the appropriate column.
7. Continue through the test points.
8. When you are finished, set the 5500A to 0 (zero) Volt, and to Standby.

Table 4-7. Phase Measurement Verification Points

Time base	5500A-SC... MODE	Frequency	Voltage	Input A&B Reading ...Deg
20 ms/div	wavegen, sine, 1 MΩ	10 Hz	600 mVpp	-2 to +2
200 ns/div	levsine	1 MHz	300 mVpp	-2 to +2
20 ns/div	levsine	10 MHz	300 mVpp	-3 to +3

4.6.8 Time Base Test

Proceed as follows to test the time base accuracy:

1. Connect the test tool to the 5500A as shown in Figure 4-5.

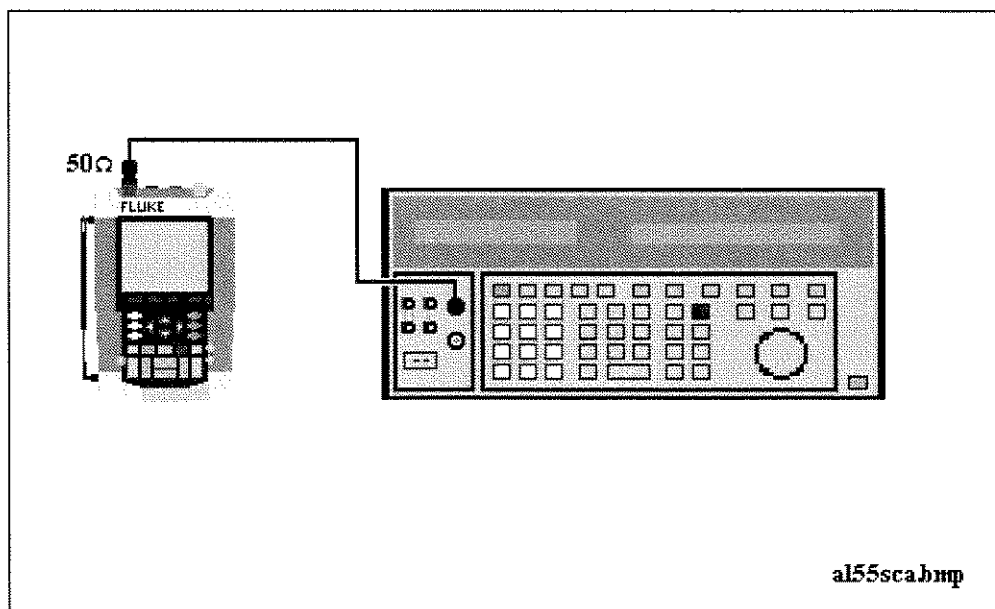











Figure 4-5. 5500A Scope Output to Test Tool Input A

2. Set the 5500A to source a 8 ms time marker (MODE marker).
3. Select the following test tool setup:
 - Reset the test tool
 - Using  and  select manual vertical ranging, and set the Input A sensitivity range to 5V (probe A is 10:1, so input sensitivity is 500 mV/div).
 - Using  change the time base to select manual time base ranging, and lock the time base on 10 ms/div).
 - Using  move the trace to the left. After moving the trace 2 divisions, the trigger delay time with respect to the first vertical grid line will be indicated

in the center of the display bottom.

Adjust the trigger delay time to 8.000 ms (A \bar{J} →| 8.00 ms)

- Using  set the time base on 10 μ s/div.
4. Using  move the trace to the right until the indicated trigger delay is 7.990 ms.
 5. Examine the rising edge of the time marker pulse at the height of the trigger level indicator top. Verify that the rising edge is at the second grid line from the left. The allowed deviation is ± 3 pixels, see Figure 4-6.
 6. Select the following test tool setup:
 - Using  change the time base to select manual time base ranging, and lock the time base on 10 ms/div).
 - Using  move the trace to adjust the trigger delay time to 800.0 μ s (A \bar{J} 800.0 μ s).
 - Using  set the time base on 1 μ s/div.
 7. Set the 5500A to source a 0.8 ms time marker (MODE marker).
 8. Using  move the trace to the right until the indicated trigger delay is 799.0 μ s.
 9. Examine the rising edge of the time marker pulse at the vertical height of the trigger level indicator top. Verify that the rising edge is at the second grid line from the left. The allowed deviation is ± 3 pixels, see Figure 4-6.

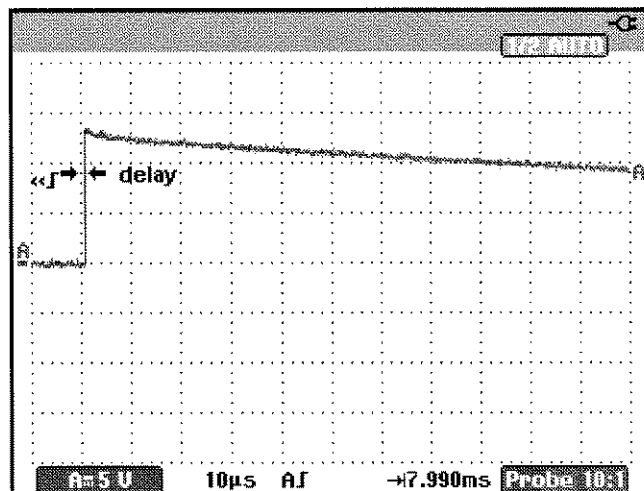

Figure 4-6. Time Base Verification

190c-1b1.bmp

4.6.9 Input A Trigger Sensitivity Test

Proceed as follows to test the Input A trigger sensitivity:

1. Connect the test tool to the 5500A as for the previous test (see Figure 4-5).
2. Select the following test tool setup:
 - Reset the test tool





- Using  and  change the sensitivity range to select manual sensitivity ranging, and lock the Input A sensitivity range on 2 V/div.
3. Using  select the time base indicated under the second column of Table 4-8.
 4. Set the 5500A to source the leveled sine wave for the appropriate test tool model.
 5. Adjust the 5500A output voltage until the displayed trace has the trigger amplitude indicated under the last column of Table 4-8.
 6. Verify that the signal is well triggered.
If it is not, press , then using  enable the up/down arrow keys for manual Trigger Level adjustment. Adjust the trigger level and verify that the signal will be triggered now. The trigger level is indicated by the trigger icon (J).
 7. Continue through the test points.
 8. When you are finished, set the 5500A to Standby.

Table 4-8. Input A Trigger Sensitivity Test Points

UUT Model	UUT Time base	5500A SC... MODE levsin		UUT Trigger Amplitude
		Initial Input Voltage	Frequency	
ALL	200 ns/div	100 mV pp	5 MHz	0.5 div
192B	10 ns/div	400 mV pp	60 MHz	1 div
	10 ns/div	800 mV pp	100 MHz	2 div
196B-C	10 ns/div	400 mV pp	100 MHz	1 div
	10 ns/div	800 mV pp	150 MHz	2 div
199B-C	10 ns/div	400 mV pp	200 MHz	1 div
	10 ns/div	800 mV pp	250 MHz	2 div

4.6.10 Input A AC Voltage Accuracy (HF) & Bandwidth Test

Proceed as follows to test the Input A high frequency automatic scope ac voltage measurement accuracy, and the bandwidth:











1. Connect the test tool to the 5500A as for the previous test (see Figure 4-5).
2. Select the following test tool setup:
 - Recall the created SETUP 1 (see section 4.4.3): press ,  **RECALL** , select **SCREEN+SETUP**  **1** , press  **RECALL SETUP** .
 - Press  , then press  **READING 1** , and select  **on A | V ac**.
 - Press  to select autoranging (**AUTO** in upper right LCD edge)
 - Using  and  change the sensitivity range to select manual sensitivity ranging, and lock the Input A sensitivity range on 500 mV/div. (**AUTO** in upper right LCD edge disappears)
3. Set the 5500A to source a sine wave, to the first test point in Table 4-9.
4. Observe the Input A reading and check to see if it is within the range shown under the appropriate column.
5. Continue through the test points.
6. When you are finished, set the 5500A to Standby.

Table 4-9. HF AC Voltage Verification Points

UUT Model	5500A SC... MODE levsin		UUT Reading A
	Voltage	Frequency	
all	2.545 Vpp	1 MHz	835 mV to 965 mV
all	2.545 Vpp	25 MHz	790 mV to 1.010 V
192B	2.545 Vpp	60 MHz	>630 mV
196B-C	2.545 Vpp	100 MHz	>630 mV
199B-C	2.545 Vpp	200 MHz	>630 mV

4.6.11 Input B Trigger Sensitivity Test

Proceed as follows to test the Input B trigger sensitivity:

1. Connect the test tool to the 5500A as shown in Figure 4-7.

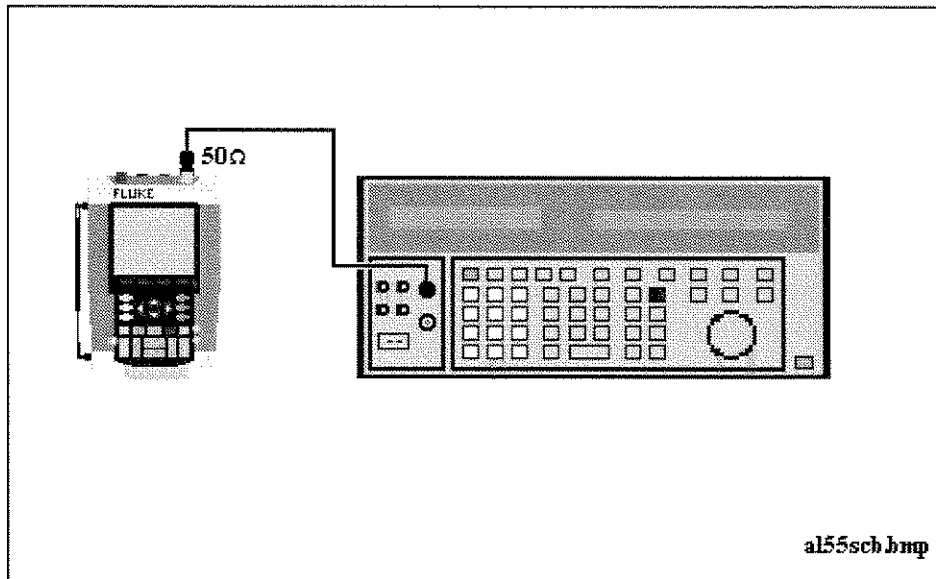

Figure 4-7. 5500A Scope Output to Test Tool Input B

a155sch.bmp

2. Select the following test tool setup:
 - Reset the test tool
 - Press and use to turn Input B on.
 - Press and use to turn Input A off.
 - Using move the Input B trace zero to the center grid line.
 - Press and use to select Input B as trigger source.
 - Using and change the sensitivity range to select manual sensitivity ranging, and lock the Input B sensitivity range on 2 V/div.
3. Using select the time base indicated under the first column of Table 4-10.
4. Set the 5500A to source the leveled sine wave given in the first row of Table 4-10.
5. Adjust the 5500A output voltage until the displayed trace has the amplitude indicated under the appropriate column of Table 4-10.
6. Verify that the signal is well triggered.
If it is not, press , then using enable the up/down arrow keys for manual Trigger Level adjustment. Adjust the trigger level and verify that the signal will be triggered now. The trigger level is indicated by the trigger icon (J).
7. Continue through the test points.
8. When you are finished, set the 5500A to Standby.

Table 4-10. Input B Trigger Sensitivity Test Points

UUT Model	UUT Time base	5500A SC... MODE levsin		UUT Trigger Amplitude
		Initial Input Voltage	Frequency	
ALL	200 ns/div	100 mV pp	5 MHz	0.5 div
192B	10 ns/div	400 mV pp	60 MHz	1 div
	10 ns/div	800 mV pp	100 MHz	2 div
196B-C	10 ns/div	400 mV pp	100 MHz	1 div
	10 ns/div	800 mV pp	150 MHz	2 div
199B-C	10 ns/div	400 mV pp	200 MHz	1 div
	10 ns/div	800 mV pp	250 MHz	2 div

4.6.12 Input B AC Voltage Accuracy (HF) & Bandwidth Test

Proceed as follows to test the Input B high frequency automatic scope ac voltage measurement accuracy, and the bandwidth:











1. Connect the test tool to the 5500A as for the previous test (see Figure 4-7).
2. Select the following test tool setup:
 - Recall the created SETUP 1 (see section 4.4.3): press  ,  **RECALL** , select **SCREEN+SETUP**  **1** , press  **RECALL SETUP** .
 - Press  **SCOPE** , then press  **READING 2** , and select  **on B** |  **V ac**.
 - Press  to select autoranging (**AUTO** in upper right LCD edge)
 - Using  and  change the sensitivity range to select manual sensitivity ranging, and lock the Input B sensitivity range on 500 mV/div.
3. Set the 5500A to source a sine wave, to the first test point in Table 4-11.
4. Observe the Input B reading and check to see if it is within the range shown under the appropriate column of table 4-11.
5. Continue through the test points.
6. When you are finished, set the 5500A to Standby.

Table 4-11. HF AC Voltage Verification Points

UUT Model	5500A SC... MODE levsin		UUT Reading B
	Voltage	Frequency	
all	2.545 Vpp	1 MHz	835 mV to 965 mV
all	2.545 Vpp	25 MHz	790 mV to 1.010 V
192B	2.545 Vpp	60 MHz	>630 mV
196B-C	2.545 Vpp	100 MHz	>630 mV
199B-C	2.545 Vpp	200 MHz	>630 mV

4.6.13 Video test using the Video Pattern Generator

You can skip this test if you do the test **4.6.14 Video test using the SC600 Scope Calibration option**

Only one of the systems NTSC, PAL, PALplus, or SECAM has to be verified.

Proceed as follows:

1. Connect the test tool to the TV Signal Generator as shown in Figure 4-8.

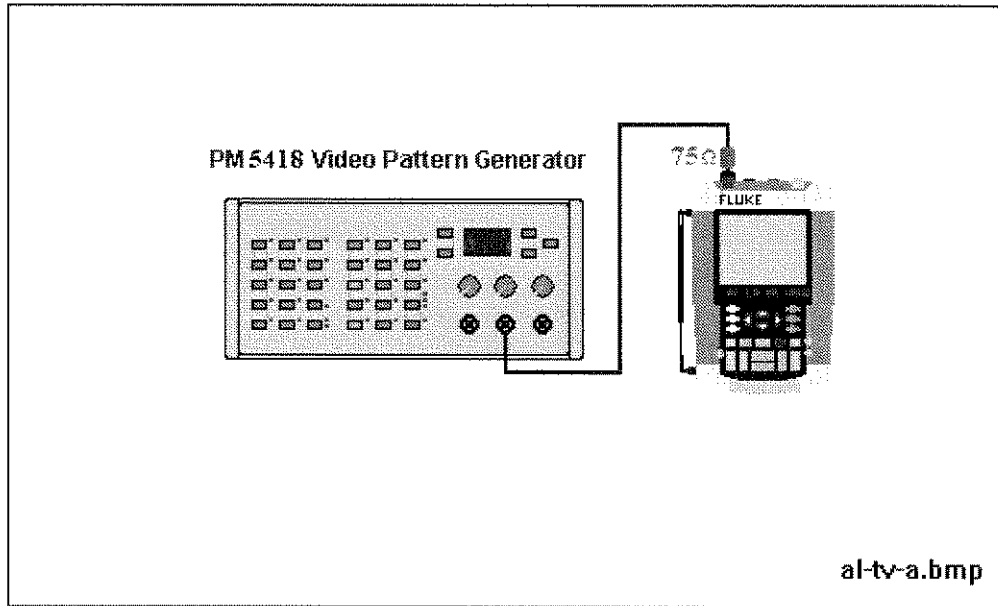











Figure 4-8. Test Tool Input A to TV Signal Generator

2. Select the following test tool setup:
 - Reset the test tool
 - Press , then press  to open the Trigger Options menu.
 - Choose **VIDEO on A...**, then from the shown opened menu choose **Polarity: POSITIVE | PAL (or NTSC PALplus SECAM)**
 - Press  to select **ALL LINES**
 - Press  to enable the arrow keys for selecting the video line number.
 - Using   select line number:
 - 622 for PAL, PALplus, or SECAM
 - 525 for NTSC.
 - Using  and  set the Input A sensitivity to 2 V/div (the actual probe setting is 10:1).
 - Using  select the time base to 20 μs/div.
3. Set the TV Signal Generator to source a signal with the following properties:
 - the system selected in step 2
 - gray scale

- sync pulse amplitude > 0.7 div.
 - chroma amplitude zero.
4. Observe the trace, and check to see if the test tool triggers on line number:
 - 622 for PAL or SECAM, see Figure 4-9
 - 525 for NTSC, see Figure 4-10.

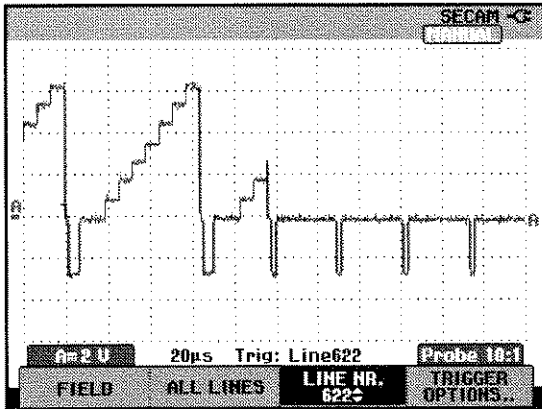

Figure 4-9. Trace for PAL/SECAM line 622

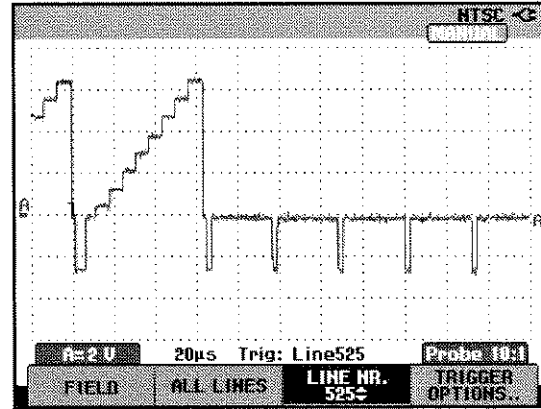

Figure 4-10. Trace for NTSC line 525

5. Using select line number:
 - 310 for PAL or SECAM
 - 262 for NTSC
6. Observe the trace, and check to see if the test tool triggers on:
 - line number 310 for PAL or SECAM, see Figure 4-11.
 - line number 262 for NTSC, see Figure 4-12.

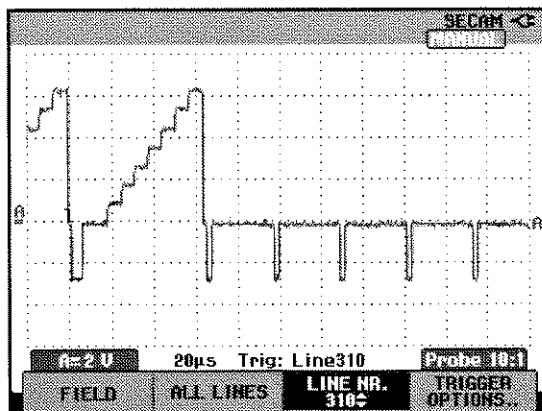

Figure 4-11. Trace for PAL/SECAM line 310

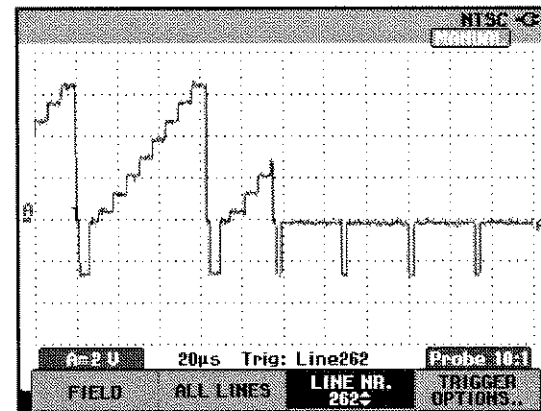

Figure 4-12. Trace for NTSC line 262

7. Apply the inverted TV Signal Generator signal to the test tool.
Invert the signal by using a Banana Plug to BNC adapter (Fluke PM9081/001) and a Banana Jack to BNC adapter (Fluke PM9082/001), as shown in Figure 4-13.

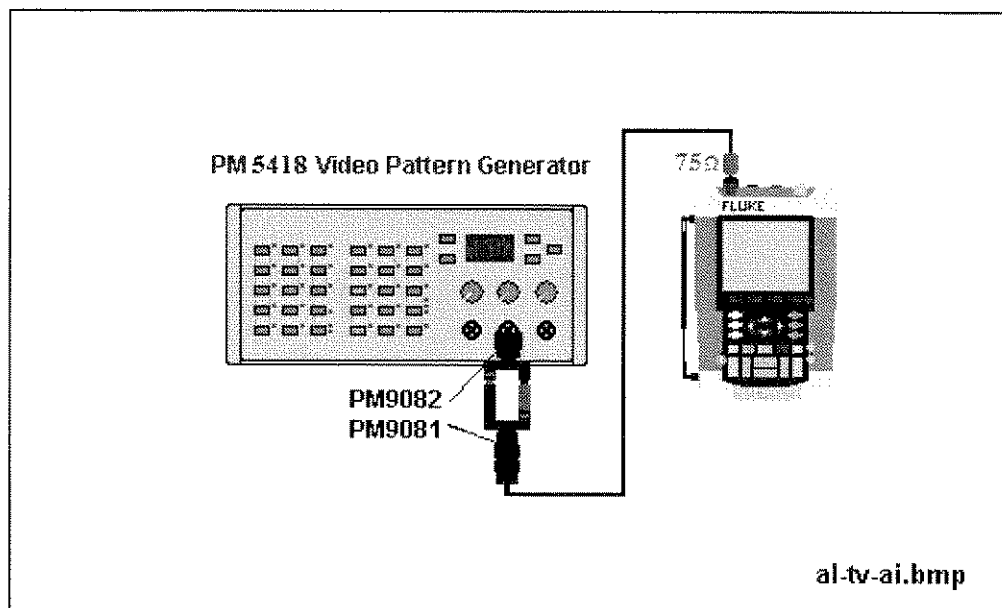

Figure 4-13. Test Tool Input A to TV Signal Generator Inverted

al-tv-ai.bmp

8. Select the following test tool setup:
 - Press to open the Trigger Options menu.
 - Choose **VIDEO on A...**, then from the shown opened menu choose **Polarity: NEGATIVE | PAL (or NTSC PALplus SECAM)**
9. Using select line number 310 (PAL or SECAM) or 262 (NTSC)
10. Observe the trace, and check to see if the test tool triggers on line number 310 (PAL or SECAM, see Figure 4-14), or line number 262 (NTSC, see Figure 4-15).

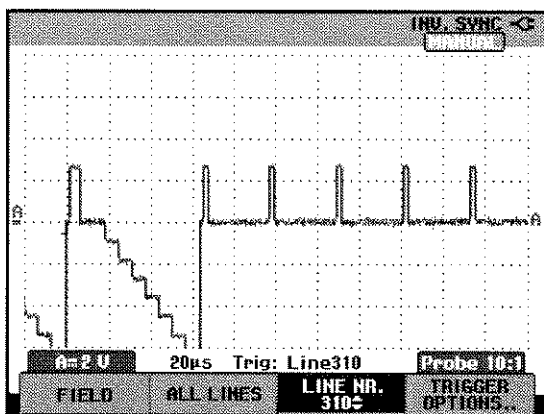

Figure 4-14. Trace for PAL/SECAM line 310 Negative Video

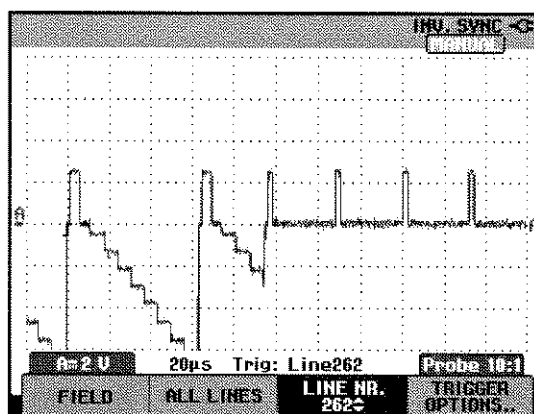

Figure 4-15. Trace for NTSC line 262 Negative Video

4.6.14 Video test using SC600 Scope Calibration Option

You can skip this test if you did test **4.6.13 Video test using the Video Pattern Generator**.

Only one of the systems NTSC, PAL, PALplus, or SECAM has to be verified.

Proceed as follows:

1. Connect the test tool to the calibrator as shown in Figure 4-16.

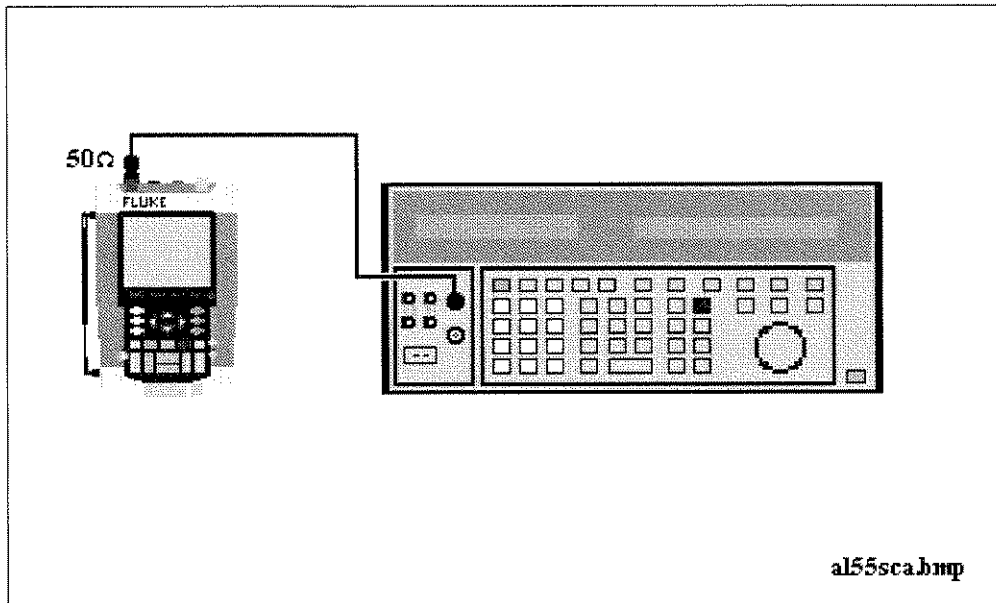















Figure 4-16. Test Tool Input A to TV Signal Generator

2. Select the following test tool setup:
 - Reset the test tool
 - Press , then press  to open the Trigger Options menu.
 - Choose **VIDEO on A...**, then from the shown opened menu choose
Polarity: POSITIVE | PAL (or NTSC PALplus SECAM)
 - Press  to select **ALL LINES**
 - Press  to enable the arrow keys for selecting the video line number.
 - Using   select line number:
 622 for PAL, PALplus, or SECAM
 525 for NTSC.
 - Using  and  set the Input A sensitivity to 2 V/div (the actual probe setting is 10:1).
 - Using  select the time base to 20 μ s/div.
3. Set the calibrator to mode video with amplitude +100%. Set format and marker line number to :
 - PAL 622 (even), for PAL and PALplus
 - SECAM 622 (even), for SECAM
 - NTSC 262 even, for NTSC.
4. Observe the trace, and check to see if the test tool triggers on the negative pulse before the marker pulse (see Figure 17).

5. Using   select test tool line number:
310 for PAL, PALplus or SECAM
262 for NTSC
6. Set the calibrator format and marker line number to :
PAL 310 (odd), for PAL and PALplus
SECAM 310 (odd), for SECAM
NTSC 262 odd, for NTSC.
7. Observe the trace, and check to see if the test tool triggers on the negative pulse before the marker.
8. Select the following test tool setup:
 - Press  to open the Trigger Options menu.
 - Choose **VIDEO on A...** , then from the shown opened menu choose
Polarity: ■ NEGATIVE | ■ PAL (or ■ NTSC ■ PALplus ■ SECAM)
9. Set the calibrator video trigger output signal to -100%
10. Using   select line number 310 (PAL, PALplus or SECAM) or 262 (NTSC)
11. Set the calibrator format and marker line number to :
PAL 310 (odd), for PAL and PALplus
SECAM 310 (odd), for SECAM
NTSC 262 odd, for NTSC.
12. Observe the trace, and check to see if the test tool triggers on the positive pulse before the marker.

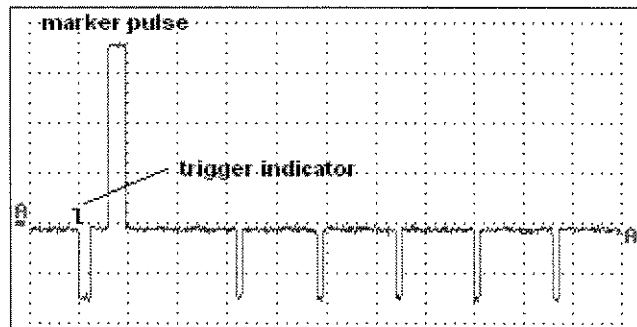

Figure 4-17. SC600 Marker Pulse

video-sc600.bmp

4.7 External Trigger Level Test

Proceed as follows:

1. Connect the test tool to the 5500A as shown in Figure 4-18.

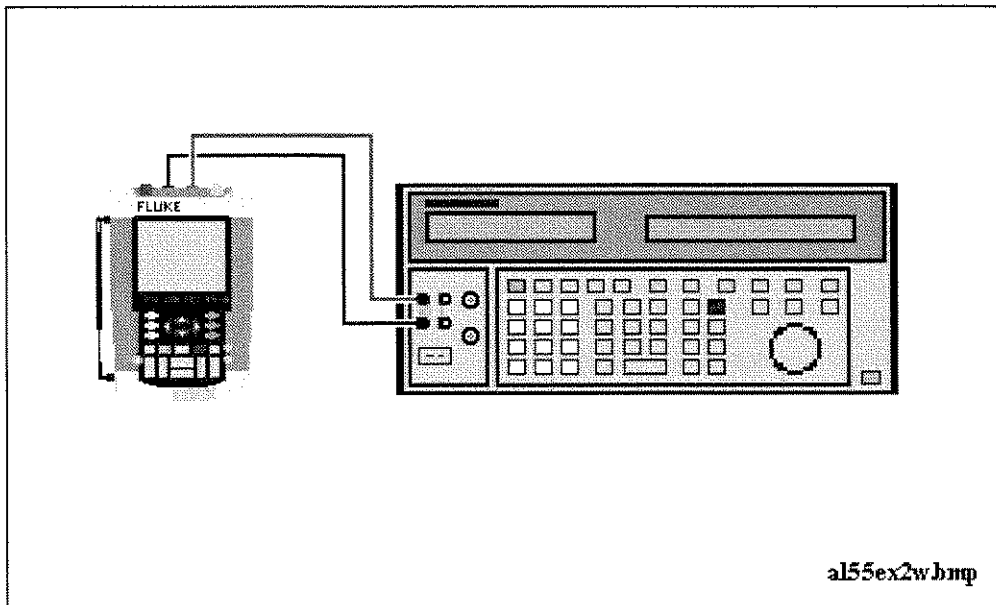









Figure 4-18. Test Tool Meter/Ext Input to 5500A Normal Output

2. Select the following test tool setup:
 - Reset the test tool
 - Press 
 - Using  select the **TRIGGER OPTIONS...** menu
 - Select **On Edges...** from the **TRIGGER OPTIONS** menu
 - Select **Update:** **Single Shot** | **Noise reject Filter:** **On**
 - Using  **EDGE TRIG** select **Ext**.
 - Using  **SLOPE** select positive slope triggering (trigger icon ).
 - Using  **Ext LEVEL** select **1.2 V**
3. Set the 5500A to source 0.4V dc.
4. Verify that no trace is shown on the test tool display, and that the status line at the display top shows **SINGLE MANUAL** or **SINGLE WAITING**. If the display shows the trace, and status **SINGLE HOLD** then press  to re-arm the test tool for a trigger.
5. Set the 5500A to source 1.7 V
6. Verify that the test tool is triggered by checking that the trace becomes visible. To repeat the test, start at step 3.
7. Set the 5500A to Standby.

4.8 Meter (DMM) Tests

4.8.1 Meter DC Voltage Accuracy Test

WARNING

Dangerous voltages will be present on the calibration source and connecting cables during the following steps. Ensure that the calibrator is in standby mode before making any connection between the calibrator and the test tool.

Proceed as follows to test the meter dc voltage measurement accuracy:





1. Connect the test tool to the 5500A as for the previous test (see Figure 4-18).
2. Select the following test tool setup:
 - Press  (this key will toggle the menu bar on and off if the test tool is already in the meter mode)
 - Press  to open the Measurement menu, and select **V dc**
 - Press  to select MANUAL ranging; use   to select the ranges.
3. Set the range to the first test point in Table 4-12.
4. Set the 5500A to source the appropriate dc voltage.
5. Observe the reading and check to see if it is within the range shown under the appropriate column.
6. Continue through the test points.
7. When you are finished, set the 5500A to 0 (zero) Volt, and to Standby.

Table 4-12. Meter Volts dc Measurement Verification Points

Range	5500A output V dc	Meter Reading
500.0 mV	+ 500 mV	497.0 to 503.0
	- 500 mV	-497.0 to -503.0
	0 mV	-0.5 to +0.5
5.000 V	+ 5.000 V	4.970 to 5.030
	- 5.000 V	-4.970 to -5.030
50.00 V	+ 50.00 V	49.70 to 50.30
	- 50.00 V	-49.70 to -50.30
500.0 V	+ 500.0 V	497.0 to 503.0
	- 500.0 V	-497.0 to -503.0
1100 V	+ 1000 V	0.990 to 1.010
	- 1000 V	-0.990 to -1.010

4.8.2 Meter AC Voltage Accuracy & Frequency Response Test

Warning

Dangerous voltages will be present on the calibration source and connecting cables during the following steps. Ensure that the calibrator is in standby mode before making any connection between the calibrator and the test tool.

Proceed as follows to test the ac voltage measurement accuracy:







1. Connect the test tool to the 5500A as for the previous test (see Figure 4-18).
2. Select the following test tool setup:
 - Press  **METER**
 - Press  to open the Measurement menu, and select **V ac**
 - Press  to select MANUAL ranging; use   to select the ranges
3. Set the range to the first test point in Table 4-13.
4. Set the 5500A to source the appropriate ac voltage.
5. Observe the reading and check to see if it is within the range shown under the appropriate column.
6. Continue through the test points.
7. When you are finished, set the 5500A to 0 (zero) Volt, and to Standby.

Table 4-13. Meter Volts AC Measurement Verification Points

Range	5500A output V ac	Frequency	Meter Reading
500.0 mV	500.0 mV	60 Hz	494.0 to 506.0
		1 kHz	486.0 to 514.0
		10 kHz	>350.0
5.000 V	5.000 V	60 Hz	4.940 to 5.060
		1 kHz	4.860 to 5.140
		10 kHz	>3.500
50.00 V	50.00 V	60 Hz	49.40 to 50.60
		1 kHz	48.60 to 51.40
		10 kHz	>35.00
500.0 V	500.0 V	60 Hz	494.0 to 506.0
		1 kHz	486.0 to 514.0
		10 kHz	>350.0
1100 V (1.1 kV)	1000 V	60 Hz	0.980 to 1.020
		1 kHz	0.960 to 1.040
		10 kHz	> 0.700



4.8.3 Continuity Function Test

Proceed as follows:

1. Select the following test tool setup:
 - Press  **METER**
 - Press  to open the Measurement menu, and select **■ Continuity**
2. Connect the test tool to the 5500A as for the previous test (see Figure 4-18).
3. Set the 5500A to 20 Ω . Use the 5500A “COMP 2 wire” mode.
4. Listen to hear that the beeper is on.
5. Set the 5500A to 80 Ω .
6. Listen to hear that the beeper is off.
7. When you are finished, set the 5500A to Standby.

4.8.4 Diode Test Function Test

Proceed as follows to test the Diode Test function :

1. Select the following test tool setup:
 - Press  **METER**
 - Press  to open the Measurement menu, and select **■ Diode**
2. Connect the test tool to the 5500A as for the previous test (see Figure 4-18).
3. Set the 5500A to **1 k Ω** . Use the 5500A “COMP 2 wire” mode.
4. Observe the main reading and check to see if it is within **0.4 V** and **0.6 V**.
5. Set the 5500A to **1 V dc**.
6. Observe the main reading and check to see if it is within **0.975 V** and **1.025 V**.
7. When you are finished, set the 5500A to Standby.

4.8.5 Ohms Measurements Test

Proceed as follows to test the Ohms measurement accuracy:

1. Connect the test tool to the 5500A as shown in Figure 4-19.

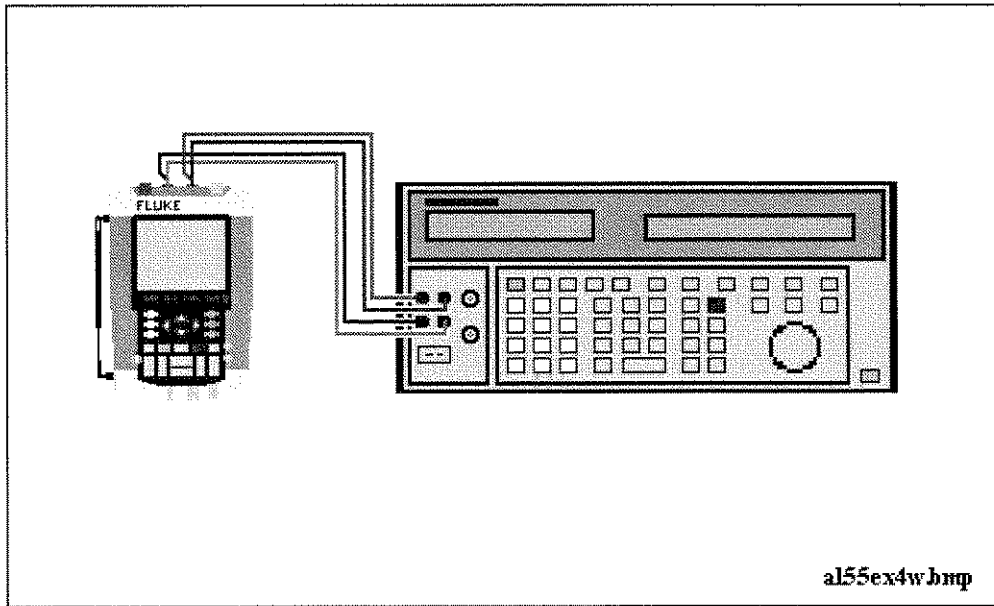

Figure 4-19. Test Meter Tool Input to 5500A Normal Output 4-Wire

al55ex4w.bmp



2. Select the following test tool setup:
 - Press **METER**
 - Press  to open the Measurement menu, and select **Ohms**
 - Press  to select AUTO ranging.
3. Set the 5500A to source the appropriate resistance value for the first test point in Table 4-14.
Use the 5500A “COMP 2 wire” mode for the verifications up to and including 50 kΩ. For the higher values, the 5500A will turn off the “COMP 2 wire” mode.
4. Observe the reading and check to see if it is within the range shown under the appropriate column.
5. Continue through the test points.
6. When you are finished, set the 5500A to Standby.

Table 4-14. Resistance Measurement Verification Points

5500A output	Meter Reading
0Ω	0.0 to 0.5
400Ω	397.1 to 402.9
4 kΩ	3.971 to 4.029
40 kΩ	39.71 to 40.29
400 kΩ	397.1 to 402.9
4 MΩ	3.971 to 4.029
30 MΩ	29.77 to 30.23

4.9 Probe Calibration Generator Test

To verify the internal probe calibration square wave generator, you can do a Probe Calibration as described in section 5.8. If no square wave appears on the screen, either

- the probe is defective: try another probe, check the probe with an external voltage in a scope application,

or

- the internal square wave generator is defective.

This is the end of the Performance Verification Procedure.

Chapter 5

Calibration Adjustment

Title	Page
5.1 General.....	5-3
5.1.1 Introduction.....	5-3
5.1.2 Calibration number and date.....	5-3
5.1.3 General Instructions.....	5-3
5.1.4 Equipment Required For Calibration	5-4
5.2 Calibration Procedure Steps.....	5-4
5.3 Starting the Calibration	5-4
5.4 Contrast Calibration Adjustment	5-6
5.5 Warming Up & Pre-Calibration	5-7
5.6 Final Calibration	5-8
5.6.1 Input A LF-HF Gain	5-8
5.6.2 Input B LF-HF Gain.....	5-9
5.6.3 Input A&B LF-HF Gain.....	5-11
5.6.4 Input A&B Position	5-12
5.6.5 Input A&B Volt Gain	5-13
5.6.6 DMM Volt Gain	5-14
5.6.7 Input A & B, and DMM Zero	5-15
5.6.8 DMM Ohm Gain.....	5-16
5.6.9 Calculate Gain.....	5-17
5.7 Save Calibration Data and Exit.....	5-17
5.8 Probe Calibration	5-19

5.1 General



5.1.1 Introduction

The following information, provides the complete Calibration Adjustment procedure for the Fluke 192B/196B-C/199B-C ScopeMeter test tool (referred to as test tool). The test tool allows closed-case calibration using known reference sources. It measures the reference signals, calculates the correction factors, and stores the correction factors in RAM. After completing the calibration, the correction factors can be stored in FlashROM.

The test tool should be calibrated after repair, or if it fails the performance test. The test tool has a normal calibration cycle of one year.

5.1.2 Calibration number and date

When storing valid calibration data in FlashROM after performing the calibration adjustment procedure, the calibration date is set to the actual test tool date, and calibration number is raised by one. To display the calibration date and - number:

1. Press , then press  to see the Version & Calibration data (see Figure 5.1).
2. Press  to return to exit the Version & Calibration screen.

Version & Calibration	
Model Number :	199C
Software Version:	U05.00
Calibration Number:	#1
Calibration Date:	01/01/2002
Battery Refresh Date:	01/01/2002

wm-verscal.bmp

Figure 5-1. Version & Calibration Data

Note:

The calibration date and calibration number will not be changed if only the Contrast Calibration Adjustment and /or the Probe Calibration is done

5.1.3 General Instructions

Follow these general instructions for all-calibration steps:

- Allow the 5500A to satisfy its specified warm-up period. For each calibration point , wait for the 5500A to settle.
- The required warm up period for the test tool is included in the WarmingUp & PreCal calibration step.
- Ensure that the test tool battery is charged sufficiently.
- Power the test tool via the BC190 Battery Charger/Power Adapter

5.1.4 Equipment Required For Calibration

The primary source instrument used in the calibration procedures is the Fluke 5500A. If a 5500A is not available, you can substitute another calibrator as long as it meets the minimum test requirements.

- Fluke 5500A Multi Product Calibrator, including SC300 or SC600 Oscilloscope Calibration Option.
- Stackable Test Leads (4x), supplied with the 5500A.
- 50Ω Coax Cable (2x), for example Fluke PM9091 (1.5m) or PM9092 (0.5m).
- 50Ω feed through termination, Fluke PM9585.
- Male BNC to Dual Female BNC Adapter (1x), Fluke PM9093/001.
- Dual Banana Plug to Female BNC Adapter (1x), Fluke PM9081/001.

5.2 Calibration Procedure Steps

To do a **complete** calibration adjustment you must do all following steps:





1. Select the Calibration Mode, section 5.3
2. Do the Contrast Calibration Adjustment, section 5.4
3. Do the WarmingUp & PreCalibration, section 5.5
4. Do the Final Calibration, section 5.6
5. Save the Calibration Data and Exit the calibration mode, section 5.7
6. Do the probe Calibration, section 5.8

The following **partial** calibrations are allowed:

- Contrast calibration, do the above-mentioned steps 1, 2, and 5.
If during normal operation the display cannot be made dark or light enough, or if the display after a test tool reset is too light or too dark, you can do this calibration.
- Probe calibration, do the above-mentioned step 6.
The probe calibration matches the probe to the used input channel.

5.3 Starting the Calibration



Follow the steps below to start the calibration:

1. Power the test tool via the power adapter input using the BC190 power adapter.
2. Check the actual test tool date, and adjust the date if necessary (the calibration date will become the test tool date when saving the calibration data):
 - Press  (toggles the menu bar on-off)
 - press  to open the **OPTIONS** menu
 - using   select **DATE ADJUST...**
 - press  to open the **DATE ADJUST** menu
 - adjust the date if necessary.

3. Select the calibration mode.

The Calibration Adjustment Procedure uses built-in calibration setups, that can be accessed in the calibration mode.

To enter the calibration mode proceed as follows:

- Press and hold , press and release , release 





The display shows the **CAL MODE** (Calibration Adjustment) screen.

The display shows the calibration step **Warming Up (CL 0200)**, the calibration status **:IDLE (valid)** or **:IDLE (invalid)**, and the softkey menu.

Continue as indicated in section 5.2.

You can leave the calibration mode without changing the calibration data by turning the test tool off.

Explanation of screen messages and key functions.

When the test tool is in the calibration Mode, only the  to  soft keys, the  key, and the  key can be operated, unless otherwise stated.

The calibration adjustment screen shows the actual calibration step (name and number) and its status: **Cal Name (CL nnnn) :Status (...)**





Cal Name Name of the selected calibration step, e.g. **WarmingUp**

(CL nnnn) Number of the calibration step

Status (...) can be:

- IDLE (valid)** After (re)entering this step, the calibration process is not started. The calibration data of this step are valid. This means that the last time this step was done, the calibration was successful. It does not necessarily mean that the unit meets the specifications related to this step!
- IDLE (invalid)** After (re)entering this step, the calibration process is not started. The calibration data are invalid. This means that the last time this step was done, the calibration was not successful. Most probably the unit will not meet the specifications if the actual calibration data are saved.
- BUSY aaa% bbb%** Calibration adjustment step in progress; progress % for Input A and Input B. During WarmingUp the elapsed time is shown.
- READY** Calibration adjustment step finished.
- Error :xxxx** Calibration adjustment failed, due to wrong input signal(s) or because the test tool is defective.
If the error code is <5000 you can repeat the failed step.
If the error code is ≥5000 you must repeat the complete final calibration (start at 5.6.1).

Functions of the keys F1-F4 are:

- | | | |
|---|-------------|---|
|  | PREV | select the previous step |
|  | NEXT | select the next step |
|  | CAL | start the calibration adjustment of the actual step |
|  | EXIT | leave the calibration mode |

















5.4 Contrast Calibration Adjustment

After entering the calibration mode the display shows:

WarmingUp (CL 0200):IDLE (valid)

Do not press  now! If you did, turn the test tool off and on, and enter the calibration mode again.

Proceed as follows to adjust the maximum display darkness (CL 0100), the default contrast (CL 0110) , and the maximum display brightness (CL 0120).

1. Press  three times to select maximum darkness calibration **Contrast (CL 0100):**
2. Press  **CALIBRATE** . The display will show a dark test pattern, see Figure 5-2
3. Using   adjust the display to the maximum darkness at which the test pattern is only just visible.
4. Press  to return to the softkey menu.
5. Press  to select default contrast calibration **Contrast (CL 0110):**
6. Press  **CALIBRATE**. The display shows the test pattern at default contrast.
7. Using   set the display to optimal (becomes default) contrast.
8. Press  to return to the softkey menu.
9. Press  to select maximum brightness calibration **Contrast (CL 0120):**
10. Press  **CALIBRATE**. The display shows a bright test pattern.
11. Using   adjust the display to the maximum brightness, at which the test pattern is only just visible.
12. Press  to return to the softkey menu.
13. Now you can either
 - Exit, if only the Contrast had to be adjusted. Continue at Section 5.7.
 - or**
 - Do the complete calibration. Press  to select the next step (WarmingUp), and continue at Section 5.5.

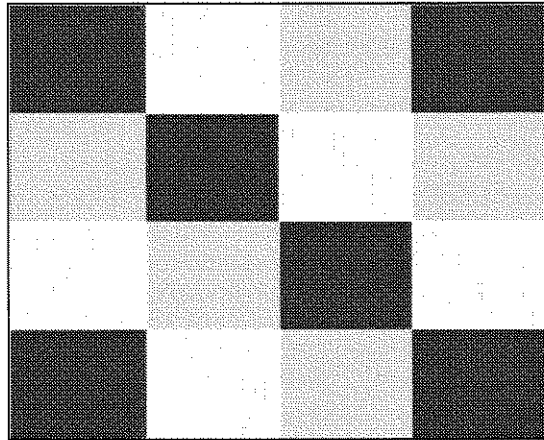

Figure 5-2. Display Test Pattern



5.5 Warming Up & Pre-Calibration

The WarmingUp & Pre-Calibration state will be entered after entering the calibration mode (section 5.3), or after selecting the next step if you have done the Contrast Calibration step CL 120 (section 5.4). The display will show **WarmingUp (CL 0200):IDLE (valid)** or **(invalid)**.

Unless you want to calibrate the display contrast only, you must always start the calibration adjustment at the **Warming Up (CL 0200)** step. Starting at another step will make the calibration invalid!

The WarmingUp & Pre-Calibration consists of a 30 minutes warming-up period, and several internal calibration adjustment steps that do not require input signals.

Proceed as follows to do the WarmingUp & Pre-Calibration:

1. Remove all input connections from the test tool.
2. Press  to start the Warming-Up & Pre-Calibration.
 The display shows the calibration step in progress, and its status.
 The first step is **WarmingUp (CL 0200) :BUSY 00:29:59**. The warming-up period is counted down from 00:29:59 to 00:00:00. Then the remaining pre-calibration steps are performed automatically. The entire procedure takes about 60 minutes.
3. Wait until the display shows **End Precal: READY**
 The PreCal data have now been stored in FlashROM.
 If you turn off the test tool now by accident, turn it on again immediately; now you can select the calibration mode, and continue with step 4 below (press  **NEXT** several times, see 5.6).
 If you turn off the instrument now, and you do not turn on immediately, the test tool has cooled down, and you must repeat the WarmingUp and PreCalibration (select the calibration mode and start at CL 0200).
4. Press  **NEXT** and continue at Section 5.6.

Error Messages

If error message **1000** is displayed during WarmingUp or PreCalibration step CL0215, the Main PCA hardware version is not suitable for the installed software version. Other error messages during WarmingUp or PreCalibration indicate that the test tool is defective, and should be repaired.

5.6 Final Calibration

Before starting the final calibration you must have done the WarmingUp & PreCalibration (section 5.5)!

The final calibration requires input conditions that will be described in each step. After starting a step, several steps that require the same input conditions will be done automatically. So if you start for example calibration step CL 0915, the calibration can include also step CL 0916, and at the end the display then shows CL 0916: READY

You must always start the Final Calibration at the first step, see Section 5.6.1. Starting at another step will make the calibration invalid!

If you proceeded to calibration step N (for example step CL 0620), then return to a previous step (for example step CL 0616) , and then calibrate this step, the complete final calibration becomes invalid; then you must repeat the calibration starting at 5.6.1.

It is allowed to repeat a step that shows the status :READY by pressing  again.

Error messages

Proceed as follows if an error message **ERROR: nnnn** is displayed during calibration:

- if $nnnn < 5000$ then check input signal and test leads, and repeat the current step by pressing  again.
- if $nnnn \geq 5000$ then check input signal and test leads, and repeat the final calibration starting at section 5.6.1.

If the error persists the test tool is defective.

5.6.1 Input A LF-HF Gain

Proceed as follows to do the Input A LF-HF Gain calibration:

1. Connect the test tool to the 5500A as shown in Figure 5-3.

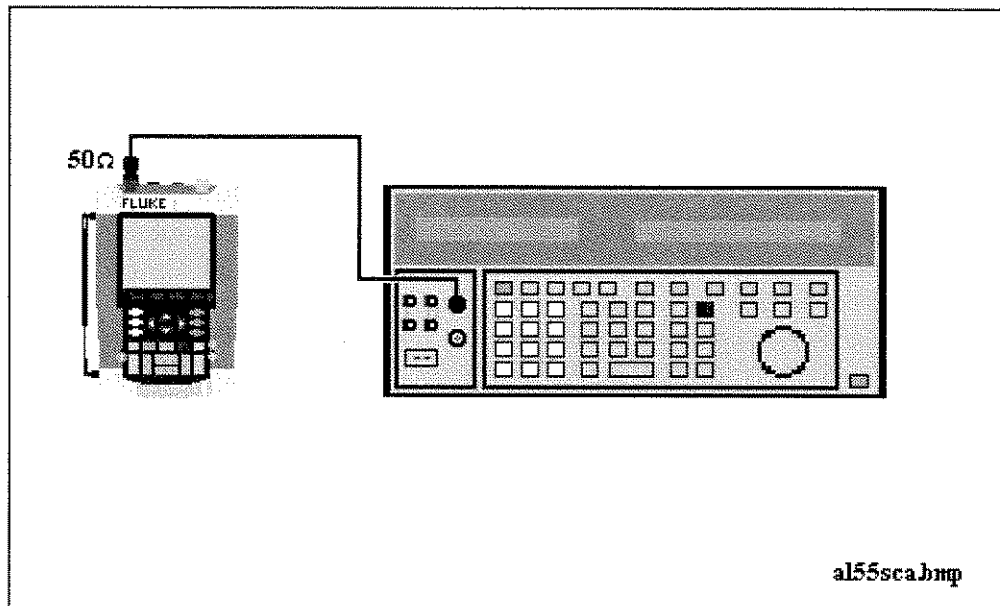

Figure 5-3. 5500A SCOPE Output to Test Tool Input A





2. The display must show step CL 0654. If it does not, then press  or  to select the first calibration step in Table 5-1.
3. Set the 5500A SCOPE output to source the signal required for the first calibration point in Table 5-1.
4. Set the 5500A in operate (OPR) or standby (STBY) as indicated.
5. Press  to start the calibration.
6. Wait until the display shows calibration status :READY .
7. Press  to select the next calibration step, set the 5500A to the next calibration point signal, and start the calibration.
Continue through all calibration points of Table 5-1.
8. When you are finished, set the 5500A to Standby.
9. Continue at Section 5.6.2.

Table 5-1. Input A LF-HF Gain Calibration Points

Cal step	UUT input signal	5500A Setting
CL 0654	none	STANDBY
CL 0400	0.5 Vpp square wave, 1 kHz	SCOPE edge, 0.5 Vpp, 1 kHz
CL 0704	none	STANDBY
CL 0420	0.5 Vpp square wave, 1 kHz	SCOPE edge, 0.5 Vpp, 1 kHz
CL 0480	0.5 Vpp sine wave, 50 kHz	SCOPE levsine, 0.5 Vpp, 50 kHz
CL 0481	0.5 Vpp sine wave Fluke 199B-C: 221 MHz Fluke 196B-C: 141 MHz Fluke 192B: 91 MHz	SCOPE levsine, 0.5 Vpp, 221 MHz 141 MHz 91 MHz

5.6.2 Input B LF-HF Gain

Proceed as follows to do the Input B LF-HF Gain calibration:

1. Press  to select the first calibration step in Table 5-2.
2. Connect the test tool to the 5500A as shown in Figure 5-4.

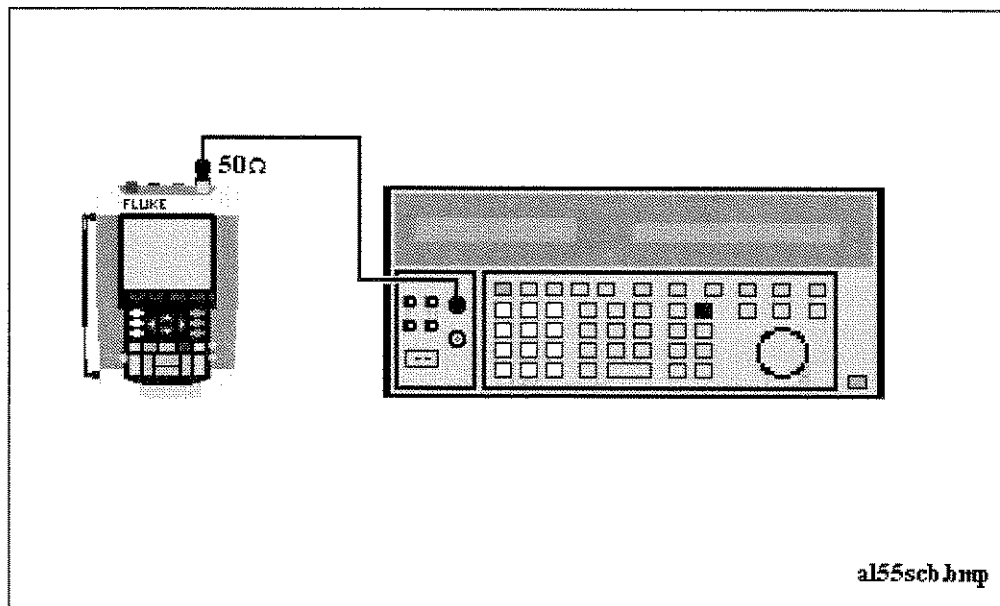

Figure 5-4. 5500A SCOPE Output to Test Tool Input B

a155scb.bmp



3. Set the 5500A SCOPE output to source the signal required for the first calibration point in Table 5-2.
4. Set the 5500A in operate (OPR) or standby (STBY) as indicated.
5. Press  to start the calibration.
6. Wait until the display shows calibration status :READY .
7. Press  to select the next calibration step, set the 5500A to the next calibration point signal, and start the calibration.
Continue through all calibration points of Table 5-2.
8. When you are finished, set the 5500A to Standby.
9. Continue at Section 5.6.3.

Table 5-2. Input B LF-HF Gain Calibration Points

Cal step	UUT input signal	5500A Setting
CL 0674	none	STANDBY
CL 0410	0.5 Vpp square wave, 1 kHz	SCOPE edge, 0.5 Vpp, 1 kHz
CL 0724	none	STANDBY
CL 0421	0.5 Vpp square wave, 1 kHz	SCOPE edge, 0.5 Vpp, 1 kHz
CL 0482	0.5 Vpp sine wave, 50 kHz	SCOPE levsine, 0.5 Vpp, 50 kHz
CL 0483	0.5 Vpp sine wave Fluke 199B-C: 221 MHz Fluke 196B-C: 141 MHz Fluke 192B: 91 MHz	SCOPE levsine, 0.5 Vpp, 221 MHz 141 MHz 91 MHz

5.6.3 Input A&B LF-HF Gain

Proceed as follows to do the Input A&B LF-HF Gain calibration.

1. Press  to select the first calibration step in Table 5-3.
2. Connect the test tool to the 5500A as shown in Figure 5-5.

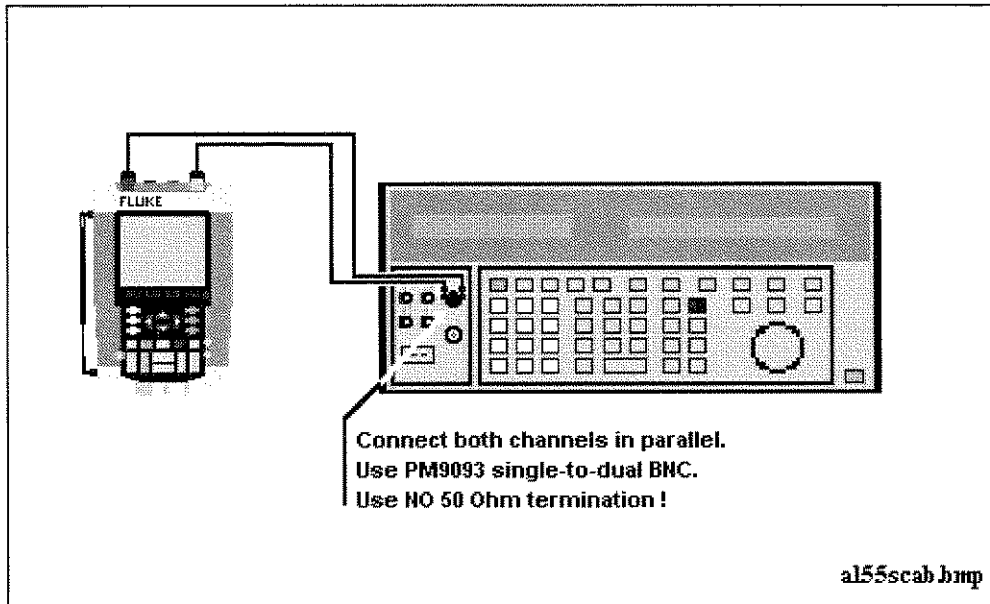

Figure 5-5. Test tool Input A&B to 5500 Scope Output

aiscab.bmp

3. Set the 5500A to supply a 1 kHz square wave (SCOPE, MODE volt, SCOPE Z 1 M Ω), to the first calibration point in Table 5-3.

Warning

Dangerous voltages will be present on the calibration source and connection cables during the following steps. Ensure that the calibrator is in standby mode before making any connection between the calibrator and the test tool.





4. Set the 5500A to operate (OPR).
5. Press  to start the calibration.
6. Wait until the display shows calibration status :READY.
7. Press  to select the next calibration step, set the 5500A to the next calibration point, and start the calibration. Continue through all calibration points of Table 5-3.
8. Set the 5500A to Standby, and continue at Section 5.6.4.

Table 5-3. Input A&B Gain Calibration Points

Cal step	UUT input value (5500A SCOPE, MODE volt, SCOPE Z 1 M Ω , 1 kHz)
CL 0660	300 mV
CL 0604	500 mV
CL 0637	none (5500 standby)
CL 0504	500 mV
CL 0624	none (5500 standby)
CL 0599 Not for software versions V05.01 and V05.02	10 mV
CL 0600	25 mV
CL 0601	50 mV
CL 0602	100 mV
CL 0603	250 mV
CL0662	2 V
CL 0605	1 V
CL 0606	2.5 V
CL 0607	5 V
CL0664	20 V
CL 0608	10 V
CL 0609	25 V
CL 0610	50 V (set 5500A to OPR!)

5.6.4 Input A&B Position

Proceed as follows to do the Input A&B Position calibration:

1. Press  to select calibration adjustment step **CL 0620** (software versions V05.01 and V05.02), or **CL 0619** (software versions V05.03 and newer).
2. Remove all Input A and Input B connections (open inputs).
3. Press  to start the calibration
4. Wait until the display shows calibration status **:READY**.
5. Continue at Section 5.6.5

5.6.5 Input A&B Volt Gain



Warning

Dangerous voltages will be present on the calibration source and connection cables during the following steps. Ensure that the calibrator is in standby mode before making any connection between the calibrator and the test tool.

Proceed as follows to do the Input A&B Volt Gain calibration.

1. Press  to select the first calibration step in Table 5-4.
2. Connect the test tool to the 5500A as shown in Figure 5-6.

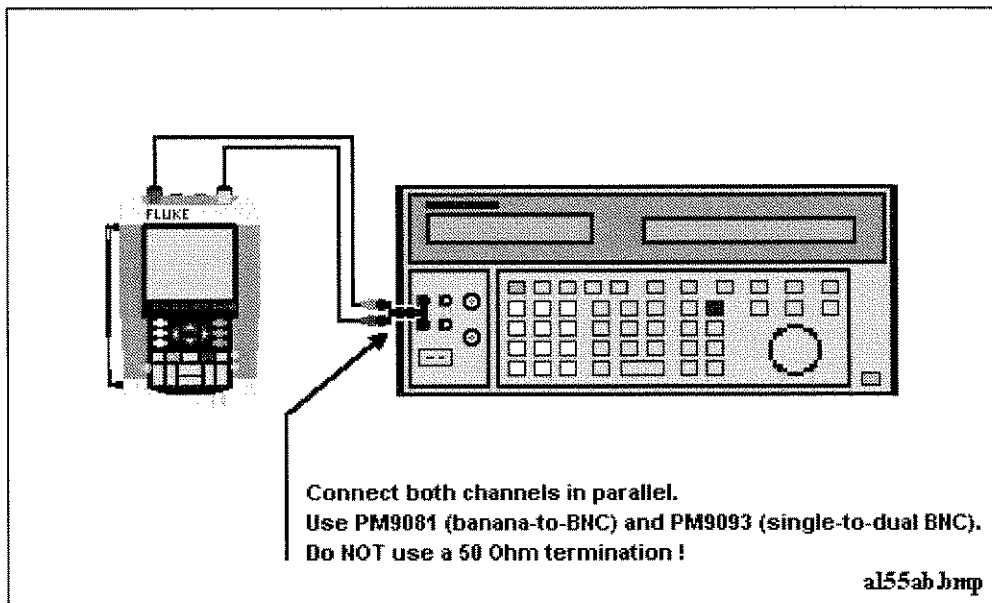

Figure 5-6. Test tool Input A&B to 5500 Normal Output



3. Set the 5500A to supply a DC voltage (NORMAL output), to the first calibration point in Table 5-4.
4. Set the 5500A to operate (OPR).
5. Press  to start the calibration.
6. Wait until the display shows calibration status :READY.
7. Press  to select the next calibration step, set the 5500A to the next calibration point, and start the calibration. Continue through all calibration points of Table 5-4.
8. Set the 5500A to Standby, and continue at Section 5.6.6.

Table 5-4. Input A&B Gain Calibration Points

Cal step	UUT input value (5500A NORMAL)
CL 0824	250 mV
CL 0799 Not for software versions V05.01 and V05.02	5 mV
CL 0800	12.5 mV
CL 0801	25 mV
CL 0802	50 mV
CL 0803	125 mV
CL 0805	500 mV
CL 0806	1.25 V
CL 0807	2.5 V
CL 0808	5 V
CL 0809	12.5 V
CL 0810	25 V
CL 0811	50 V (set 5500A to OPR!)
CL 0812	125 V
CL 0813	250 V

5.6.6 DMM Volt Gain



Warning

Dangerous voltages will be present on the calibration source and connection cables during the following steps. Ensure that the calibrator is in standby mode before making any connection between the calibrator and the test tool.

Proceed as follows to do the DMM Volt Gain calibration.

1. Press  to select the first calibration step in Table 5-5.
2. Connect the test tool to the 5500A as shown in Figure 5-7.

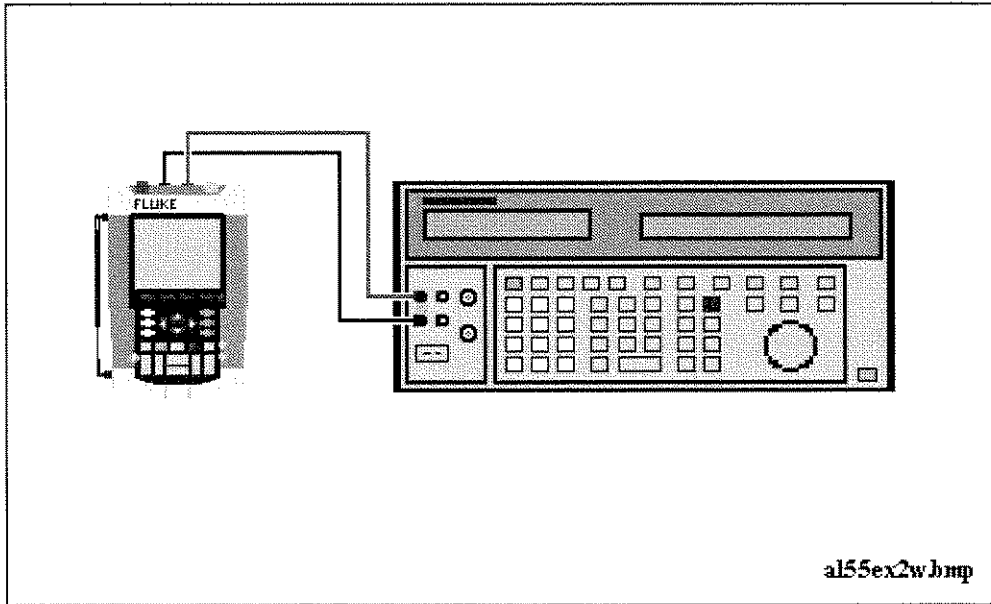

Figure 5-7. 5500A NORMAL Output to Test Tool Banana Input



3. Set the 5500A to supply a DC voltage, to the first calibration point in Table 5-5.
4. Set the 5500A to operate (OPR).
5. Press  to start the calibration.
6. Wait until the display shows calibration status :READY.
7. Press  to select the next calibration step, set the 5500A to the next calibration point, and start the calibration. Continue through all calibration points of Table 5-4
8. Set the 5500A to Standby, and continue at Section 5.6.7.

Table 5-5. DMM Gain Calibration Points

Cal step	UUT input value (5500A NORMAL)
CL 0840	500 mV
CL 0849	2.5 V
CL 0841	5 V
CL 0842	50 V (set 5500A to OPR!)
CL 0843	500 V
CL 0844	1000 V

5.6.7 Input A& B, and DMM Zero

Proceed as follows to do the Input A&B, and the DMM Zero calibration:

1. Press  to select calibration adjustment step CL0852
2. Short circuit Input A and Input B.

3. Short circuit the banana jack Meter inputs properly (calibration includes Ohms zero!).
4. Press  to start the zero calibration
5. Wait until the display shows the status **:READY**.
6. Remove the input terminations.
7. Continue at Section 5.6.8.

5.6.8 DMM Ohm Gain

Proceed as follows to do the DMM Ohm Gain calibration:

1. Press  to select first calibration adjustment step in Table 5-6.
2. Connect the test tool to the 5500A as shown in Figure 5-8.
Notice that the sense leads must be connected directly to the test tool.

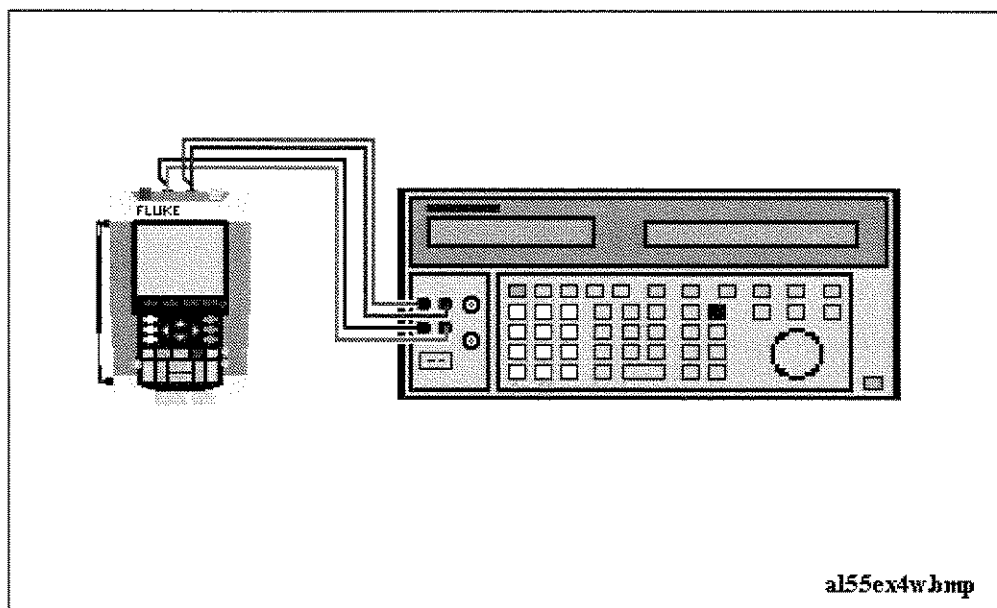

Figure 5-8. Four-wire Ohms calibration connections

al55ex4w.bmp





3. Set the 5500A to the first test point in Table 5-6. Use the 5500A “COMP 2 wire” mode for the calibration adjustments up to and including 100 k Ω . For the higher values, the 5500A will turn off the “COMP 2 wire” mode.
4. Set the 5500A to operate (OPR).
5. Press  to start the calibration.
6. Wait until the display shows the calibration status **:READY**.
7. Press  to select the next calibration step, set the 5500A to the next calibration point, and start the calibration. Continue through all calibration points.
8. When you are finished, set the 5500A to Standby.
9. Continue at Section 5.6.9.

Table 5-6. Ohm Gain Calibration Points

Cal Step	UUT input Value (5500 NORMAL)
CL 0910	100 Ω
CL 0911	1 kΩ
CL 0912	10 kΩ
CL 0913	100 kΩ
CL 0914	1 MΩ
CL 0915	10 MΩ

5.6.9 Calculate Gain

1. Remove all test leads from the test tool inputs.
2. Press  to select calibration adjustment step CL 0920.
3. Press  to start the calibration.
4. Wait until the display shows the calibration status :READY.
5. Continue at section 5.7

5.7 Save Calibration Data and Exit

Proceed as follows to save the calibration data, and to exit the Maintenance mode:

1. Remove all test leads from the test tool inputs.
2. Press  EXIT. The test tool will display:

**Calibration data valid.
Save data and exit maintenance mode?**

Note



Calibration data valid indicates that the calibration adjustment procedure is performed correctly. It does not necessarily mean that the test tool meets the characteristics listed in Chapter 2.

3. Press  YES to save and exit.

Note 1

After saving the calibration data, the calibration number and - date will be updated if the calibration data have been changed and the data are valid. The calibration number and - date will not change if:
- the calibration mode is entered and left without doing a calibration adjustment.
- only the contrast calibration adjustment (5.4) and/or the probe calibration is done.

Note 2

If you press  NO, the test tool returns to the calibration mode. You can either calibrate the test tool again, or press  EXIT,  YES to save and exit.

Possible error messages.

The following messages can be shown on the test tool display:

**WARNING: Calibration data not valid.
Save data and exit maintenance mode?**

Proceed as follows:

- If you did the WarmingUp and Pre-Calibration successfully (section 5.5), and you want to store the Pre-Calibration data before continuing with the Final Calibration:

Press  **YES.**

When turning the test tool off and on again, it will show the message:

**The instrument needs calibration.
Please contact your service center.**

The calibration date and number will not be updated. You must continue with the Final Calibration!

- To return to the Maintenance mode, if you want to repeat the complete calibration:

Press  **NO.**

Now press  until the display shows **WarmingUp (CL 0200):IDLE**, and calibrate the test tool, starting at section 5.5.

- If you want to exit and maintain the old calibration data:

Turn the test tool off.

5.8 Probe Calibration

To meet full user specifications, you need to adjust the supplied red and gray VPS200 voltage probes for optimal response.

To adjust the VPS200 probes, do the following:

1. Connect the red probe from the red Input A BNC to the banana jacks. See figure 5-9

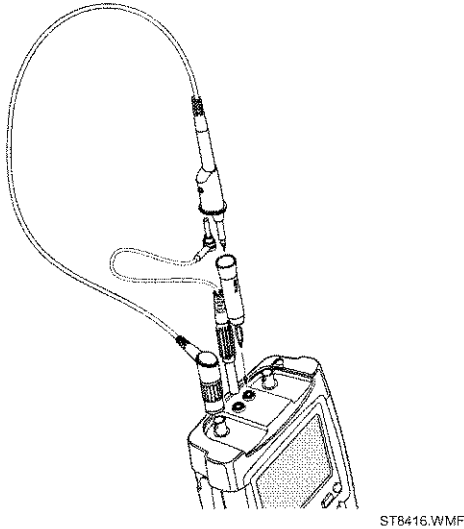

Figure 5-9. 10:1 Probe Calibration Connection

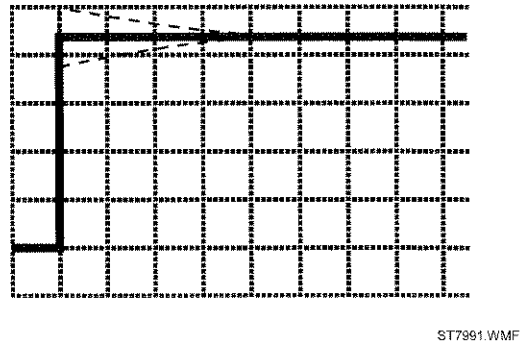





Figure 5-10. 10:1 Probe Calibration

2. Press , and then  to open the **Probe on A** menu
3. Select Probe Type: **■ Voltage | Attenuation: ■ 10:1 , ■ Probe Cal...**
4. Press  to start the probe calibration. A square wave appears on the screen. See Figure 5-10 (the lower half of the screen is covered with operating instructions).
5. Adjust the trimmer screw in the probe housing until a pure square wave is displayed.
6. Press  to continue with automatic dc calibration. The test tool automatically calibrates itself to the probe. A message indicates that the dc calibration has been completed successfully.
7. Repeat the procedure for the gray VPS200 probe, connected from the gray Input B BNC to the banana jacks.



Chapter 6

Disassembling the Test Tool

Title	Page
6.1. Introduction	6-3
6.2. Disassembly & Reassembly Procedures	6-3
6.2.1 Required Tools	6-3
6.2.2 Removing the Tilt Stand & Hang Strap.....	6-3
6.2.3 Replacing the Side-Strap, Changing the Side-Strap Position.....	6-3
6.2.4 Opening the Test Tool, Removing the Battery	6-3
6.2.5 Removing the Main PCA Unit and the Fan	6-5
6.2.6 Removing the Display Assembly.....	6-6
6.2.7 Replacing the LCD Window/Decal	6-7
6.2.8 Removing the Keypad and Keypad Foil.....	6-7
6.2.9 Disassembling the Main PCA Unit.....	6-7
6.2.10 Reassembling the Main PCA Unit.....	6-8
6.2.11 Reassembling the Test Tool	6-9



6.1. Introduction

This section provides the required disassembling procedures. The printed circuit assembly removed from the test tool must be adequately protected against damage.

Warning

To avoid electric shock, disconnect test leads, probes and power supply from any live source and from the test tool itself. Always remove the battery pack before completely disassembling the test tool. Only qualified personnel using customary precautions against electric shock should work on a disassembled unit with power on

6.2. Disassembly & Reassembly Procedures

6.2.1 Required Tools

To access all the assemblies, you need the following:

- Static-free work surface, and anti-static wrist wrap.
- #10 Torx screwdriver.
- Cotton gloves (to avoid contaminating the lens, and the PCA).

6.2.2 Removing the Tilt Stand & Hang Strap

Use the following procedure to remove the tilt stand and hang strap (Figure 6-5, item 15 and item 10).

1. Set the tilt stand to a 45-degree position respective to the test tool bottom.
2. The hinge consists of a circular raised rim in the tilt stand that is located over a circular lowering in the bottom case. Pull sideward on the front edge of the tilt stand until the hinge releases. Then rotate the stand to the rear to remove it. You can remove the hangstrap now.

6.2.3 Replacing the Side-Strap, Changing the Side-Strap Position

The side-strap (figure 6-5, item 15) can be attached at the right or left side of the test tool. Use the following procedure to replace the strap, or to change the strap position.

1. To remove the strap, unfold the strap ends (provided with Velcro tape), and pull the ends out of the strap holders (item 16).
2. To change the strap position open the test tool (see Section 6.2.4), remove the strap with the strap holders, attach them to the other side, and reassemble the test tool.

6.2.4 Opening the Test Tool, Removing the Battery

Use the following procedure to open the test tool, and to remove the battery:

1. Loosen the two M3 Torx screws that secure the input cover (Figure 6-1).
2. Loosen the two M3 Torx screws that secure the bottom holster (Figure 6-2).
3. Pull off the input cover and the bottom holster (Figure 6-3).

4. Unscrew the two screws that lock the bottom case.
5. Lift the bottom case at the lower side to remove it.
6. Lift out the battery pack (Figure 6-4).
7. Unplug the cable leading to the Main PCA (pull the cable gently backwards).

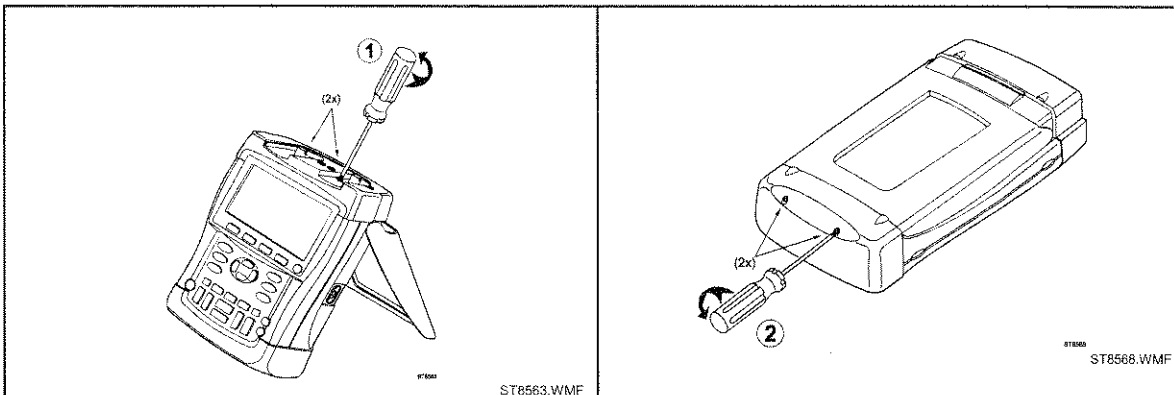

Figure 6-1. Loosen 2 Input Cover Screws

Figure 6-2. Loosen 2 Bottom Hoister Screws

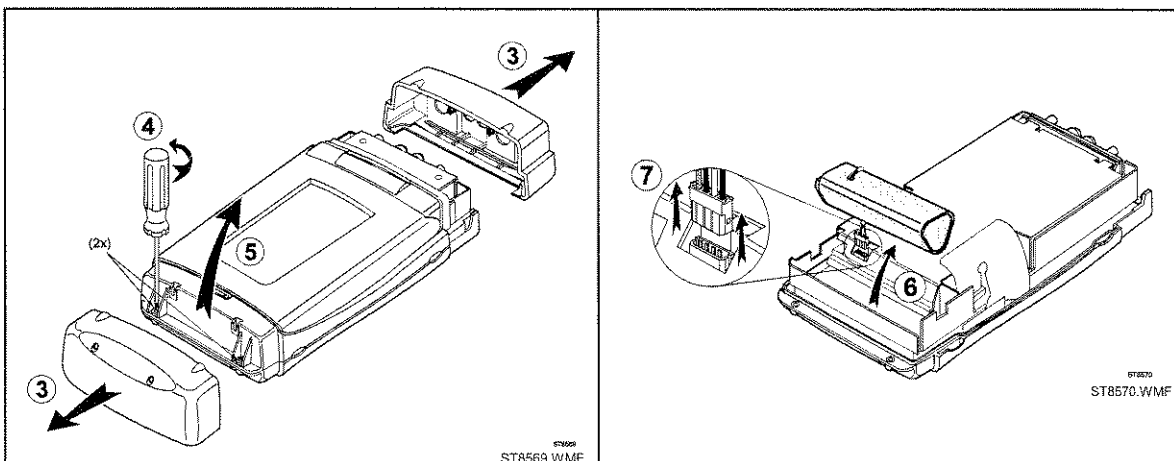

Figure 6-3. Opening the Test Tool

Figure 6-4. Removing the Battery Pack

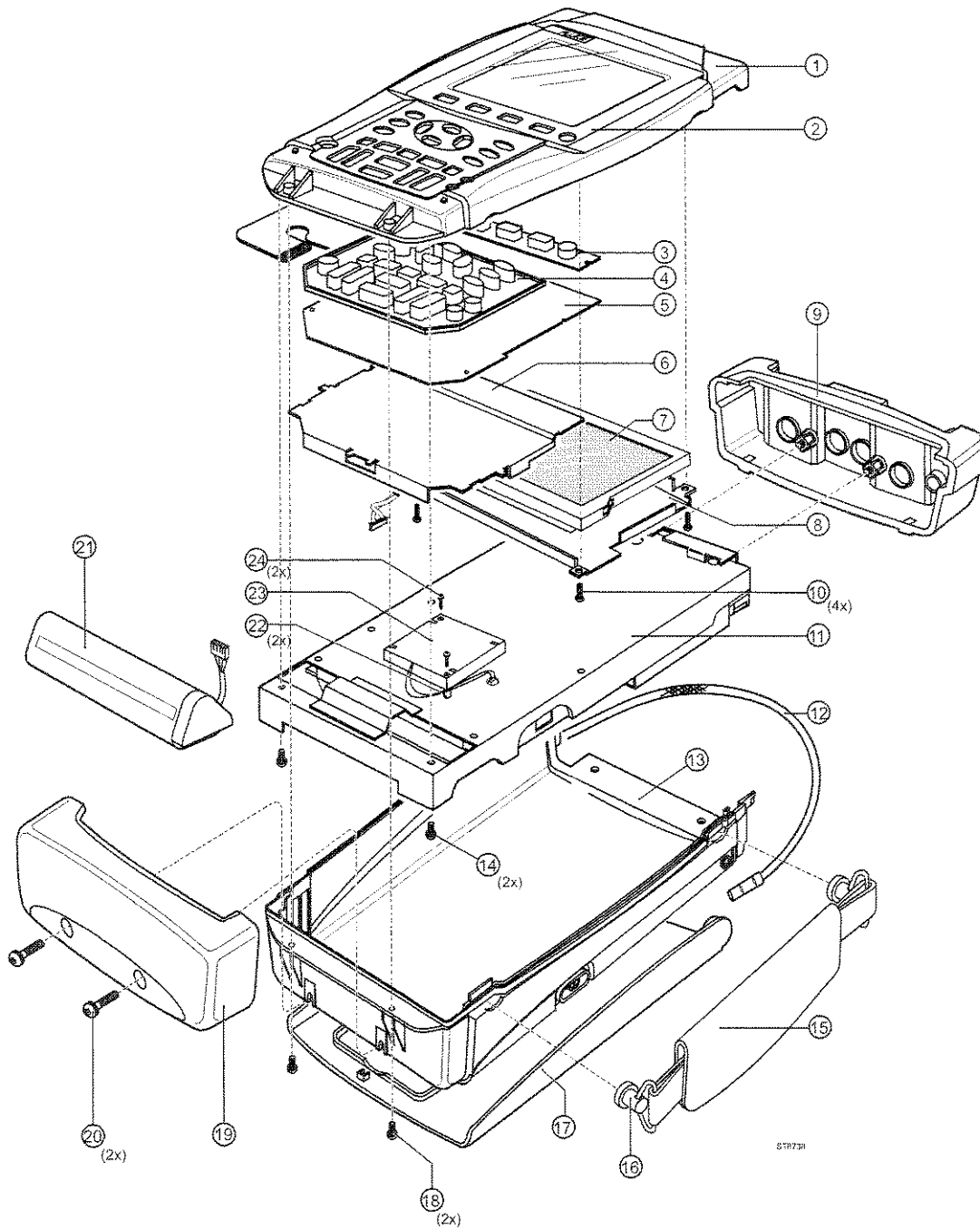

Figure 6-5. Final Assembly Details

ST8738.WMF

6.2.5 Removing the Main PCA Unit and the Fan

Caution

To avoid contaminating the flex cable contacts with oil from your fingers, do not touch the contacts (or wear gloves). Contaminated contacts may not cause immediate instrument failure in controlled environments. Failures typically show up when contaminated units are operated in humid areas.

Referring to Figure 6-5, use the following procedure to remove the main PCA unit.

1. Open the test tool (see Section 6.2.4).
2. Disconnect the blue keypad foil (item 5) flat cable, and the white LCD (item 7) flex cable. Unlock each cable by lifting the connector latch at the left and right edge using a small screw-driver, see Figure 6-6. The latch remains attached to the connector body.

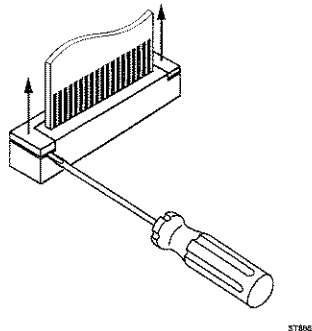

Figure 6-6. Flex Cable Connectors

ST8682.WMF

3. Unplug the two-wire backlight cable.

Warning

If the battery pack or the power adapter is connected, the LCD backlight voltage on the wire cable is 400V ! (when the test tool is on).

4. Remove the two screws (item 14) that secure the Main PCA unit to the top case.
5. Slide the Main PCA unit in the input cover direction to remove it.
6. To remove the fan from the main PCA unit, unplug the fan connector and unscrew the screws item 24.

6.2.6 Removing the Display Assembly

There are no serviceable parts in the display assembly. Referring to Figure 6-5, use the following procedure to remove the display assembly.

1. Remove the main PCA unit (see Section 6.2.5).
2. Unscrew the four screws item 10.
3. Remove the display assembly (item 7) with the mounting frame (item 8).
To prevent finger contamination, wear cotton gloves, or handle the display assembly by its edges.
4. Remove the display from the mounting frame.

6.2.7 Replacing the LCD Window/Decal

The LCD window/decal (Figure 6-5, item 2) is glued on the top cover. To replace it do the following:

1. From the inside of the top cover push the window outwards until it comes off.
2. Carefully remove remains of glue from the top cover. The bulk of the glue can be removed with sticky tape. This action must be completed by cleaning the surface with alcohol.
3. Remove the protection foil from the new window
4. Firmly press the new window on the top cover.

6.2.8 Removing the Keypad and Keypad Foil

Caution

To avoid contaminating the keypad contacts, and the keypad foil contacts with oil from your fingers, do not touch the contacts (or wear gloves). Contaminated contacts may not cause immediate instrument failure in controlled environments. Failures typically show up when contaminated units are operated in humid areas.

Referring to Figure 6-5, use the following procedure to remove the keypad and the keypad foil.

1. Remove the display assembly (see Section 6.2.6).
2. Remove the keypad support plate item 6.
3. Remove the keypad foil item 5. Notice the keypad foil positioning pins in the top case for reassembly.
4. Remove the keypads item 3 and item 4.

6.2.9 Disassembling the Main PCA Unit

Caution

To avoid contaminating the main PCA with oil from your fingers, do not touch the contacts (or wear gloves). A contaminated PCA may not cause immediate instrument failure in controlled environments. Failures typically show up when contaminated units are operated in humid areas.

Referring to Figure 6-7, use the following procedure disassemble the main PCA unit.

1. Unscrew the four M3x10 Torx screws (items 9) that secure the shielding cover (item 8), and remove the shielding cover.
2. Unscrew the M3x15 standoffs (item 10) that secure the PCA to the shielding box item 1.
3. Remove the PCA from the shielding box.
4. To remove the isolation strip pull one end out of the sleeves in the PCA (pull at points A). Then pull out the other end (pull at points B).

6.2.11 Reassembling the Test Tool

Reassembling the test tool is the reverse of disassembly. However you must follow special precautions when reassembling the test tool. Refer to figure 6-5.

Reassembling procedure for a completely disassembled unit:

1. Clean the inside of the lens with a moist soft cloth if necessary. Keep the lens free of dust and grease.
2. Install the keypads item 3 and item 4. Press the edges of the keypads into the sealing groove of the top case. Ensure that the keypads lay flat in the top case, and that all keys are correctly seated.
3. Install the keypad foil item 5. Align the positioning holes in the keypad foil to the positioning pins in the top case.
4. Install the keypad support plate item 6.
5. Clean the display glass with a moist soft cloth if necessary. Install the display assembly and its mounting frame, and fasten the 4 screws (item 10).
6. Verify that the fan cable connector is plugged into the Main PCA fan connector.
7. Slide the Main PCA unit into the Top Case from the display end. Make sure that the tabs on the Shielding Box go into the slots in the top of the Top Case. Fasten with the 2 screws (item 14).
8. Verify that the backlight wires are twisted to minimize interference voltages. Reattach the backlight cable. Reattach the LCD flex cable, secure that cable in the connector with the connector latch.
9. The keypad foil is provided with a grounded shielding flap that covers the backlight cable. This decreases the electromagnetic emission. The flap should cover the cable connection area and lay over the PCA shield. Reattach the keypad flex cable, secure the flat cable in the connector with the connector latch.
10. Install the battery pack, and re-attach the cable.
11. Install the bottom case with the strap holders and strap, and fasten the 2 screws item 18.
12. With the bottom cover up, start the screws (item 20) into the square nuts, then press in on the bottom holster to latch the tabs on the top case. Finish tightening the 2 screws.
13. Slide the input cover on and fasten with the 2 M3 Torx screws.
14. Calibrate the display contrast (see section 5.4) if you replaced the display.



Chapter 7

Corrective Maintenance

Title	Page
7.1 Introduction.....	7-3
7.2 Starting Fault Finding.....	7-4
7.3 Charger Circuit.....	7-5
7.4 Starting with a Dead Test Tool.....	7-7
7.4.1 Test Tool Completely Dead.....	7-7
7.4.2 Test Tool Software Does not Run.....	7-8
7.4.3 Software Runs, Test Tool not Operative.....	7-8
7.5 Miscellaneous Functions.....	7-8
7.5.1 Display and Back Light.....	7-8
7.5.2 Fly Back Converter.....	7-10
7.5.3 Slow ADC, +3V3SADC.....	7-11
7.5.4 Keyboard.....	7-12
7.5.5 Optical Port (Serial RS232 Interface).....	7-13
7.5.6 Channel A, Channel B Measurements.....	7-13
7.5.7 Meter Channel (Ext Trigger, Probe Cal).....	7-15
7.5.8 Input Signal Acquisition.....	7-17
7.5.9 ADC's.....	7-19
7.5.10 Digital Control & Memory.....	7-20
7.5.11 Buzzer Circuit.....	7-20
7.5.12 RAM Test.....	7-21
7.5.13 Power ON/OFF.....	7-22
7.5.14 Battery.....	7-22
7.6 Loading Software.....	7-23

7.1 Introduction

This chapter describes troubleshooting procedures that can be used to isolate problems with the test tool.

Warning

Opening the case may expose hazardous voltages. For example, the voltage for the LCD back light fluorescent lamp is >400V! Always disconnect the test tool from all voltage sources and remove the batteries before opening the case. If repair of the disassembled test tool under voltage is required, it shall be carried out only by qualified personnel using customary precautions against electric shock.

- If the test tool fails, first verify that you are operating it correctly by reviewing the operating instructions in the Users Manual.
- Use the following ground when making measurements for fault finding:
 - Input A input circuit, floating part (circuit diagram Figure 9-1): Red BNC common to PCA wire
 - Input B input circuit, floating part (circuit diagram Figure 9-2): Gray BNC common to PCA wire
 - Meter input circuit, floating part (circuit diagram Figure 9-3): Black banana to PCA wire
 - All other circuits (non floating): metal shield near the connectors, or the metal around the holes for the fastening screws
- To access the Main PCA for measurements, proceed as follows:
 1. Remove and disassemble the Main PCA unit, see Section 6.
 2. Connect the Display Assembly flat cable, the Backlight cable, and the Keypad Foil flex cable to the Main PCA unit. The test tool without the case is operative now. Figure 7-1 shows the operative opened test tool with removed metal shielding of the Channel B and of the Meter input circuit.
 3. Power the PCA via the Power Adapter and/or battery pack. Watch out for short-circuiting due to metal parts on your desk!

Caution

Do not power the unit when the LCD backlight cable is disconnected. The output voltage of the backlight voltage converter possibly can cause damage to the Main PCA when no load is connected for more than some minutes.

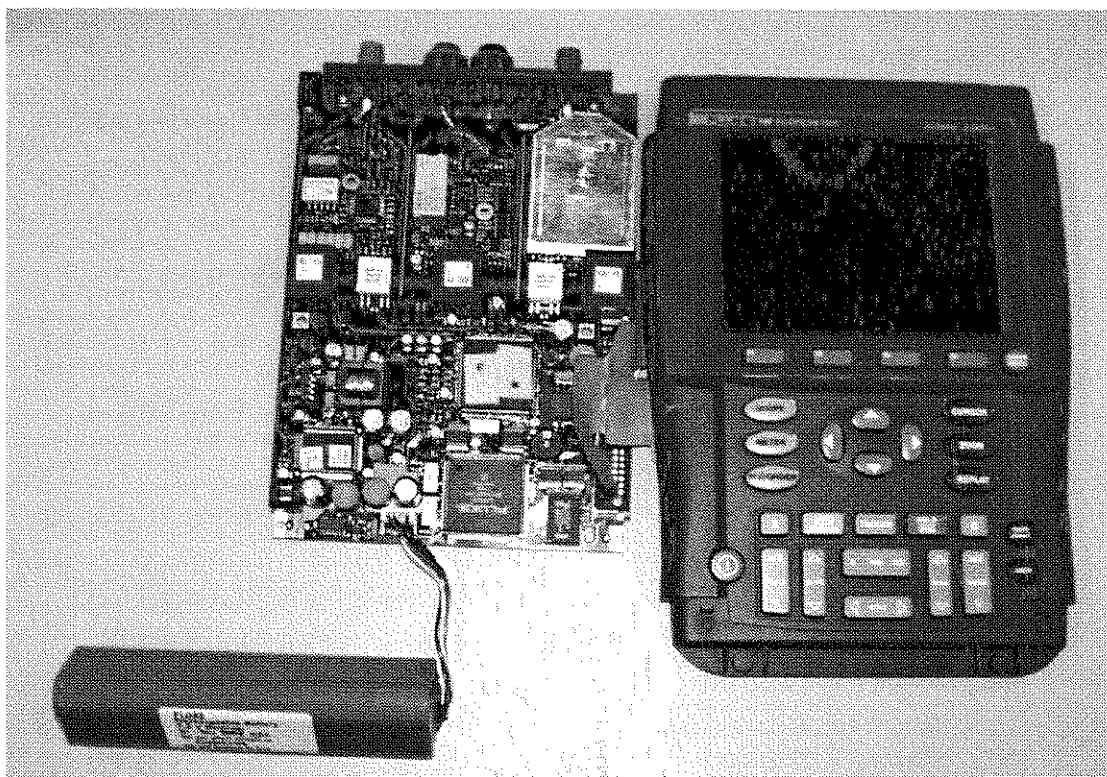

alf-open-256color.bmp

Figure 7-1. Operative Test Tool without Case

7.2 Starting Fault Finding.

After each step, continue with the next step, unless stated otherwise.

Power the test tool by the battery pack only, then by the power adapter only.

1. The test tool operates with the power adapter, but not with the battery only: install a charged battery (VBAT = 7.2 V nominal), and check the connections between the battery and the test tool (X4100, R4101).
2. The test tool operates with the battery pack, but not with the power adapter only, and the battery pack is not charged by the test tool: continue at 7.3 Charger Circuit.
3. The test tool operates neither with the battery pack, nor with the power adapter: continue at 7.4 Starting with a Dead Test Tool.
4. Particular functions are wrong: continue at 7.5 Miscellaneous Functions.

Table 7-1. Starting Fault Finding

	Power adapter	Battery Pack	Check
1	OK	NOT OK	Battery pack, connector, sense resistor
2	NOT OK	OK	See Section 7.3 Charger Circuit
3	NOT OK	NOT OK	See Section 7.4 Starting with a Dead Test Tool
4	Partly OK	Partly OK	See Section 7.5 Miscellaneous Functions

7.3 Charger Circuit

See circuit diagram Figure 9-9.

1. Power the test tool by the power adapter only. Do not switch on.
2. Check M4106 for 15...23 V; if wrong, check the power adapter input circuit.
3. Check VBAT (X4100:1) for about 11 V; if correct go to 4.
Check P-ASIC N4000:16 for a 13 V_{pp} (about 20 to 7 V) pulse signal (period 10...20 μs, some missing pulses allowed).
If wrong, check the charger circuit parts, and the connections to the P-ASIC N4000; replace N4000.
4. Connect a charged battery. VBAT (X4100: 1) must be now about 8 V.
5. Check P-ASIC N4000: 18 (P7VCHA) for $\cong 7V$.
If wrong, check N4000:20 for $\cong 19V$ (supplied via R4110). If 19V on pin 20 is not correct, check C4112, replace N4000.

P7VCHA is the supply voltage for the charger control circuit in N4000. It is derived from VADAPTER (pin 20), by an internal linear supply in P-ASIC N4000.

6. Check N4000:12 (NETVALD) for +2.7V, and M4101 (MAINVAL) for about +3V.
The MAINVAL signal indicates to the D-ASIC that a correct power adapter voltage is connected. The NETVALD and MAINVAL signal enable control of the P-ASIC CHARGE circuit (controls V4102 by 100 kHz, 13 V_{pp} square wave).

If correct continue at step 7.

If wrong, then:

- a. Check +3V3GAR (P-ASIC N4000:66) for +3.3 V.
If wrong, possibly caused by V4000, R4000, short to ground, loose pins of N4000, N4000 defective.
 - b. Check N4000:8 (VADALOW) for $\cong 1.6 V$
If wrong:
 1. Check R4120 and connections.
The P-ASIC supplies a current to R4120. The current source uses REFPWM2 and IREF, see 2 and 3 below.
 2. Check N4000:73 (REFPWM2, supplied by N4000) for +3V3. Check N4000:72 (REFP) for 1.2 V, check V4114 and connected parts.
 3. Check N4000:74 (IREF) for 1.6V.
If wrong, possibly caused by R4021, loose pin 74, or N4000 defective.
 - c. Check +3V3SADC on N4000:65 for about +3V. If not OK see section 7.5.3 +3V3SADC.
7. Check N4000:80 (CHARCURR):
The CHARCURR signal controls the battery charge current.
If < 2.7V continue at step 7a.
If > 2.7V continue at step 7b.

- a. Check if charger FET V4102 is controlled by a ≈ 100 kHz, 13 Vpp square wave (20 to 7 V) from P-ASIC N4000:16 (CHAGATE). If correct check V4102.
If wrong, check:

1. the voltage between N4000:4 and 9 for ≈ 140 mV. If wrong, check R4102, R4103 and connections.
2. the voltage between N4000:5 and 9 for $\approx 400\text{...}500$ mV for a battery temperature of about 20 °C. The voltage increases when the temperature rises. If wrong check the NTC in the battery pack for ≈ 10 k Ω at 20 °C (X4100 pins 3 and 2); check connections to N4000.
3. N4000:6 (IMAXCHA) for ≈ 400 mV. If wrong check R4114, and connections to N4000.
4. N4000:7 (VBATHHIGH) for ≈ 1.8 V. If wrong check R4113, and connections to N4000.

Steps 1 to 4 verify that N4000 supplies a 47 μ A current to each of the resistors R4102, battery NTC, R4113, R4114, and R4120.

5. Check N4000:9 for the same voltage as on M4105 (sense resistor R4101).
 6. If 1 to 5 above correct, then most probably N4000 is defective.
- b. Connect N4000:80 for a short time (max. 1 minute) to ground, and see if N4000:16 then shows a 100 kHz pulse signal.
If it does not, continue at step 7d.
If it does, the CHARCURR control signal is wrong, continue at step 7c.

- c. Check the CHARCURR control signal:

The CHARCURR voltage on N4000:80 is controlled by a pulse width modulated voltage (CHARCUR) from the D-ASIC D3500 (pin 40). The D-ASIC measures the required signals needed for control, via the Slow ADC (see circuit diagram Figure 9-10).



1. Check the SLOW ADC, see Section 7.5.3.
 2. Check VGARVAL (N4000:64), for +3.3V. If wrong, check if the line is shorted to ground. If it is not, then replace N4000.
 3. Trace the CHARCURR signal path to R4121, R3313 and D3500 (D-ASIC) output pin 40. Check the PWM output for 3.3 V pulses, see also 7.5.10.
- d. Check the following:
1. Parts and connections to N4000:10 and :11
 2. Connections between V4102 and N4000:16 (CHAGATE).
 3. The voltage at N4000:19, VCHDRIVE for $\approx 15\text{...}20$ V.
 4. The voltage at N4000:43 for a triangle wave form, 80...100 kHz, +1.6 V to +3.2 V.
 5. If 1 to 4 correct, then replace N4000.

7.4 Starting with a Dead Test Tool

If the test tool cannot be turned on, when powered by a charged battery pack, or by the power adapter, follow the steps below to locate the fault.

1. Connect a power adapter and a charged battery pack.
2. Turn the test tool on and listen if you hear a beep.
 - a. If you hear no beep, continue at 7.4.1 Test Tool Completely Dead.
 - b. If you hear a weak beep, continue at 7.4.2 Test Tool Software Does not Run.
 - c. If you hear a “normal” beep, the software runs, but obviously the test tool is not operative. Continue at 7.4.3 Software Runs, Test Tool not Operative.

7.4.1 Test Tool Completely Dead

1. Turn the test tool off. Keep the keys  and  pressed, and turn the test tool on again. This will start up the mask software.
If you still hear no beep, continue at step 2.
If you hear a weak beep now, continue at Section 7.4.2.
2. Check Keyboard ROW1 (MS3603 next to X3600) for a 3.3 V, 416.5 kHz signal.
To see the signal you must load the test point with 1 MΩ, for example connect it directly to a ScopeMeter input (no 10:1 probe!)
If wrong, continue at step 3.
If correct, the mask software runs, but the buzzer circuit does not function. Check the buzzer function (Section 7.5.10), and then continue at Section 7.4.2.
3. Check P-ASIC N4000:60 (VBATSUP) for >4.8V. If wrong check R4112, and connections to battery pack.
4. Check P-ASIC N4000:66 (+3V3GAR) for +3.3V.
If wrong, this is possibly caused by V4000, R4000, short to ground, loose pins of N4000, or N4000 defective. Check the supply voltages for the D-ASIC (+VD), ROM (+VDF), and RAM (+VDR1, +VDR2), derived from the +3V3GAR supply voltage.
5. Check P-ASIC N4000:64 (VGARVAL) for +3.3V. If wrong:
 - a. Check if the line is shorted to ground.
 - b. Check N4000:73 (REFPWM2, supplied by N4000) for +3.3 V. If not OK check N4000:72 (REFP) for 1.2 V, check V4114 and connected parts. If no 1.2 V, and parts and connections are correct, then replace N4000.
 - c. Check N4000:12 (NETVALID) for +2.6V. If wrong, proceed as indicated in Section 7.3, step 6.
 - d. Check the Power ON/OFF function, see Section 7.5.13.
6. Check X-tal signals on M3504 (32 kHz), M3506 (40 MHz), and M3505 (3.6864 MHz); if wrong check connections, replace X-tals, replace D3500. If the test tool is off AND not powered by the Battery Charger/Power Adapter, only the 32 kHz clock runs. If the 3.6864 MHz clock is present, then continue at Section 7.4.3.

7.4.2 Test Tool Software Does not Run.

1. Turn the test tool OFF and ON again.
2. Check Keyboard ROW1 (MS3603 next to X3600) for a 3.3 V, 416.5 kHz signal. *To see the signal you must load the test point with 1 M Ω , for example connect it directly to a ScopeMeter input (no 10:1 probe!)*
If not present, but you heard a weak beep, the test tool software runs, but the buzzer circuit does not function correctly. Go to Section 7.5.10 to check the buzzer circuit, then continue at Section 7.4.3 to see why the test tool cannot be operated.
If a 416.5 kHz signal is present, the MASK software runs. Continue at step 3.
3. Do the RAM test, see Section 7.5.12.
4. Load new software to see if the loaded software is corrupted. See Section 7.6.
5. Check for bad soldered address/data lines and IC pins.
6. Replace FlashROM/SRAM Module A1, and/or RAM D3502, D3503.

7.4.3 Software Runs, Test Tool not Operative

1. Check the Display and Backlight function, see Section 7.5.1
2. Check the Fly Back Converter, see Section 7.5.2
3. Check the Keyboard function, see Section 7.5.4.

7.5 Miscellaneous Functions

7.5.1 Display and Back Light



Warning

The voltage for the LCD back light fluorescent lamp is >250V!

See circuit diagram Figure 9-8 (LCD control) and 9-10 (Backlight control).

1. Connect another LCD unit to see if the problem is caused by the LCD unit. The unit is not repairable.
2. Check the LCD control signals on measurement spots MS3501...MS3522 (near to the LCD and keypad foil connectors). You can disconnect the backlight cable to get access to all measurement spots.

MS3501	+30V	+30V (from Fly Back Converter).
MS3504	REFPWM1	+3.3 V
MS3505	+3V45	+3.45 V
MS3506	+5V2	+5.2 V
MS3508	M_ENABL_C	pulses with 2.2 ms period
MS3509	+VD	+3.3 V
MS3510	FRAME_C	75 μ s pulses, period \approx 20 ms
MS3511	LINECLK_C	10 ns pulses, period 80 μ s
MS3513	LCDT0_C	pulses
MS3514	LCDT1_C	pulses
MS3516	LCDT2_C	pulses
MS3517	LCDT3_C	pulses
MS3519	DATACLK_C	pulse bursts with 80 μ s period

MS3520	GROUND	0 V
MS3521	LCDON_C	+5 V
MS3523	LCDT4_C	pulses
MS3524	LCDT5_C	pulses
MS3525	LCDT6_C	pulses
MS3526	LCDT7_C	pulses
MS3502	REFPWM2	+3.3 V
MS3507	P7VCHA	$\cong +7.5V$
MS3512	+2V6	2.6 V
MS3503	V0	+25 V *
MS3528	V1	+23.5 V *
MS3529	V2	+22 V *
MS3530	V3	+3.1 V *
MS3531	V4	+1.5 V *

* these voltages depend on the actual contrast setting. Their mutual relation should not change.

3. Bad contrast.
 - a. Check the voltage on R3604 (CONTRAST) for a voltage between +1 to +3.5 V, depending on the LCD contrast setting. Verify that the voltage changes if the contrast is changed.
If wrong check PWM circuit (Section 7.5.14).
 - b. Check the supply voltages V0...V4, see step 2.
4. Defective backlight (TL converter), see circuit diagram Figure 9-10:
The voltage at the hot side of the lamp (X4201:1) must be **350...400 Vrms**, 70 kHz .
 - a. Check VBAT on the battery connector pin 1 for >7 V
 - b. Turn the test tool on, and monitor the voltage on T4200:3 or 5 for a 12 Vpp, 70 kHz, half-rectified sine wave. If not present on both pin 3 and pin 5 continue, else go to step c. If a half rectified sine wave, with an increasing amplitude, is present for about 0.2 second directly after power on, then the secondary circuit is defective:
 - check the resistance between T4200:10 and 11 for $\cong 300\Omega$
 - check V4203, V4204.
 - install a new LCD unit.
 - c. Check T4200:3 and 5 for a 12 Vpp, 70 kHz, half-rectified sine wave. If it is present only on pin 3 or only on pin 5, then replace V4201.
 - d. Check M4200 and M4201 for a 10 Vpp, 70 kHz, square wave. If wrong then check M4203 (TLON) for +3V3. If TLON is correct, then replace N4200.
 - e. Check (replace) V4200, V4202.
 - f. Required voltages on other test points:
 - M4210 : 10 Vpp 140 kHz square wave.
 - M4211, M4212 : +1.5 Vdc.
 - M4213 : 12 Vpp rectified sine wave, 140 kHz (basic sine wave 70 kHz).
 - M4202 : 10 Vpp 140 kHz rectangular waveform, duty cycle about 30%.

5. Backlight brightness control wrong:
Check the M4203 (BACKBRIG, supplied by D-ASIC)
 - For low brightness: 20 kHz, 3.3 V pulses, pulse width 50 ns
 - For medium brightness: 20 kHz, 3.3 V pulses, pulse width 14 μ s
 - For high brightness: 20 kHz, 3.3 V pulses, pulse width 30 μ s
 Check M4212: +1.5 Vdc.
Check V4210, R4203.

7.5.2 Fly Back Converter

See circuit diagram Figure 9-9.

1. Check the fly back converter output voltages +5V2, +3V3GAR (+3.3 V), +3V45, +2V6, -1V8, -5V2 and +30V.
Check FLTPOWIN1 and FLTPOWIN2 (6.5Vrms, \approx 70 kHz) on for example T1102 pin 3 and pin 5
See the pictures below.

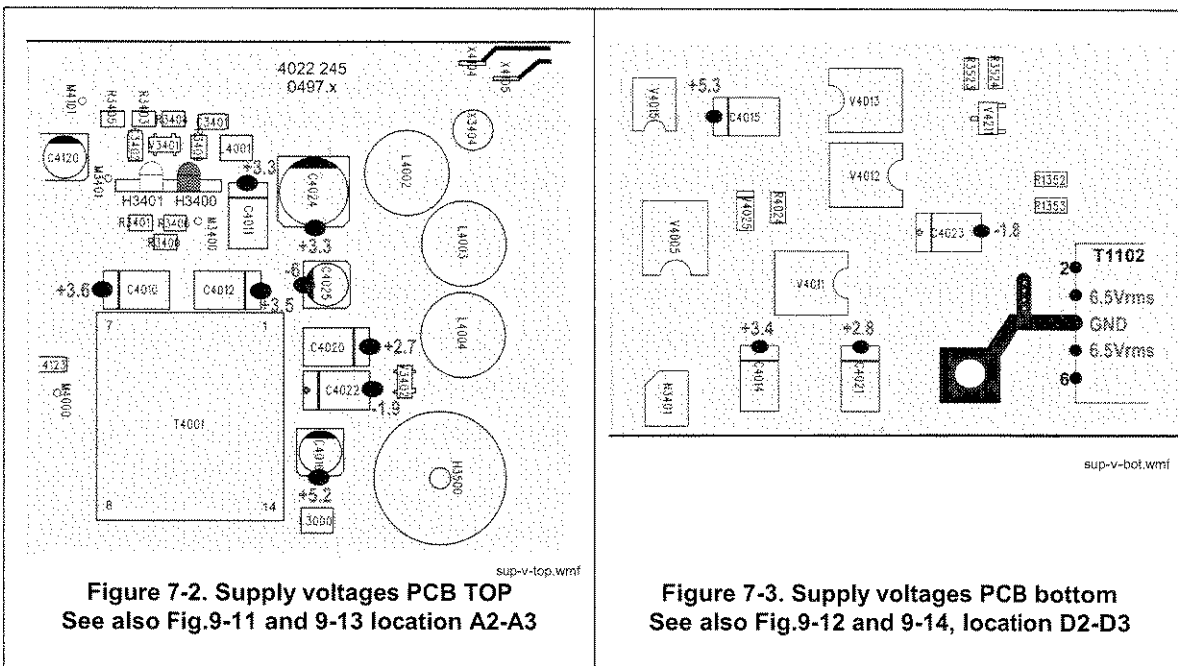

- a. If one or more voltages are correct, then check the rectifier diodes, coils, and capacitors of the incorrect voltage (s)
- b. If none of the voltages is correct, then the fly back converter does not run correctly, continue at step 2.
2. Check VBATT for >7 V.
3. Check N4000:49 (FLYGATE) for a square wave voltage of at least some volts (for a correct Fly Back Converter 50...100 kHz, \approx 8 Vpp).

If no square wave is present on N4000:49 go to step 4

If a square wave is present on pin 49 (maybe not the correct value), then check N4000:55 (FLYSENP) for a saw tooth voltage of 50...100 kHz, 300 mVpp.

- a. If **no** sawtooth voltage is present on N4000:55, no current or a DC current flows in FET V4001. The primary coil of T4001 or V4001 may be defective. Check also R4101 (current sense resistor); it can be fused due to a short in FET V4001.
- b. An **incorrect** sawtooth on N4000:55 can be caused by:
 - overloaded outputs (Frequency too low, $\ll 50$ kHz)
 - underloaded outputs (Frequency too high, $\gg 100$ kHz)
 - bad FET V4001 (Sawtooth voltage is not linear).
4. Check N4000:62 (PWRONOFF) for $>+3V$. If wrong, see Section 7.5.13 Power ON/OFF.
5. Check N4000:43 (COSC) for a triangle wave form, 50...100 kHz, +1.6 V to +3.2 V. If wrong check C4123 and connections; check IREF, see step 6. If all correct, then replace N4000.
6. Check N4000:74 (IREF) for 1.6 V. If wrong:
 - a. Check N4000:73 (REFPWM2) for +3V3. REFPWM2 is supplied by N4000, and derived from REFP. Check N4000:72 (REFP) for 1.22 V. If wrong, check V4114 and connected parts.
 - b. Check R4021, replace N4000.
7. Check N4000:51 (VOUTH1) for <2.5 V (nominal value 1.8 V). If wrong check R4014 and connections to N4000.
8. Check N4000:57 (IMAXFLY) for $\cong 570$ mV. If wrong check R4020 and connections to N4000.

7.5.3 Slow ADC, +3V3SADC

See circuit diagram Figure 9-10.

Check the following signals:

1. +3V3SADC (supplied by P-ASIC N4000:65) must be +3.3V. If the unit can be turned on and +3V3SADC is not OK, the line is shorted to ground or N4000 is defective.
2. BATCUR (D4300:12 from P-ASIC N4000:77), must be about $\{1.6+(6.7 \times IBATP)\}$ Volt. IBATP (N4000:9) senses the battery current. If wrong, replace N4000.
3. BATVOLT (D4300:14), must be $(0.3 \times VBAT)$ Volt. VBAT is the voltage on the battery connector X4100:1.
4. BATTEMP (D4300:15 from P-ASIC N4000:79), must be approximately the same as the voltage between battery connector X4100 pins 3 and 2, that is the voltage over the battery NTC. The voltage is about 350 mV at room temperature with opened ScopeMeter. N4000:5 sources 50 μA into NTC in battery pack. If the NTC voltage is ok, and BATTEMP is wrong, then replace N4000.
5. LCDCONTROL (D4300:5 from PTC V4205, must be about 1.8V at room temperature.
6. BATIDENT (D4300:13) senses an battery type identification resistor in the battery pack. Must be about 0 V.
7. REFADCT (D4300:1) must be 1.5 V

8. MBVRSIND (D4300:4) must be about 1 V. The voltage can be changed by installing different resistors R4301 and R4305 to identify a different Mainboard PCB version, see also Chapter 10 “Hardware modifications”.
9. Check the multiplexer control lines (from the D-ASIC)
 SELMUX0 (M4300): positive pulses, duty cycle 25%, period 1200 ms
 SELMUX1 (M4301): positive pulses, duty cycle 50%, period 600 ms
 SELMUX2 (M4302): positive pulses, duty cycle 25%, period 1200 ms
10. Check M4303. If the instrument is on, it must alternately show the voltage levels on D4300 pins 5, 12, 14, and 15; if at a fixed level, then replace D4300. When starting up, also the other inputs are sensed once.
11. Check M4304. In 300 ms the voltage levels successively approximate the values measured on M4303; if wrong, trace the signal to the PWM circuit on the Digital Control part (Figure 9-7).
12. Check M4305 for 3 V pulses with varying width; if at a fixed level then replace N4300.

7.5.4 Keyboard

Proceed as follows if one or more keys cannot be operated. Table 7-2 shows how the keys are connected to the rows and columns. For the ON/OFF key see Section 7.5.13.

Table 7-2. Test Tool Key Matrix

COL↓	ROW → test spot	0 MS3602	1 MS3603	2 MS3604	3 MS3605	4 MS3606	5 MS3607
0	MS3608						
1	MS3609						
2	MS3610						
3	MS3611						
4	MS3612						
5	MS3613						

1. Try a new keypad, and keypad foil to see if this cures the problem.
2. Press a key, and check ROW0...5 (measure spots MS3602..MS3607) for the signal shown below :

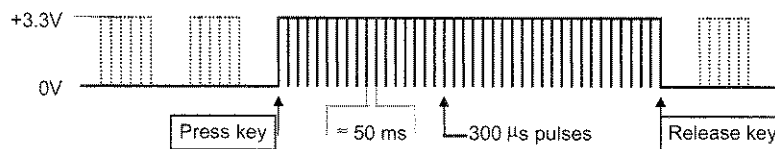

When a battery is installed, and no key is pressed the ROW lines are low.
When no battery is installed and no key is pressed (mains adapter supply), the ROW lines show 300 ms pulse bursts (dotted lines in the above figure).
During the time a key is pressed, the ROW lines show continuously pulses.

3. Check COL0...5 (measure spots MS3608...MS3613) for a +3.3V level. Then press and hold a key, and check the matching COL line for the signal shown below:

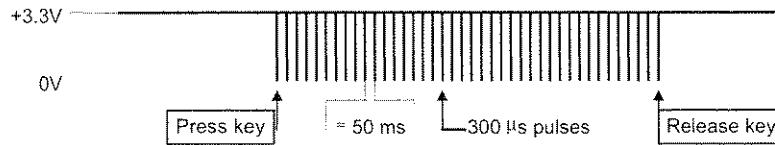

If wrong, check the connections from X3600 to D3500.



7.5.5 Optical Port (Serial RS232 Interface)

See circuit diagram Figure 9-10.

Receive (RXD1)

1. Check the voltage on M3401 for about +3.2 V
2. Check the voltage on N3401 pin 1 (measure for example on R3406):
dark: +3 V
light (shine with a lamp in the optical port H3401: 0 V.

Send (TXD1).

1. Check the voltage TXD on M3400 for +3.3V.
2. Press , and then press  PRINT to start the test tool print data output.
3. Check the line TXD on M3400 for a burst of pulses (pulses from +2.3 V to +3.3 V).
The length of the burst and the pulses depends on the selected baud rate.

7.5.6 Channel A, Channel B Measurements

See circuit diagram Figure 9-1 and 9-2.

When measuring in the input circuits of a the disassembled test tool, the backlight control voltage can cause noise on the measured signals. Do NOT power the unit when the backlight cable is disconnected!

1. Select SCOPE, and turn both channels on.
2. Apply a 200 kHz sine wave with a peak-to-peak value of 8 divisions to the inputs.
For example at 1 V/div apply 8 Vpp. Select manual ranging.
3. Check the S-ASIC output voltage for channel A on D3000 pin 5, and for channel B on D3100 pin 5. The voltage must be 1.2 Vpp (8 x 125 mV per division), on a +750 mV DC level. For time base settings of 2 μs/div and faster the measured frequency can alternately change from 200 kHz to 80 kHz.
4. Set the input signal frequency to 200 Hz (same amplitude) and repeat step 3 (check for 200 Hz). If steps 3 and 4 are OK, then check the ADC's etc., else continue with the next step.

The following tests are described for Channel A. Channel B can be tested in the same way, using similar test points.

1. Check the supply voltages on:
 - a. T1102:3 and 5 for a 50...100 kHz, 15 Vpp ac voltage (use the **non-floating** ground!)
 - b. T1102:9 and 5 for a 50...100 kHz, 15 Vpp ac voltage
T1102:10, and 12 for a 50...100 kHz, 12 Vpp ac voltage (use the **floating** ground!)
2. Check the HF path:
 - a. Apply a 200 kHz sine wave with a peak-to-peak value of 8*range to the inputs. For example at 1 V/div apply 8 Vpp.
 - b. Check the Channel A HF output voltage **between** T1100:6 (HFA1) and T1100:7 (HFA2), for a 300 mVpp sine wave; occasionally the sine wave can be interrupted for internal calibration measurements.
The voltage on T1100:6 and 7 w.r.t. ground is 150 mVpp on a 700 mV dc level
 - c. Check the Channel A HF signal **between** T1100:2 and 3 (supplied by C-ASIC N1200 pins 40-41) for 300 mVpp (150 mVpp on 3 Vdc on each pin referred to input ground!).
Check also M1021 and M1022 for the same voltage.
3. Check the LF path:
 - a. Apply a 200 Hz sine wave with a peak-to-peak value of 8*range to the inputs. For example at 1 V/div apply 8 Vpp.
 - b. Check C-ASIC N1000 output pin 30 on M1027 for a 800 mVpp sine wave on a 3 V dc level.
 - c. Check the channel A LF input of the S-ASIC N2001 on M1100 and on M1102 for a 200 Hz, 250 mVpp sine wave (signal has some HF noise). Use non-floating ground!
4. Check the control part:
 - a. M1030 (C-ASIC pin 23) and M1031 (C-ASIC pin 22) must show a 0.5 ... 5 ms pulse burst (+3.3 V to 0) when selecting another range. Periodically dynamic calibration will cause bursts to be shown if no key is pressed. Use floating input ground!
 - b. Measure on R1152 and R1153 for same pulse burst (2.4 to 0.8 V) as in a. Use the non-floating ground!
If wrong See 7.5.8, sub section **C-ASIC Control/Linearization Circuit**
5. Check the calibration line PWM (pin 21, M1018):
 - a. after power on the line supplies a 100 ms, +1.4 V reset pulse to the C-ASIC
 - b. during the calibration adjustment pre-calibration step CL 340 it provides a repetitive ramp (25 s period, 1.5 Vpp) for linearization. If the ramp is wrong, an error message will be generated at step CL 340.
6. If all OK the S-ASIC control probably does not function correctly, or the S-ASIC is defective: continue at Section 7.5.8. S-ASIC Control.

7.5.7 Meter Channel (Ext Trigger, Probe Cal)

See Circuit diagram Figure 9-3.

When measuring in the input circuits of a the disassembled test tool, the backlight control voltage can cause noise on the measured signals. Do NOT power the unit when the backlight cable is disconnected!

The Meter Channel and Channel B use the same S-ASIC output and ADC. If both channels fail, and Channel A is OK, then check the S-ASIC and ADC (section 7.5.9) first.

Table 7-3 shows the control line status for the various Meter Channel functions.

Table 7-3. Meter Channel Control Line Status

MODE	ATT0	ATT1	ATT2	GAIN0	GAIN1	I0	I1	I2	REL0	REL1	PRCALAC	SEL0	SEL1
D1570	4	5	6	7	14	13	12	11					
D1571									4,5	6,7	14	13	12
Volt 500mV	1	0				1	0	0	0	0	1		
Volt 5V	0	0				1	0	0	0	0	1		
Volt 50V	1	1				1	0	0	0	0	1		
Volt 500V	0	1				1	0	0	0	0	1		
Volt 1000V	0	1		1		1	0	0	0	0	1		
500 Ohm	0	1	0	1		0	0	0	0	0	1		
5K Ohm	0	1	0	1		1	0	0	0	0	1		
50K Ohm	0	1	0	1		0	1	0	0	0	1		
500K Ohm	0	1	0	1		1	1	0	0	0	1		
5M Ohm	0	1	0	1		0	0	1	0	0	1		
30M	0	1	0	1		0	0	1	0	0	1		
Trig Ext 120 mV	1	0	1	0	1	1	0	0	0	0	1	0	0
Trig Ext 1.2 V	0	0	1	0	1	1	0	0	0	0	1	1	0
Probe Cal DC	*	*	*	*	*	*	*	*	*	*	1	*	*
Probe Cal AC	*	*	*	*	*	*	*	*	*	*	0	*	*
Diode	0	1	0	1	1	0	0	0	0	0	1		
K1500 set to VOLT									0				
K1500 set to OHM										0			

Volts function.

1. Select METER (), MEASURE (), V ac+dc.
2. Select manual ranging.
3. Apply a positive dc voltage of 50% full scale to the input.
4. Check D1501:3 for a -60 mV voltage level, interrupted by reference level pulses: - +220 mV, each 2.5 seconds from D1501:13; zero, each 400 ms from D1501:12.

5. Check N1501:7 for a -120 mV voltage level (gain N1501 is x2), interrupted by reference level pulses:
- +220 mV and -240 mV, each 2.5 seconds ; zero, each 400 ms
6. Check N1525:5 : the voltage levels must be 0.33x the levels measured in step 5.
7. Check N1525:7 for a +2.6 V level with reference level pulse sequence as in step 6.
8. Check N1525:1 for a +300 mV level with reference level pulse sequence as in step 6.
9. Check the H1525 diodes, resistors R1528-R1533, and connections to S-ASIC.
10. If all OK the S-ASIC control probably does not function correctly, or the S-ASIC is defective: continue at Section 7.5.8. S-ASIC Control.

Ohms function





1. Verify the Volts function, if OK continue below, else check the Volts function first
2. Select the Ohm function, manual ranging.
3. Connect a dc ampere meter between the banana jack inputs. Check the currents ($\pm 20\%$) supplied by the current source for all ranges:

range	500 Ω	5 k Ω	50 k Ω	500 k Ω	5 M Ω	30 M Ω
current	0.5 mA	50 μ A	5 μ A	0.5 μ A	50 nA	50 nA
I0	0	1	0	1	0	0
I1	0	0	1	1	0	0
I2	0	0	0	0	1	1

- a. If all wrong check the connection from X1000 to FET V1560, V1560, N1540 and connected parts, check N1541:1 for +3 V, check the V1536 emitter, base, and collector for the same voltage.
- b. If one or more currents OK then check D1560 and control signals I0, I1, I2.
4. Apply a resistor of 50% of full scale (e.g. 250 Ω in the 500 Ω range) to the input.
5. Check N1501:1 for about +110 mV (narrow spikes are allowed).
6. Check D1501:3 for 100 mV dc, interrupted by reference level pulses:
- +220 mV, each 2.5 seconds ; zero, each 400 ms
7. Select the 30 M Ω range, remove the input resistor (open input).
8. Check D1501:3 for a +280 mV level (input voltage attenuated by R1547-R1548) interrupted by reference level pulses:
- +220 mV, each 2.5 seconds ; zero, each 400 ms
9. Check N1501:7 for a +80 mV level interrupted by reference levels:
- +220 mV, each 2.5 seconds; -250 mV, each 400 ms

External trigger function

The external trigger path uses the Volts 500 mV and 5 V range circuit.

1. Select SCOPE (), Trigger menu (), Trig Ext (), Ext LEVEL 0.12 V ().
2. Apply a 100 Hz, 0 to +0.5 V square wave to the banana jack inputs.
3. Check D1501:3 for a 0 to -125 mV square wave.

4. Check N1501:7 for a 0 to -750 mV square wave. The N1501 gain is set to 6x via D1502:3 to 15, and $(R1508+R1510+R1512)/R1512$.
5. Select Ext LEVEL 1.2 V, and apply a 100 Hz, 0 to +5 V square wave to the inputs.
6. Do step 3 and step 4.
7. Remove the input signal.

Probe Cal function

1. Select SCOPE (), Input a menu (), probe A (), Probe Cal + ENTER, Yes ()
2. Check D1500:13 for a \approx 500 Hz, 0 to +3 V square wave.
If OK, check signal path to red banana input X1000, else continue at 3.
3. Check D1500:10 for a 500 Hz 0 to +5 V square wave, and D1500:9 for 0 V.
4. Check the 0.5 mA current source used for dc probe cal, see Ohms.
5. Check D1571:14 for a low level. Now press Continue to start the 10:1 probe dc calibration, and verify that the PRCALAC line at V1545 pin goes high. Probe dc calibration can only be done if probe 10:1 has been selected.

Control signals

Control signals are supplied by the D-ASIC (D3500:P1 and P2) via the SCLKEXT and SDATEXT lines.

1. Select the Ohms or Volts function.
2. Check D1570:1 for 1.5 ms positive pulses
3. Check D1570:2 and 3 for positive pulses.
4. Check D1571 pin 2 for positive pulses.
5. Using Table 7-3 at the beginning of this section to verify the control line voltage levels for the various functions.

3V Clamp, Protection

1. Check N1541:1 for +3V
2. Select Ohms, manual ranging, 500 Ω , and check N1540 pin 1:
 - open input, about +3.6 V
 - shorted input, about +0.5 V.

7.5.8 Input Signal Acquisition

See circuit diagram Figure 9-4 and 9-5.







Supply voltages

Check the S-ASIC supply voltages, see circuit diagram Figure 9-5.

C-ASIC Control/Linearization Circuit

If the circuit is defective, an error can occur during calibration (pre-cal linearization step CL340, 341, 345), or the input C-ASIC's cannot be controlled (e.g. no ranging).

1. Select SCOPE mode and check D2000:

- a. pin 9-10-11: LOW
 - b. pin 12 (= M3502 SDAT) and pin 14: HIGH; a pulse burst (about 700 μ s) must be seen when e.g. selecting another range in SCOPE mode.
2. If linearization fails during calibration, then select calibration mode ( + ).
- a. Press  (NEXT), and then  (PREVIOUS) a number of times until you see Lin 20 MS A (CL 0340): IDLE (valid) or (invalid).
Press  CALIBRATE and check D2000:9,10,11 for a HIGH level
Check D2000:13 and 14 for a 5 kHz square wave with changing duty cycle.
If OK trace the signal to M1031 (pin 22 of the C-ASIC N1000).
If still OK check M1018 (Channel A circuit) for repetitive ramp voltages.
 - b. Repeat step a. for calibration step LIN MS B (CL341), and trace same signals to the Channel B circuit.
 - c. Select calibration step Lin 20 MS E (CL 345).
Press  CALIBRATE and check D2000:9,10,11 for a HIGH level.
Check D2000:4 for a very low frequency (period 50 s) sawtooth voltage (+1.6 V to -0.8 V).
D2000:1 and 15 must show a 5 kHz square wave with changing duty cycle.

S-ASIC Control

1. Check the DATA lines, ADDRESS lines, and control lines (pin 13) on D2001 and D2002 for pulses.
2. Check D2003 and D2004

D2003: 1	pulses	D2004: 1	high
2	pulses	2	pulses
3	pulses	3	pulses
4	pulses	4	high
5	pulses	5	pulses
6	pulses	6	pulses
7	low	7	low
8	pulses	8	pulses
9	pulses	9	high
10	low	10	pulses
11	pulses	11	high; at power off: 
12	pulses	12	high
13	low	13	high
14	high	14	high
3. Check N2001:

8	INTRP	M2006	pulses if time base 2 μ s/div or faster, else high
84	TRIGLEV4	M2010	500 mV
85	TRIGLEV3	M2011	500 mV
86	TRIGLEV2	M2012	200...600 mV when moving trigger level
87	TRIGLEV1	M2013	200...600 mV when moving trigger level
109	EXTACQHO		500 mV pulses; 5 V pulses on HOLDOFF R2028
123	TRIGDT	M2000	select "EDGE triggering - Wait for trigger", apply input signal that must cause triggering : 3V pulses if trace must be updated, else low
124	ALLTRIG	M2001	3V pulse each time input signal crosses trigger level

127	EXTTRIG	M2001	3V pulse each time input signal crosses trigger level
129	RSRMPCLM		0.5 V (on RSTRAMP 5 V) positive pulses
131	RMPCLCML		0.5 V (on RAMPCLK 5 V) low pulses with noise
133	ADCCLCML		Clock pulses 0.5 V (CLKJILL 5 V), in SCOPE mode 20 MHz; in METER mode 4 MHz.
137	XOSCBUF	M2008	25 MHz 0.4 V pp (X-tal B2000) on 1.8 V dc
138	XOSCIN		25 MHz 0.4 V pp (X-tal B2000) on 1.8 V dc
152	IREF1		+1.4 V
155	MIDADC		+0.7 V (from ADC D3000)
156	REFPWM		+3.3 V
157	REFADCTOP	M2053	+1.4 V

4. Check the QUALIFIER EXTENDER circuit (Figure 9-5):
 Select Scope, Trigger Options (press TRIGGER), Pulse Width on A, Pulses \bar{L} , Condition <t, Update On Trigger. Select WIDTH (softkey F1) and set to 300 ns. Apply a 5 MHz square wave to Input A (pulse width is 100 ns).
 Check:
 - M3201 , M3202: high with 10...50 ns low pulses
 - M2001 (ALLTRIG): 5 MHz "square" wave
 - D3203 pin 10 (ENSHPULS): low
5. Check VIDEO SYNC SEPARATOR N2020 signals
 Select Video Triggering, and apply a video signal to the Input A

N2020 pin 1	+3.3 V with 250 μ s low pulses (60 Hz at NTSC)
2	+3.3 V with 5 μ s low pulses 1.5 Vpp (15.7 kHz at NTSC)
3	+5V with 250 μ s low pulses (60 Hz at NTSC)
6	+1.2 V
7	square wave 2 Vpp (30 Hz at NTSC)

7.5.9 ADC's

See circuit diagram Figure 9-6.

Check the following signals on D3000 and D3001 (SCOPE, A&B on):

OLD MAIN PCA:

- pin 14-21 3 V pulses
- pin 5 \approx 125 mV per division trace amplitude; +0.7 V for zero trace.
- pin 6 +3.45 V
- pin 7 +1.7V
- pin 8 +1.4 V
- pin 9 +0.7 V (only for D3000:9)
- pin 24 D3000 SCOPE mode input A on: 20 MHz, 3 Vpp clock
- pin 24 D3100 SCOPE mode input B on: 20 MHz, 3 Vpp clock
 METER mode: 4 MHz, 3 Vpp-clock; occasionally 20 MHz clock bursts.

NEW MAIN PCA

- pin 5-12 for activity (3 V pulses)
- pin 27 \approx 125 mV per division trace amplitude; +0.7 V for zero trace.
- pin 2, 28 +3V45
- pin 21 +1.4 V; check M3003 for +0.7 V
- pin 15 D3000 SCOPE mode input A on: 20 MHz, 3 Vpp clock
- pin 15 D3100 SCOPE mode input B on: 20 MHz, 3 Vpp clock
METER mode: 4 MHz, 3 Vpp-clock; occasionally
20 MHz clock bursts.

7.5.10 Digital Control & Memory

See circuit diagram Figure 9-7.

Check the following:

1. +3V3GAR and derived voltages +VD, +VDF, +VDR2 for +3.3 V.
2. Do the RAM test, see 7.5.12
3. Replace FlashROM/SRAM module A1

Check D3550:

Power the test tool by the battery only, and switch it on. Check:

- D3550: 34 +3.3 V; when the test tool is switched off a 60 μ s low pulse
- 35 +0.3 V; when the test tool is switched off a 60 μ s high pulse
- 38 32 kHz, 3.3 Vclock
- 39 +3.3 V; when the test tool is off 0 V
- 40 40 MHz, 3.3 V clock; when the test tool is off +2.6 V
- 43 +3.3 V

D3550 ensures that the supply current for the D-ASIC D3500 is limited to about 0.8 mA when the test tool is off, while powered by the battery only. If D3550 is defective the current can be 8 mA, and will discharge the battery in about two weeks.

Check D3507 (Watchdog)

- pin 1 must be + 3.3 V
- pin 4 power on/off with power adapter, or power on with battery only: 33 Hz, +3.3 V pulses
power off with battery only or mask mode: 1 Hz, +1.5 V pulses

7.5.11 Buzzer Circuit

See circuit diagram Figure 9-7.



1. Select METER mode, Measure Continuity
2. Short circuit the Meter Input banana jacks. The buzzer is activated now.
3. Check M3500 for a 4 kHz, 0...3V square wave during beeping (+3 V if not activated).
If the +30V is not present you will hear a weak beep. This happens if only the mask software is running.

7.5.12 RAM Test

You can use the Microsoft Windows Terminal program or MetCal to test the RAM.

To use the Microsoft Windows Terminal proceed as follows:

1. Connect the Test Tool to a PC via the Optical Interface Cable PM9080.
2. Start the Terminal program, and select the following Settings:

Terminal Emulation	TTY (Generic)	
Terminal Preferences	Terminal Modes	CR -> CR/LF
	<input checked="" type="checkbox"/> Line Wrap	<input checked="" type="checkbox"/> Inbound
	<input checked="" type="checkbox"/> Local Echo	<input type="checkbox"/> Outbound
	<input checked="" type="checkbox"/> Sound	
Communications	Baud Rate	9600
	Data Bits	8
	Stop Bits	1
	Parity	None
	Flow Control	Xon/Xoff
	Connector	COMn
3. Turn the test tool off. Keep the keys  +  pressed, and turn the test tool on again. This will start up the mask software. You will hear a very weak beep now.
4. In the terminal program type capital characters X (no ENTER!). After a number of characters the test tool mask software will respond with an acknowledge 0 (zero). This indicates that the communication between the Terminal program and the test tool is accomplished.
5. Type ID and press [Enter]
The test tool will return an acknowledge 0 (zero), and the string
Universal Host Mask software; UHM V3.0
If it does not, check the Terminal program settings, the interface connection, and the test tool Optical Port (Section 7.5.5).
6. To test D3502+D3503:
Type EX11, #H20400000, #H100000 (for the OLD Main PCA)
or
EX11, #H20400000, #H80000 (for the NEW Main PCA D3202 only)
and press [Enter]
The test tool will return one of the following acknowledges:
0 RAM is OK.
1 syntax error in the typed command
6 the RAM does not properly function, replace one or two RAMs.
7. To test the RAM on the FlashROM/SRAM module A1:
Type WW10000000,2,00020002 and press [Enter]
The test tool must return acknowledge 0 (zero)

Type EX12, #H44000000, #H100000 and press [Enter]
The test tool will return one of the following acknowledges:
0 RAM is OK.
1 syntax error in the typed command
6 the RAM does not properly function, replace the A1 module.

Note:

On the Terminal Screen, the ScopeMeter acknowledge overwrites the first character of the message that has been sent to the test tool.

You can use the following MetCal program to do the test:

```
1.001 PORT      [P1200,n,8,1,x]
1.002 PORT      em[13] [i]
1.003 PORT      FLUKEUHM[13] [i]
1.004 PORT      [d2000]
1.005 PORT      XXXXXXXXXXX[i]
1.006 PORT      id[13] [i] [i$]
1.007 LABEL     repeat
1.008 PORT      [i$]
1.009 JMWL      repeat ZCMPI(mem2,"0")
1.010 PORT      ex11,#H20400000,#H100000[13] [i] (OLD Main PCA)
                  ex11,#H20400000,#H80000[13] [i] (NEW Main PCA)
1.011 JMWL      error1 mem > 0
1.012 DISP      RAM D3502, D3503 ok
1.013 PORT      WW10000000,2,0002,0002[13] [1]
1.014 PORT      EX12,#H44000000,#H100000[13] [i]
1.015 JMWL      error2 mem > 0
1.016 DISP      A1 module ok
1.017 JMWL      stop
1.018 LABEL     error1
1.019 DISP      RAM D3502 or D3503 defective
1.020 JMWL      stop
1.021 LABEL     error2
1.022 DISP      RAM on A1 module defective
1.023 LABEL     stop
1.024 END
```

7.5.13 Power ON/OFF

Check MS3614 for +3 V (supplied by D3500:F4). If the ON key is pressed, MS3614 must go low.

If wrong, do the Section 7.4.1. tests first!

7.5.14 Battery

Battery operating time is does not meet the specification (4 hours):

1. Turn the ScopeMeter on (battery power only)
2. Check the voltage across R4101 (near the battery connector) for about 140 mV. This corresponds to a current of about 0.95 A. If the current is much higher the cause of the problem is not the battery.

Battery is discharged when ScopeMeter is not used for some time (2 or 3 weeks)

1. Turn the ScopeMeter on (battery power only)
2. Check the voltage across R4101 (near the battery connector) for about 0.15 mV. This corresponds to a current of about 1 mA. Turn the ScopeMeter off and on, and check the voltage again for 0.15 mV. Do this about 10 times.
If one or more times a current of about 1.2 mV is measured (8 mA), the cause is a defective IC D3550. This IC takes care of a correct power state of D3500.
As the 8 mA discharge current can have damaged the battery, you must check the battery capacity as described below.
3. If the current is much higher then 8 mA the cause of the problem is not or is not only D3550 .

To check if the battery has a correct capacity:

1. Do a battery refresh : USER, OPTIONS..., Battery Refresh

2. Disconnect the BC190 Battery Charger/Power Adapter
3. Start a TrendPlot: RECORDER
4. When the battery is discharged the ScopeMeter will shut down. Now connect the BC190, turn the power on and check the length of the TrendPlot trace. For a new battery pack this should be about 4 hours. Depending on the number of applied charge cycles the battery capacity will decrease. If the TrendPlot trace has a length of 3 hours or less you may consider to replace the battery pack.

7.6 Loading Software

To load a new software version in the test tool contact an authorized Fluke Service center, see section 8.3.



Chapter 8

List of Replaceable Parts

Title	Page
8.1 Introduction.....	8-3
8.2 How to Obtain Parts.....	8-3
8.3 Service Centers.....	8-3
8.4 Final Assembly Parts.....	8-4
8.5 Main PCA Unit Parts.....	8-6
8.6 Main PCA Parts.....	8-8
8.7 Accessories.....	8-30

8.1 Introduction

This chapter contains an illustrated list of replaceable parts for the models 192B, 196B, 196C, 199B and 199C ScopeMeter test tool. Parts are listed by assembly; alphabetized by item number or reference designator. Each assembly is accompanied by an illustration showing the location of each part and its item number or reference designator. The parts list gives the following information:

- Item number or reference designator (for example, “R122”)
- An indication if the part is subject to static discharge: the * symbol
- Description
- Ordering code

Caution

A * symbol indicates a device that may be damaged by static discharge.

8.2 How to Obtain Parts

Contact an authorized Fluke service center, see section 8.3.

To locate an authorized service center refer to the second page of this manual (back of the title page).

In the event that the part ordered has been replaced by a new or improved part, the replacement will be accompanied by an explanatory note and installation instructions, if necessary.

To ensure prompt delivery of the correct part, include the following information when you place an order:

- Instrument model (for example Fluke-196C), 12 digit instrument code (9444), and serial number (DM.....). The items are printed on the type plate on the bottom cover.
- Ordering code
- Item number - Reference designator
- Description
- Quantity

8.3 Service Centers

To locate an authorized service center, call Fluke using any of the phone numbers listed below, or visit on the World Wide Web: www.fluke.com

USA and Canada: 1-888-99-FLUKE (1-888-993-5853)

Europe: +31-40-2675-200

Japan: +81-3-3434-0181

Singapore: +65-738-5655

Anywhere in the world: +1-425-446-5500

8.4 Final Assembly Parts

See Table 8-1 and Figure 8-1 for the Final Assembly parts.

Table 8-1. Final Assembly Parts

Item	Description	Ordering Code
1	Top case assembly Fluke 192B, 196B, 196C, 199B, 199C (without LCD, without window/decal)	4022 244 98391
2	Display window/decal Fluke 192B	4022 240 12501
	Display window/decal Fluke 196B	4022 240 12511
	Display window/decal Fluke 196C	4022 240 12541
	Display window/decal Fluke 199B	4022 240 12521
	Display window/decal Fluke 199C	4022 240 12551
3 + 4	Keypad set (includes large & small keypad)	4022 243 09762
5	Keypad foil	4022 245 04962
6	Keypad support assembly	4022 244 98401
7	Display unit Color Fluke 196C, 199C	4022 244 93261
	Display unit B/W Fluke 192B, 196B, 199B	4022 244 93271
	The Display unit does not include the flat cable	
	Flat cable for display unit (both versions)	4022 303 40111
8	Display mounting frame assy	4022 244 98421
9	Input cover (including screws)	4022 244 98121
10	EJOT Pt screw	4022 244 92551
11	Main PCA unit for all models. Unit is provided with sticker 190B/C (see note 1 below) On delivery the Fluke 199C testsoftware is loaded! Load appropriate software and type number, then always calibrate the unit! See Section 10.4 for more information.	4022 244 98481
12	Hang strap	4022 244 98321
13	Bottom case assembly (see note 2 below)	4022 244 98131
14	Combi-screw Torx M3x10 (screw + split spring)	4022 325 42101
15	Strap	4022 244 98191
16	Strap holder	4022 244 98201
17	Tilt stand (bail)	4022 244 98211
18	Combi-screw Torx M3x10 (screw + flat washer)	4022 244 91231
19	Bottom holster	4022 244 98221
20	Combi-screw Torx M3x10 (screw + flat washer)	4022 244 91231
21	Battery Pack (see note 3 below)	BP190
22	Spacer M2.5x3 for Fan	4022 244 94701
23	Fan Assy	4022 246 19631
24	Screw M2.5x12, countersunk Torx for Fan	2522 203 04016

Note 1

Units with sticker 190C (4022 244 98411) will become obsolete. These units can be used for the Fluke 196C and 199C only. They can be provided with the newest software version.

Note 2

Do not use the old version bottom case assembly of the Fluke 192-196-199! See Figure 8-2 and Figure 8-3.

Note 3



The test tool contains a NiMH battery (item 21). Do not mix with the solid wastestream. Spent batteries should be disposed of by a qualified recycler or hazardous materials handler.

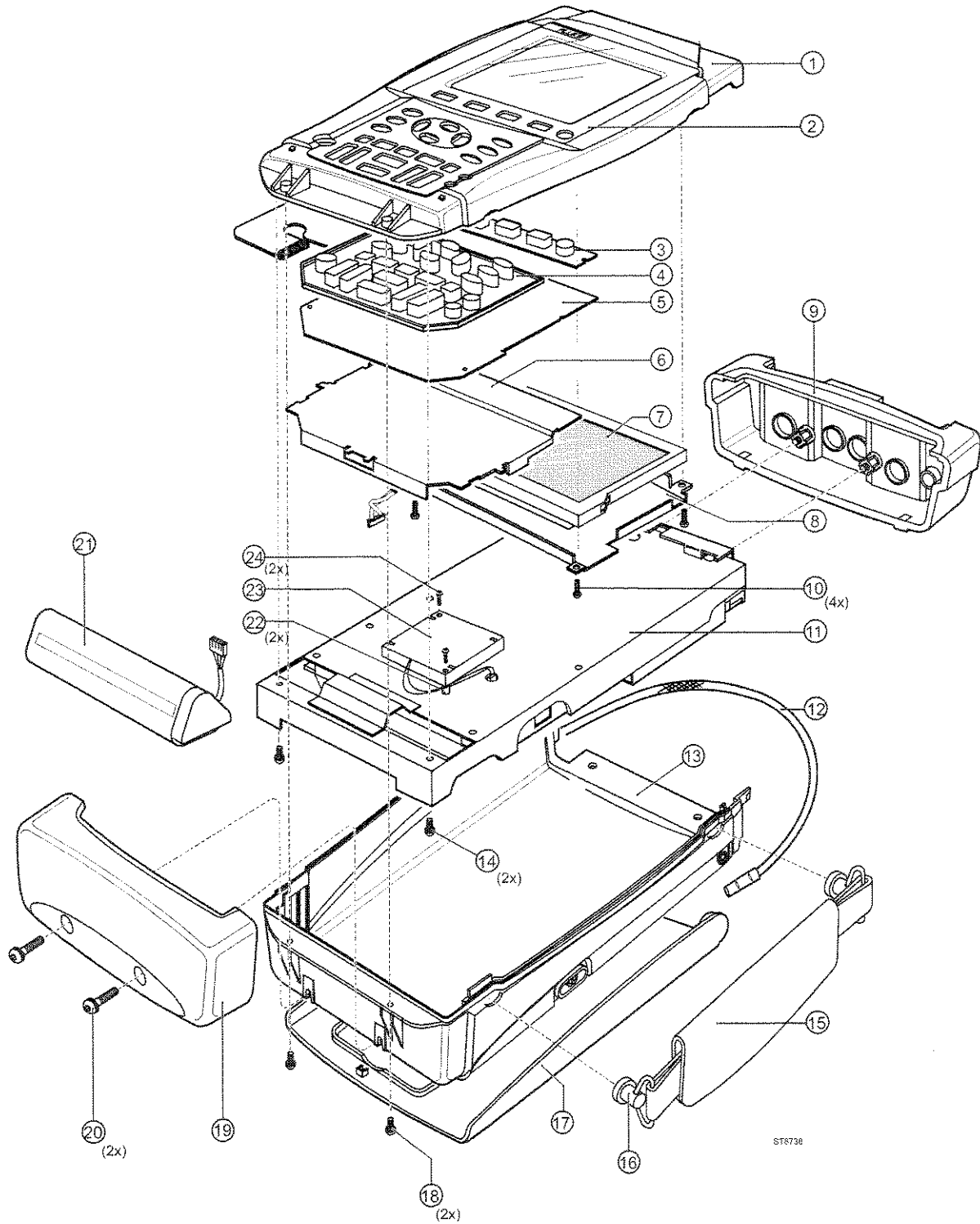
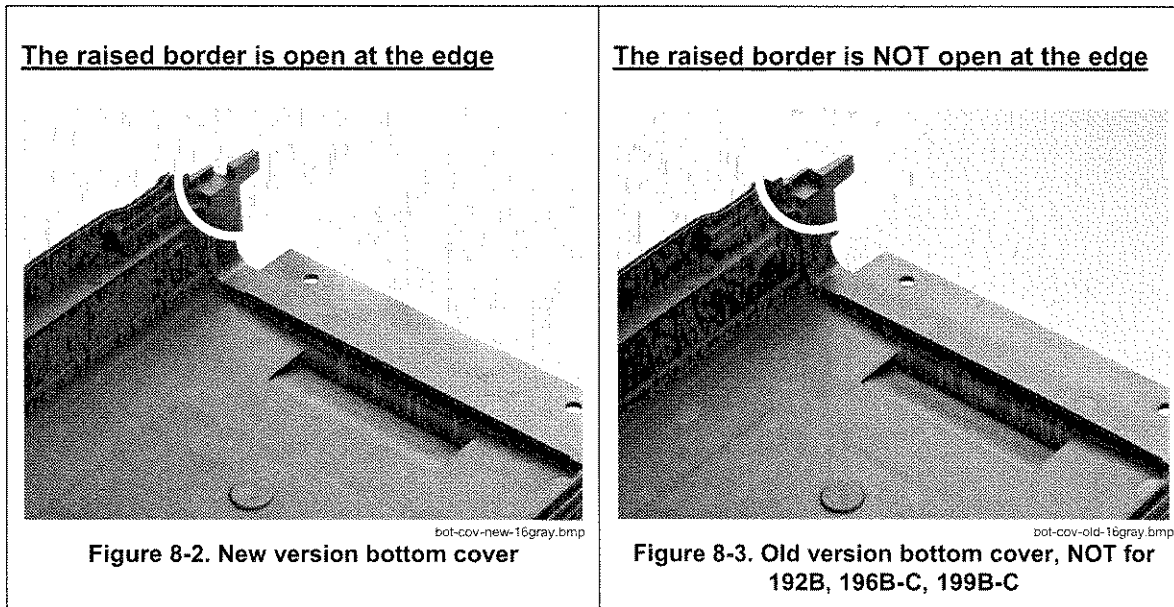

Figure 8-1. Final Assembly Details

st8738.wmf



8.5 Main PCA Unit Parts

See Table 8-2 and Figure 8-4 for the main PCA Unit parts.

Table 8-2. Main PCA Unit Parts

Item	Description	Ordering Code
1	Shielding box assy (includes rubber spacer, see fig. 8-5)	4022 244 98431
2	Insulation foil	4022 244 98241
3	PT-Screw K35x8	4022 244 92791
4	Input connector unit	4022 244 98251
5	sealing ring for power connector	4022 244 98331
6	Input attenuator shielding:	
	- METER channel top	4022 244 98261
	- METER channel bottom	4022 244 98271
	- SCOPE channel A top	4022 244 98281
	- SCOPE channel B top	4022 244 98291
	- SCOPE channel A&B bottom	4022 244 98301
7	Screw Torx M3x20	2522 201 08038
8	Shielding cover	4022 243 08931
9	Combi-screw Torx M3x10 (screw + split spring)	4022 325 42101
10	Hexagonal spacer M3x16.5	4022 244 93071

Note 1

If the main PCA must be replaced, you must order the complete main PCA Unit.

Note 2

The Scope channel A and B input attenuator top shieldings are provided with a plate spring. The spring end is provided with heat conducting tape; it contacts the C-ASIC's N1000 and N1200, and transports the heat from the C-ASIC to the shielding.

Do not bend the springs, keep the tape on the spring end free of dust, and put the shielding on the correct position.

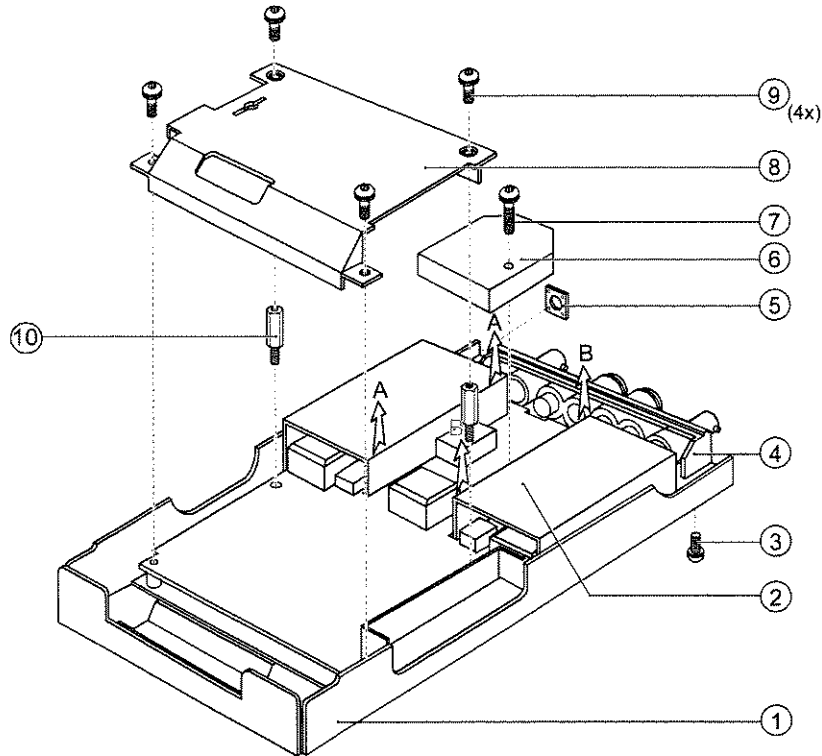

ST8676

ST8676.wmf

Figure 8-4. Main PCA Unit

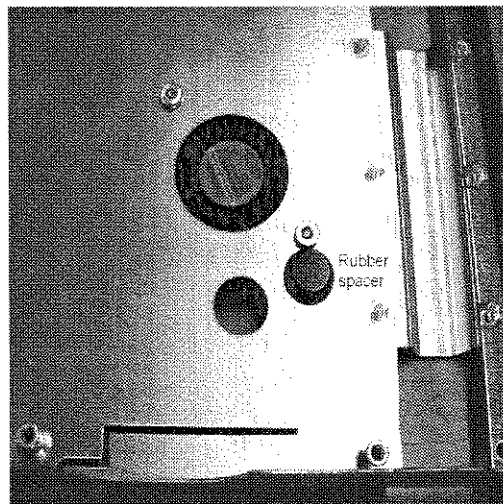

rubber-spacer-16gray.jpg

Figure 8-5. Rubber Spacer on Shielding Box Assy

8.6 Main PCA Parts

See Figure 9-11 and Figure 9-12 at the end of Chapter 9 for the main PCA reference designation views.

If a part has a an ordering code that depends on the Main PCA Unit version, this is indicated with (OLD) and (NEW) behind the parts description. See Section 10.4 for more information about the old and new version Main PCA unit.

Table 8-3. Main PCA Parts

Item	Description	Location on Main PCA		Ordering Code
		top	bottom	
A201	FLASH/SRAM MODULE 1M x 16 (OLD)	D1		4022 246 19431
	FLASH/SRAM MODULE 512k x 16 (NEW)	D1		4022 246 19841
B2000	QUARTZ CRYSTAL 25.00MHZ	C2		4022 303 20181
B3500	QUARTZ CRYSTAL 3.6864MHZ	B1		4022 303 20201
B3501	QUARTZ CRYSTAL 32.768KHZ		C1	4022 303 20291
B3502	QUARTZ CRYSTAL 40.00MHZ	B1		4022 303 20271
C1000	CERCAP X5R 1206 10% 1UF		A5	5322 126 14089
C1001	CER CAP 1 500V 2% 12PF	D5		2222 654 10129
C1002	CER CAP 1 500V 2% 12PF	D5		2222 654 10129
C1003	CER CAP 1 500V 2% 12PF	D5		2222 654 10129
C1004	CER CAP 1 500V 2% 12PF	D5		2222 654 10129
C1010	CER CAP 1 500V 0.25PF 2.2PF	D5		2222 654 09228
C1011	CER CAP 1 500V 0.25PF 2.2PF	D5		2222 654 09228
C1012	CER CAP 1 500V 0.25PF 2.2PF	C5		2222 654 09228
C1013	CER CAP 1 500V 0.25PF 2.2PF	C5		2222 654 09228
C1014	CER CAP 1 500V 0.25PF 2.2PF	C5		2222 654 09228
C1025	CC 4.7PF 6% 0805 NP0 50V		A5	4022 301 60131
C1029	CC 12PF 5% 0805 NP0 50V		B5	4022 301 60181
C1030	CC 12PF 5% 0805 NP0 50V		B5	4022 301 60181
C1031	CC .47PF 50% 0805 NP0 50V	D4		4022 301 60011
C1032	CC 10PF 5% 0805 NP0 50V	D4		4022 301 60171
C1033	CC 100PF 5% 0805 NP0 50V	D4		4022 301 60291
C1034	CC 1NF 5% 0805 NP0 50V	D4		4022 301 60411
C1038	CC 1NF 5% 0805 NP0 50V		A4	4022 301 60411
C1039	CC 22NF 10% 0805 X7R 50V		A4	4022 301 60491
C1040	CC 470PF 5% 0805 NP0 50V		A4	4022 301 60371
C1041	CC 470PF 5% 0805 NP0 50V	D4		4022 301 60371
C1044	CER CAP 1 500V 0.25PF 1.2PF	D5		2222 654 03128
C1045	CC 22NF 10% 0805 X7R 50V	D4		4022 301 60491
C1050	MKC CAP 250V 10% 68NF	D5		2222 344 48683
C1062	CC 100NF 10% 0805 X7R 50V		A4	4022 301 61331
C1063	CC 100NF 10% 0805 X7R 50V		B4	4022 301 61331
C1064	CC 100NF 10% 0805 X7R 50V		A4	4022 301 61331
C1065	CC 100NF 10% 0805 X7R 50V		A4	4022 301 61331
C1073	CC 4.7NF 10% 0805 X7R 50V	C4		4022 301 60451
C1082	CC 22NF 10% 0805 X7R 50V	C4		4022 301 60491

Item	Description	Location on Main PCA		Ordering Code
		top	bottom	
C1083	CC 100NF 10% 0805 X7R 50V		A4	4022 301 61331
C1092	CC 100NF 10% 0805 X7R 50V		A4	4022 301 61331
C1093	CC 100NF 10% 0805 X7R 50V		B5	4022 301 61331
C1094	CC 100NF 10% 0805 X7R 50V		A4	4022 301 61331
C1095	CC 100NF 10% 0805 X7R 50V		A4	4022 301 61331
C1096	CC 100NF 10% 0805 X7R 50V		A4	4022 301 61331
C1097	CC 100NF 10% 0805 X7R 50V		A4	4022 301 61331
C1098	CC 100NF 10% 0805 X7R 50V		A5	4022 301 61331
C1099	CC 100NF 10% 0805 X7R 50V		A5	4022 301 61331
C1100	CC 33PF 5% 0805 NP0 50V	C4		4022 301 60231
C1101	CC 33PF 5% 0805 NP0 50V	D4		4022 301 60231
C1102	CERCAP X5R 1206 10% 1UF		A4	5322 126 14089
C1104	CERCAP X5R 1206 10% 1UF		A4	5322 126 14089
C1108	ELCAP 25V SMD 20% 10UF	C3		5322 124 11838
C1109	CC 100NF 10% 0805 X7R 50V	C3		4022 301 61331
C1112	CC 10NF 10% 0805 X7R 50V	C4		4022 301 60471
C1125	CC 2.2NF 1% 1206 NP0 25V		B4	4022 301 61181
C1131	CC 2.2NF 1% 1206 NP0 25V		B3	4022 301 61181
C1133	CC 1NF 5% 0805 NP0 50V		B3	4022 301 60411
C1140	TACAP 6V SMD 20% 68UF (OLD) CAP 68UF 20% 6.3V NBO CASE-C (NEW)	D4 D4		4022 301 61341 4022 301 63731
C1141	TACAP 6.3V SMD 20% 100UF (OLD) CAP 22UF 6.3V 10% X5R 1210 (NEW)	D4 D4		4022 301 61211 4022 101 00021
C1142	TACAP 6V SMD 20% 68UF (OLD) CAP 68UF 20% 6.3V NBO CASE-C (NEW)	D4 D4		4022 301 61341 4022 301 63731
C1143	TACAP 6.3V SMD 20% 100UF (OLD) CAP 22UF 6.3V 10% X5R 1210 (NEW)	D4 D4		4022 301 61211 4022 101 00021
C1144	TACAP 6V SMD 20% 68UF (OLD) CAP 68UF 20% 6.3V NBO CASE-C (NEW)	D4 D4		4022 301 61341 4022 301 63731
C1145	TACAP 6.3V SMD 20% 100UF (OLD) CAP 68UF 20% 6.3V NBO CASE-C (NEW)	D4 D4		4022 301 61211 4022 101 00021
C1150	CC 100NF 10% 0805 X7R 50V		A4	4022 301 61331
C1200	CERCAP X5R 1206 10% 1UF		D5	5322 126 14089
C1201	CER CAP 1 500V 2% 12PF	A5		2222 654 10129
C1202	CER CAP 1 500V 2% 12PF	A5		2222 654 10129
C1203	CER CAP 1 500V 2% 12PF	A5		2222 654 10129
C1204	CER CAP 1 500V 2% 12PF	A5		2222 654 10129
C1210	CER CAP 1 500V 0.25PF 2.2PF	A5		2222 654 09228
C1211	CER CAP 1 500V 0.25PF 2.2PF	A5		2222 654 09228
C1212	CER CAP 1 500V 0.25PF 2.2PF	B5		2222 654 09228
C1213	CER CAP 1 500V 0.25PF 2.2PF	B5		2222 654 09228
C1214	CER CAP 1 500V 0.25PF 2.2PF	B5		2222 654 09228
C1225	CC 4.7PF 6% 0805 NP0 50V		D5	4022 301 60131
C1229	CC 12PF 5% 0805 NP0 50V		C5	4022 301 60181
C1230	CC 12PF 5% 0805 NP0 50V		C5	4022 301 60181
C1231	CC .47PF 50% 0805 NP0 50V	B4		4022 301 60011
C1232	CC 10PF 5% 0805 NP0 50V	B4		4022 301 60171
C1233	CC 100PF 5% 0805 NP0 50V	B4		4022 301 60291
C1234	CC 1NF 5% 0805 NP0 50V	B4		4022 301 60411

Item	Description	Location on Main PCA		Ordering Code
		top	bottom	
C1238	CC 1NF 5% 0805 NP0 50V		D4	4022 301 60411
C1239	CC 22NF 10% 0805 X7R 50V		D4	4022 301 60491
C1240	CC 470PF 5% 0805 NP0 50V		C4	4022 301 60371
C1241	CC 470PF 5% 0805 NP0 50V	B4		4022 301 60371
C1244	CER CAP 1 500V 0.25PF 1.2PF	A5		2222 654 03128
C1245	CC 22NF 10% 0805 X7R 50V	A4		4022 301 60491
C1250	MKC CAP 250V 10% 68NF	A5		2222 344 48683
C1262	CC 100NF 10% 0805 X7R 50V		D4	4022 301 61331
C1263	CC 100NF 10% 0805 X7R 50V		D4	4022 301 61331
C1264	CC 100NF 10% 0805 X7R 50V		D4	4022 301 61331
C1265	CC 100NF 10% 0805 X7R 50V		D4/C4	4022 301 61331
C1273	CC 4.7NF 10% 0805 X7R 50V	A4		4022 301 60451
C1282	CC 22NF 10% 0805 X7R 50V	A4		4022 301 60491
C1283	CC 100NF 10% 0805 X7R 50V		D4	4022 301 61331
C1292	CC 100NF 10% 0805 X7R 50V		D4	4022 301 61331
C1293	CC 100NF 10% 0805 X7R 50V		D5	4022 301 61331
C1294	CC 100NF 10% 0805 X7R 50V		D4/C4	4022 301 61331
C1295	CC 100NF 10% 0805 X7R 50V		D4	4022 301 61331
C1296	CC 100NF 10% 0805 X7R 50V		D4	4022 301 61331
C1297	CC 100NF 10% 0805 X7R 50V		D4	4022 301 61331
C1298	CC 100NF 10% 0805 X7R 50V		D5	4022 301 61331
C1299	CC 100NF 10% 0805 X7R 50V		C5	4022 301 61331
C1300	CC 33PF 5% 0805 NP0 50V	A4		4022 301 60231
C1301	CC 33PF 5% 0805 NP0 50V	B4		4022 301 60231
C1302	CERCAP X5R 1206 10% 1UF		D4	5322 126 14089
C1304	CERCAP X5R 1206 10% 1UF		D4/C4	5322 126 14089
C1308	ELCAP 25V SMD 20% 10UF	B3		5322 124 11838
C1309	CC 100NF 10% 0805 X7R 50V	C3		4022 301 61331
C1312	CC 10NF 10% 0805 X7R 50V	B4		4022 301 60471
C1325	CC 2.2NF 1% 1206 NP0 25V	A4		4022 301 61181
C1331	CC 2.2NF 1% 1206 NP0 25V		B3	4022 301 61181
C1333	CC 1NF 5% 0805 NP0 50V		B3	4022 301 60411
C1340	TACAP 6V SMD 20% 68UF (OLD) A4 CAP 68UF 20% 6.3V NBO CASE-C (NEW) A4			4022 301 61341 4022 301 63731
C1341	TACAP 6.3V SMD 20% 100UF (OLD) A4 CAP 22UF 6.3V 10% X5R 1210 (NEW) A4			4022 301 61211 4022 101 00021
C1342	TACAP 6V SMD 20% 68UF (OLD) A4 CAP 68UF 20% 6.3V NBO CASE-C (NEW) A4			4022 301 61341 4022 301 63731
C1343	TACAP 6.3V SMD 20% 100UF (OLD) A4 CAP 22UF 6.3V 10% X5R 1210 (NEW) A4			4022 301 61211 4022 101 00021
C1344	TACAP 6V SMD 20% 68UF (OLD) A4 CAP 22UF 6.3V 10% X5R 1210 (NEW) A4			4022 301 61341 4022 101 00021
C1345	TACAP 6.3V SMD 20% 100UF (OLD) A4 CAP 22UF 6.3V 10% X5R 1210 (NEW) A4			4022 301 61211 4022 101 00021
C1346	CC 10NF 10% 0805 X7R 50V		D3	4022 301 60471
C1350	CC 100NF 10% 0805 X7R 50V		D4	4022 301 61331
C1500	CC 10NF 10% 0805 X7R 50V		C4	4022 301 60471
C1501	CC 10NF 10% 0805 X7R 50V		C4	4022 301 60471
C1504	CC 22PF 5% 0805 NP0 50V	C4		4022 301 60211

Item	Description	Location on Main PCA		Ordering Code
		top	bottom	
C1505	CC 220PF 5% 0805 NP0 50V	C4		4022 301 60331
C1506	CC 2.2NF 10% 0805 X7R 50V	C5		4022 301 60431
C1507	CC 22NF 10% 0805 X7R 50V	C5		4022 301 60491
C1508	CC 22PF 5% 0805 NP0 50V	B4		4022 301 60211
C1523	CC 22PF 5% 0805 NP0 50V	C4		4022 301 60211
C1524	CC 150PF 5% 0805 NP0 50V	C4		4022 301 60311
C1526	CC 22PF 5% 0805 NP0 50V	C4		4022 301 60211
C1530	CC 1NF 5% 0805 NP0 50V		B3	4022 301 60411
C1538	CC 22NF 10% 0805 X7R 50V		B4	4022 301 60491
C1550	CC 10NF 10% 0805 X7R 50V	C5		4022 301 60471
C1551	CC 100NF 10% 0805 X7R 50V		B5	4022 301 61331
C1560	CC 100PF 5% 0805 NP0 50V			4022 301 60291
C1570	CC 1NF 5% 0805 NP0 50V		B4	4022 301 60411
C1575	CERCAP X5R 1206 10% 1UF		C4/B4	5322 126 14089
C1576	ELCAP 25V SMD 20% 10UF	C4		5322 124 11838
C1577	TACAP 10V SMD 20% 100UF (OLD) CAP 100UF 10% 10V SMD MNR (NEW)		C4	4022 301 61231 4022 301 61531
C1578	ELCAP 25V SMD 20% 10UF	B4		5322 124 11838
C1579	TACAP 10V SMD 20% 100UF (OLD) CAP 100UF 10% 10V SMD MNR (NEW)		C4	4022 301 61231 4022 301 61531
C1580	CC 100NF 10% 0805 X7R 50V		C4	4022 301 61331
C1586	CC 100NF 10% 0805 X7R 50V	C4		4022 301 61331
C1587	CC 100NF 10% 0805 X7R 50V		B4	4022 301 61331
C1588	CC 100NF 10% 0805 X7R 50V		C4	4022 301 61331
C1589	CC 100NF 10% 0805 X7R 50V		C4	4022 301 61331
C1590	CC 100NF 10% 0805 X7R 50V		C4	4022 301 61331
C1592	CC 100NF 10% 0805 X7R 50V		B4	4022 301 61331
C1593	CC 100NF 10% 0805 X7R 50V		C5	4022 301 61331
C1594	CC 100NF 10% 0805 X7R 50V		B4	4022 301 61331
C1595	CC 100NF 10% 0805 X7R 50V		B4	4022 301 61331
C1596	CC 100NF 10% 0805 X7R 50V		C4	4022 301 61331
C1597	CC 100NF 10% 0805 X7R 50V		B5	4022 301 61331
C2000	CC 2.2NF 10% 0805 X7R 50V		B3	4022 301 60431
C2001	CC 2.2NF 10% 0805 X7R 50V		B3	4022 301 60431
C2002	CC 2.2NF 10% 0805 X7R 50V		B3	4022 301 60431
C2003	CC 22NF 10% 0805 X7R 50V		C3	4022 301 60491
C2004	CC 22NF 10% 0805 X7R 50V		C3	4022 301 60491
C2005	CC 22NF 10% 0805 X7R 50V		C3	4022 301 60491
C2006	CC 22NF 10% 0805 X7R 50V		C3	4022 301 60491
C2007	CC 100NF 10% 0805 X7R 50V		B3	4022 301 61331
C2008	CERCAP X5R 1206 10% 1UF		B3	5322 126 14089
C2010	CC 220PF 5% 0805 NP0 50V		C2	4022 301 60331
C2011	CC 10NF 10% 0805 X7R 50V		B2	4022 301 60471
C2015	CC 470PF 5% 0805 NP0 50V		B2	4022 301 60371
C2020	CC 100NF 10% 0805 X7R 50V	B3		4022 301 61331
C2021	CC 100NF 10% 0805 X7R 50V	B2		4022 301 61331
C2022	CC 100NF 10% 0805 X7R 50V	B2		4022 301 61331
C2023	CC 1PF 25% 0805 NP0 50V		C2	4022 301 60051

Item	Description	Location on Main PCA		Ordering Code
		top	bottom	
C2024	CC 1PF 25% 0805 NP0 50V		C2	4022 301 60051
C2025	CC 1PF 25% 0805 NP0 50V		C2	4022 301 60051
C2026	CC 15PF 5% 0805 NP0 50V	B2		4022 301 60191
C2028	CC 2.2PF 11% 0805 NP0 50V		B1	4022 301 60091
C2030	CC 2.2PF 11% 0805 NP0 50V		B1	4022 301 60091
C2031	CC 2.2PF 11% 0805 NP0 50V		B1	4022 301 60091
C2032	CC 2.2PF 11% 0805 NP0 50V		B1	4022 301 60091
C2033	CC 1PF 25% 0805 NP0 50V		B2	4022 301 60051
C2034	CC 4.7PF 6% 0805 NP0 50V		B2	4022 301 60131
C2036	CC 39PF 5% 0805 NP0 50V	C2		4022 301 60241
C2037	CC 39PF 5% 0805 NP0 50V		B2	4022 301 60241
C2038	CC 39PF 5% 0805 NP0 50V		B2	4022 301 60241
C2039	CC 2.2NF 10% 0805 X7R 50V		B2	4022 301 60431
C2050	CC 100NF 10% 0805 X7R 50V		B2	4022 301 61331
C2051	CC 100NF 10% 0805 X7R 50V		B2	4022 301 61331
C2052	ELCAP 25V SMD 20% 10UF	C2		5322 124 11838
C2053	CC 100NF 10% 0805 X7R 50V		B2	4022 301 61331
C2054	CC 100NF 10% 0805 X7R 50V		B2	4022 301 61331
C2055	ELCAP 25V SMD 20% 10UF	B2		5322 124 11838
C2058	CC 100NF 10% 0805 X7R 50V	D2		4022 301 61331
C2059	CC 100NF 10% 0805 X7R 50V	D2		4022 301 61331
C2060	CC 4.7NF 10% 0805 X7R 50V	B2		4022 301 60451
C2061	CC 100NF 10% 0805 X7R 50V		B2	4022 301 61331
C2062	CC 100NF 10% 0805 X7R 50V	C2		4022 301 61331
C2063	CC 22NF 10% 0805 X7R 50V	B2		4022 301 60491
C2064	CC 100NF 10% 0805 X7R 50V	B2		4022 301 61331
C2065	CC 100NF 10% 0805 X7R 50V	B2		4022 301 61331
C2200	ELCAP 25V SMD 20% 10UF	B3		5322 124 11838
C2201	CC 100NF 10% 0805 X7R 50V		B3	4022 301 61331
C2202	CC 100NF 10% 0805 X7R 50V		B2	4022 301 61331
C2203	CC 100NF 10% 0805 X7R 50V		B2	4022 301 61331
C2204	CC 100NF 10% 0805 X7R 50V		B3	4022 301 61331
C2205	CC 100NF 10% 0805 X7R 50V		B2	4022 301 61331
C2206	TACAP 6.3V SMD 20% 100UF		B2	4022 301 61211
C2210	CC 100NF 10% 0805 X7R 50V		B3	4022 301 61331
C2211	CC 100NF 10% 0805 X7R 50V		B3	4022 301 61331
C2212	CC 100NF 10% 0805 X7R 50V		B3	4022 301 61331
C2213	CC 100NF 10% 0805 X7R 50V		B3	4022 301 61331
C2214	CC 100NF 10% 0805 X7R 50V		B2	4022 301 61331
C2216	TACAP 6.3V SMD 20% 100UF	B3		4022 301 61211
C2220	CC 100NF 10% 0805 X7R 50V	C2		4022 301 61331
C2221	CC 100NF 10% 0805 X7R 50V		B2	4022 301 61331
C2222	CC 100NF 10% 0805 X7R 50V		B2	4022 301 61331
C2230	ELCAP 25V SMD 20% 10UF	B3		5322 124 11838
C2231	CC 100NF 10% 0805 X7R 50V	B3		4022 301 61331
C2232	CC 100NF 10% 0805 X7R 50V		B2	4022 301 61331
C2233	CC 100NF 10% 0805 X7R 50V		B2	4022 301 61331
C2240	ELCAP 25V SMD 20% 10UF	B2		5322 124 11838

Item	Description	Location on Main PCA		Ordering Code
		top	bottom	
C2241	CC 100NF 10% 0805 X7R 50V		B2	4022 301 61331
C2242	ELCAP 25V SMD 20% 10UF	B2		5322 124 11838
C2243	CC 100NF 10% 0805 X7R 50V		B2	4022 301 61331
C2250	ELCAP 25V SMD 20% 10UF	B3		5322 124 11838
C2251	CC 100NF 10% 0805 X7R 50V	B3		4022 301 61331
C2252	CC 100NF 10% 0805 X7R 50V		B2	4022 301 61331
C2253	CC 100NF 10% 0805 X7R 50V		B2	4022 301 61331
C2254	CC 100NF 10% 0805 X7R 50V		B3	4022 301 61331
C2255	CC 100NF 10% 0805 X7R 50V		B3	4022 301 61331
C2260	CC 100NF 10% 0805 X7R 50V		B3	4022 301 61331
C2261	CC 100NF 10% 0805 X7R 50V		B2	4022 301 61331
C2262	CC 100NF 10% 0805 X7R 50V		B2	4022 301 61331
C2263	CC 100NF 10% 0805 X7R 50V		B2	4022 301 61331
C2264	CC 100NF 10% 0805 X7R 50V		B2	4022 301 61331
C2270	ELCAP 25V SMD 20% 10UF	B3		5322 124 11838
C2271	CC 100NF 10% 0805 X7R 50V		B3	4022 301 61331
C2272	CC 100NF 10% 0805 X7R 50V		B3	4022 301 61331
C2273	CC 100NF 10% 0805 X7R 50V		B3	4022 301 61331
C2274	CC 100NF 10% 0805 X7R 50V		B2	4022 301 61331
C2280	CC 100NF 10% 0805 X7R 50V		B3	4022 301 61331
C2281	CC 100NF 10% 0805 X7R 50V		B3	4022 301 61331
C2282	CC 100NF 10% 0805 X7R 50V		B2	4022 301 61331
C2283	CC 100NF 10% 0805 X7R 50V		B2	4022 301 61331
C2284	CC 100NF 10% 0805 X7R 50V		B2	4022 301 61331
C2291	CC 100NF 10% 0805 X7R 50V		B2	4022 301 61331
C2292	CC 100NF 10% 0603 X7R 16V	C2		4022 301 61681
C3000	CC 4.7PF 6% 0805 NP0 50V		B2	4022 301 60131
C3001	CC 100NF 10% 0805 X7R 50V (OLD) ELCAP 25V SMD 20% 10UF (NEW)	B2	B2	4022 301 61331 5322 124 11838
C3002	ELCAP 25V SMD 20% 10UF (NEW)	B2		5322 124 11838
C3003	CC 100NF 10% 0805 X7R 50V		B2	4022 301 61331
C3004	CC 100NF 10% 0805 X7R 50V		B2	4022 301 61331
C3010	CC 100NF 10% 0805 X7R 50V		B2	4022 301 61331
C3011	ELCAP 25V SMD 20% 10UF (OLD) CC 100NF 10% 0805 X7R 50V (NEW)	B3	B2	5322 124 11838 4022 301 61331
C3012	CC 100NF 10% 0805 X7R 50V		B2	4022 301 61331
C3013	CC 100NF 10% 0805 X7R 50V		B2	4022 301 61331
C3014	CC 100NF 10% 0805 X7R 50V		B2	4022 301 61331
C3015	ELCAP 25V SMD 20% 10UF		B2	5322 124 11838
C3016	CC 100NF 10% 0805 X7R 50V		B2	4022 301 61331
C3019	CC 4.7NF 6% 0805 NP0 50V		B2	4022 301 60131
C3051	CC 100NF 10% 0805 X7R 50V		B2	4022 301 61331
C3100	CC 4.7PF 6% 0805 NP0 50V		B2	4022 301 60131
C3101	CC 100NF 10% 0805 X7R 50V		C2	4022 301 61331
C3103	CC 100NF 10% 0805 X7R 50V		B2	4022 301 61331
C3104	CC 100NF 10% 0805 X7R 50V		B2	4022 301 61331
C3110	CC 100NF 10% 0805 X7R 50V		B2 OLD C2 NEW	4022 301 61331

Item	Description	Location on Main PCA		Ordering Code
		top	bottom	
C3111	CC 100NF 10% 0805 X7R 50V		C2	4022 301 61331
C3112	CC 100NF 10% 0805 X7R 50V		B2	4022 301 61331
C3113	CC 100NF 10% 0805 X7R 50V		B2	4022 301 61331
C3114	CC 100NF 10% 0805 X7R 50V		B2	4022 301 61331
C3115	ELCAP 25V SMD 20% 10UF		C2	5322 124 11838
C3116	CC 100NF 10% 0805 X7R 50V		B2	4022 301 61331
C3119	CC 4.7PF 6% 0805 NP0 50V		C2	4022 301 60131
C3200	CC 100NF 10% 0805 X7R 50V		C2	4022 301 61331
C3201	CC 100NF 10% 0805 X7R 50V		C2	4022 301 61331
C3300	CC 4.7NF 10% 0805 X7R 50V		B1	4022 301 60451
C3301	CC 4.7NF 10% 0805 X7R 50V		B1	4022 301 60451
C3302	CC 4.7NF 10% 0805 X7R 50V		B1	4022 301 60451
C3310	CC 4.7NF 10% 0805 X7R 50V		B1	4022 301 60451
C3311	CC 100NF 10% 0805 X7R 50V		B1	4022 301 61331
C3312	CC 100NF 10% 0805 X7R 50V		B1	4022 301 61331
C3313	CC 100NF 10% 0805 X7R 50V		B1	4022 301 61331
C3401	CC 100NF 10% 0805 X7R 50V	A2		4022 301 61331
C3402	CC 100NF 10% 0805 X7R 50V	A2		4022 301 61331
C3403	CC 47PF 5% 0805 NP0 50V		D2	4022 301 60251
C3500	CC 100NF 10% 0805 X7R 50V		B1	4022 301 61331
C3501	CC 100NF 10% 0805 X7R 50V	C1		4022 301 61331
C3502	CC 100NF 10% 0805 X7R 50V		C1	4022 301 61331
C3504	CC 100NF 10% 0805 X7R 50V		B1	4022 301 61331
C3505	CC 100NF 10% 0805 X7R 50V		B1	4022 301 61331
C3506	CC 100NF 10% 0805 X7R 50V		B1	4022 301 61331
C3507	CC 100NF 10% 0805 X7R 50V		B1	4022 301 61331
C3510	CC 22NF 10% 0805 X7R 50V		C1	4022 301 60491
C3511	CC 100NF 10% 0805 X7R 50V		B1/C1	4022 301 61331
C3512	CC 100NF 10% 0805 X7R 50V	C1		4022 301 61331
C3513	CC 100PF 5% 0805 NP0 50V		C1	4022 301 60291
C3514	CC 100PF 5% 0805 NP0 50V		C1	4022 301 60291
C3515	CC 100NF 10% 0805 X7R 50V		C1	4022 301 61331
C3519	CC 22NF 10% 0805 X7R 50V	D1		4022 301 60491
C3533	CC 100NF 10% 0805 X7R 50V		B1	4022 301 61331
C3534	CC 100NF 10% 0805 X7R 50V		B1	4022 301 61331
C3540	CC 47PF 5% 0805 NP0 50V		C1	4022 301 60251
C3541	CC 47PF 5% 0805 NP0 50V		C1	4022 301 60251
C3543	CC 18PF 5% 0805 NP0 50V		C1	4022 301 60201
C3544	CC 18PF 5% 0805 NP0 50V		C1	4022 301 60201
C3546	CC 4.7PF 6% 0805 NP0 50V		C1	4022 301 60131
C3550	CC 100NF 10% 0805 X7R 50V		C2	4022 301 61331
C3600	CC 100NF 10% 0805 X7R 50V	D3		4022 301 61331
C3611	CC 100NF 10% 0805 X7R 50V		A3	4022 301 61331
C3612	CC 100NF 10% 0805 X7R 50V		A3	4022 301 61331
C3613	CC 100NF 10% 0805 X7R 50V		A3	4022 301 61331
C3614	CC 100NF 10% 0805 X7R 50V		A2	4022 301 61331
C3615	CC 100NF 10% 0805 X7R 50V		A1	4022 301 61331
C3616	CC 100NF 10% 0805 X7R 50V		A1	4022 301 61331

Item	Description	Location on Main PCA		Ordering Code
		top	bottom	
C3617	CC 100NF 10% 0805 X7R 50V		A1	4022 301 61331
C3618	CC 100NF 10% 0805 X7R 50V		A1	4022 301 61331
C3619	ELCAP 35V SMD 4.7UF	D2		2020 021 91157
C3621	CC 100NF 10% 0805 X7R 50V	D1		4022 301 61331
C3622	CC 100NF 10% 0805 X7R 50V	D1		4022 301 61331
C3623	CC 22NF 10% 0805 X7R 50V		A3	4022 301 60491
C3700	CC 100NF 10% 0805 X7R 50V		A1	4022 301 61331
C4000	ELCAP 25V RAD 20% 470UF	B2		4022 301 61271
C4001	ELCAP 25V RAD 20% 470UF	B2		4022 301 61271
C4002	CC 100NF 10% 0805 X7R 50V		D2	4022 301 61331
C4004	CC 10NF 10% 0805 X7R 50V		D2	4022 301 60471
C4005	CC 1NF 5% 0805 NP0 50V		D2	4022 301 60411
C4008	TACAP 6.3V SMD 20% 100UF (OLD) CAP 100UF 20% 6.3V NBO CASE-D (NEW)		C2 C2	4022 301 61211 4022 101 00201
C4009	CC 100NF 10% 0805 X7R 50V		C1	4022 301 61331
C4010	TACAP 6.3V SMD 20% 100UF	A2		4022 301 61211
C4011	TACAP 6.3V SMD 20% 220UF (OLD) CAP 220UF 6.3V 10% X5R 1210 (NEW)	A2 A2		4022 301 62071 4022 301 63741
C4012	TACAP 6.3V SMD 20% 100UF (OLD) CAP 22UF 6.3V 10% X5R 1210 (NEW)	A2 A2		4022 301 61211 4022 101 00021
C4014	TACAP 6V SMD 20% 68UF (OLD) CAP 68UF 20% 6.3V NBO CASE-C (NEW)		D2 D2	4022 301 61341 4022 301 63731
C4015	TACAP 6.3V SMD 20% 100UF (OLD) CAP 22UF 6.3V 10% X5R 1210 (NEW)		D2 D2	4022 301 61211 4022 101 00021
C4016	ELCAP 25V SMD 20% 10UF	B3		5322 124 11838
C4020	TACAP 6.3V SMD 20% 100UF (OLD) CAP 22UF 6.3V 10% X5R 1210 (NEW)	A3 A3		4022 301 61211 4022 101 00021
C4021	TACAP 6V SMD 20% 68UF (OLD) CAP 68UF 20% 6.3V NBO CASE-C (NEW)		D3 D3	4022 301 61341 4022 301 63731
C4022	TACAP 6.3V SMD 20% 100UF (OLD) CAP 22UF 6.3V 10% X5R 1210 (NEW)	A3 A3		4022 301 61211 4022 101 00021
C4023	TACAP 6V SMD 20% 68UF (OLD) CAP 68UF 20% 6.3V NBO CASE-C (NEW)		D3 D3	4022 301 61341 4022 301 63731
C4024	ELCAP 35V SMD 20% 47UF	A3		5322 124 11842
C4025	ELCAP 25V SMD 20% 10UF	A3		5322 124 11838
C4030	CERCAP X5R 1206 10% 1UF		D2	5322 126 14089
C4031	CC 22NF 10% 0805 X7R 50V	A1		4022 301 60491
C4032	CC 22NF 10% 0805 X7R 50V		D1	4022 301 60491
C4033	CC 22NF 10% 0805 X7R 50V		D2	4022 301 60491
C4034	ELCAP 25V SMD 20% 10UF	A1		5322 124 11838
C4040	CC 100NF 10% 0805 X7R 50V		D2	4022 301 61331
C4100	CC 100NF 10% 0805 X7R 50V		C1	4022 301 61331
C4101	CC 100NF 10% 0805 X7R 50V		C1	4022 301 61331
C4102	CERCAP X5R 1206 10% 1UF		D1	5322 126 14089
C4103	CERCAP X5R 1206 10% 1UF		C1	5322 126 14089
C4104	CC 100NF 10% 0805 X7R 50V		D1	4022 301 61331
C4110	CERCAP Y5V 1206 10% 1UF		D5	2022 552 94107
C4111	ELCAP 25V RAD 20% 470UF	A1		4022 301 61271
C4112	ELCAP 25V SMD 20% 10UF	B2		5322 124 11838

Item	Description	Location on Main PCA		Ordering Code
		top	bottom	
C4113	CC 100NF 10% 0805 X7R 50V		C1	4022 301 61331
C4114	ELCAP 25V RAD 20% 470UF	B1		4022 301 61271
C4115	CC 10NF 10% 0805 X7R 50V		D1	4022 301 60471
C4120	ELCAP 25V SMD 20% 10UF	A2		5322 124 11838
C4121	CC 100NF 10% 0805 X7R 50V		D1	4022 301 61331
C4122	CC 100NF 10% 0805 X7R 50V		D1	4022 301 61331
C4123	CC 150PF 5% 0805 NP0 50V	A2		4022 301 60311
C4200	CC 100NF 10% 0805 X7R 50V		A2	4022 301 61331
C4201	CERCAP X5R 1206 10% 1UF		A2	5322 126 14089
C4202	CC 680PF 5% 0805 NP0 50V		A2	4022 301 60391
C4203	CC 100NF 10% 0805 X7R 50V		A3	4022 301 61331
C4204	CC 10NF 10% 0805 X7R 50V		A3	4022 301 60471
C4210	CC 47NF 20% 0805 X7R 25V	D3		4022 301 60551
C4211	MKT FILM CAP 63V 10% 100NF	D3		2222 370 78104
C4212	CER.CAP. 2KV +-5% 33PF	D2		5322 126 14047
C4213	CERCAP X5R 1206 10% 1UF	D2		5322 126 14089
C4214	TACAP 100UF 16V AVX		A3	4022 301 62301
C4220	CC 100NF 10% 0805 X7R 50V		A3	4022 301 61331
C4221	CC 1NF 5% 0805 NP0 50V		A2	4022 301 60411
C4222	CC 100NF 10% 0805 X7R 50V		A3	4022 301 61331
C4223	CC 100NF 10% 0805 X7R 50V	D2		4022 301 61331
C4300	CC 100NF 10% 0805 X7R 50V		D1	4022 301 61331
C4301	CC 100NF 10% 0805 X7R 50V		D1	4022 301 61331
C4302	CC 100NF 10% 0805 X7R 50V		D1	4022 301 61331
C4303	CC 100NF 10% 0805 X7R 50V	A1		4022 301 61331
C4304	CC 100NF 10% 0805 X7R 50V	B1		4022 301 61331
C4310	CC 22NF 10% 0805 X7R 50V	B1		4022 301 60491
D1500	2X4-IN MUX/DM 74HC4052D	C4		9337 148 30653
D1501	8-INP MUX 74HC4051D	C4		9337 148 20653
D1502	8-INP MUX 74HC4051D	C4		9337 148 20653
D1560	2X4-IN MUX/DM 74HC4052D		B5	9337 148 30653
D1570	8-ST SH/ST REG 74HC4094D		C4	9337 148 50653
D1571	8-ST SH/ST REG 74HC4094D		B4	9337 148 50653
D1572	4 X 2-INP SCHM 74HC132D		B4	9337 141 30653
D2000	3X2 INP A/MUX 74HC4053D		C2	9337 148 40653
D2001	8X TRANSC.3ST 74LVC543APW	D2		4022 304 10311
D2002	8X TRANSC.3ST 74LVC543APW	D1		4022 304 10311
D2003	4 X 2-INP OR 74LVC32APW	C2		4022 304 10771
D2004	4 X 2-INP AND 74LVC08APW	C2		4022 304 11541
D2005	NC7WZ17	B2		4022 304 11691
D3000	LOW VOLT ADC TDA8792M/C2/R1 (OLD)	C2		5322 209 14837
	8B AD-CONV AD9280ARSRL SSOP28 (NEW)	C2		4022 103 00121
D3100	LOW VOLT ADC TDA8792M/C2/R1 (OLD)	C2		5322 209 14837
	8B AD-CONV AD9280ARSRL SSOP28 (NEW)	C2		4022 103 00121
D3202	2 X D-FF 74LVC74APW	B2		4022 304 10961
D3203	4 X 2-INP NAND 74LVC00APW	B2		4022 304 10971
D3500	D-ASIC SPIDER	C1		4022 304 11551

Item	Description	Location on Main PCA		Ordering Code
		top	bottom	
D3502	512KX8SRAM 32-TSOP-F (OLD) 4 MB SRAM 256x16 TSOP2 70 ns (NEW)		B1 B1	4022 304 10411 4022 30413241
D3503	512KX8SRAM 32-TSOP-F		A1	4022 304 10411
D3507	6320PUK25CY-T	B1		4022 304 11701
D3550	XCR3032XL	B1		4022 244 98441
D3551	NC7WZ17	B1		4022 304 11691
D3601	74HCT541PW	D1		4022 304 11561
D3602	74HCT541PW	D1		4022 304 11561
D3700	74LVC157AD-T QUAD 2INPUT MUX		A1	4022 304 13111
D4300	8-INP MUX 74HC4051D	A1		9337 148 20653
H1120	H.L.AN.OPTOCPLR HCNR201		B3	4022 304 10111
H1150	2X HS OPTOCPLR HCPL4534		A3	4022 304 10121
H1320	H.L.AN.OPTOCPLR HCNR201		C3	4022 304 10111
H1350	2X HS OPTOCPLR HCPL4534		D3	4022 304 10121
H1525	H.L.AN.OPTOCPLR HCNR201		B3	4022 304 10111
H1580	2X HS OPTOCPLR HCPL4534		C3	4022 304 10121
H3400	IR LED SFH409-2 (OLD) IR LED OP266A (NEW)	A2 A2		5322 130 61296 4022 103 01021
H3401	PHOTODIODE OP906 OPT	A2		5322 130 10777
H3500	PE SOUNDER PKM13EPP-4002	B3		5322 280 10311
K1000	RELAY DPDT TQ2SA-L-1.5V-Z	D4		4022 303 20051
K1200	RELAY DPDT TQ2SA-L-1.5V-Z	A4		4022 303 20051
K1500	DPDT RELAY DE1A1B-L5V	B4		4022 303 20011
L1001	CHIP INDUCT. 47UH 10%	D4		4822 157 70794
L1002	CHIP INDUCT. 47UH 10%	D4		4822 157 70794
L1003	CHIP INDUCT. 22UH 10%	D4		4022 301 92061
L1100	CHIP INDUCT. 0.027UH 5%	C3		2422 535 96815
L1101	CHIP INDUCT. 0.027UH 5%	C3		2422 535 96815
L1201	CHIP INDUCT. 47UH 10%	A4		4822 157 70794
L1202	CHIP INDUCT. 47UH 10%	A4		4822 157 70794
L1203	CHIP INDUCT. 22UH 10%	A4		4022 301 92061
L1300	CHIP INDUCT. 0.027UH 5%	C3		2422 535 96815
L1301	CHIP INDUCT. 0.027UH 5%	C3		2422 535 96815
L2200	CHIP INDUCT. 1UH 5%		C3	5322 157 63648
L2203	CHIP INDUCT. 22UH 10%		B3	4022 301 92061
L2212	CHIP INDUCT. 22UH 10%		C2	4022 301 92061
L2230	CHIP INDUCT. 1UH 5%		C3	5322 157 63648
L2250	CHIP INDUCT. 1UH 5%		C3	5322 157 63648
L3000	CHIP INDUCT. 47UH 10%	B3 OLD	C2 NEW	4822 157 70794
L4000	CHOKE 100UH	B1		4022 301 92071
L4001	CHIP INDUCT. 47UH 10%	A2		4822 157 70794
L4002	CHOKE 100UH	A3		4022 301 92071
L4003	CHOKE 100UH	A3		4022 301 92071
L4004	CHOKE 100UH	A3		4022 301 92071
L4010	CHIP INDUCT. 47UH 10%		D2	4822 157 70794

Item	Description	Location on Main PCA		Ordering Code
		top	bottom	
L4015	CHIP INDUCT. 47UH 10%		C3	4822 157 70794
L4100	SHIELDED CHOKE 22UH	B1		4022 301 92041
L4101	SHIELDED CHOKE 22UH	A1		4022 301 92041
L4200	CHIP INDUCT. 150UH	D3		4022 301 92341
L4201	CHIP INDUCT. 100UH	D3		4022 301 92351
N1000	C-ASIC OQ0260	D4		4022 244 89993
N1200	C-ASIC OQ0260	A4		4022 244 89993
N1500	HIGH PREC.OPAMP OP97EP	B4		4022 304 10611
N1501	2X CMOS OPAMP LM662AIM	B4		4022 304 10551
N1515	2X JFET OPAMP TLE2082CD	B4		5322 209 12943
N1525	2X CMOS OPAMP LM662AIM	C4		4022 304 10551
N1540	2X CMOS OPAMP LM662AIM	C5		4022 304 10551
N1541	LOW POW OPAMP LMC7101BIM5X	C5		5322 209 15144
N1575	L.D.O. VOLT.REG LP2981M5X-50		C4	4022 304 11051
N1576	NEG.LDO.VOLT.REG ILC7362CM-50		C4	4022 304 10591
N2000	LOW POW OPAMP LMC7101BIM5X	B2		5322 209 15144
N2001	S-ASIC IBM0001 JILL	C2		4022 244 89982
N2020	VID.SYNC.SEP. LM1881M		C2	9322 005 78685
N3401	LM393D IC (A) SO-8		D2	9336 559 70623
N3600	MC33171D		A1	4022 304 11571
N3601	MC33174D		A2	4022 304 11581
N4000	P-ASIC OQ0256	A1		4022 244 89203
N4200	LAMP CNTRLLR UC3872DW		A2	5322 209 14851
N4300	LOW POW OPAMP LMC7101BIM5X	B1		5322 209 15144
R1000	SMDRES 10K 1% MIX 0805		A5	4022 301 23091
R1001	SMDRES 10M 5% TC200 0805		A5	4022 301 22451
R1002	SMDRES 10M 5% TC200 0805		A5	4022 301 22451
R1003	SMDRES 10M 5% TC200 0805		A5	4022 301 22451
R1004	SMDRES 10M 5% TC200 0805		B5	4022 301 22451
R1010	SMDRES 464K 1% TC50 0805	C5		4022 301 22651
R1011	SMDRES 0E 0805	D5		4022 301 21281
R1012	SMDRES 100E 1% TC100 0805	D5		4022 301 21591
R1013	SMDRES 147E 1% TC100 0805	D5		4022 301 21631
R1014	SMDRES 100E 1% TC100 0805	D5		4022 301 21591
R1020	SMDRES 100E 1% TC100 0805	D5		4022 301 21591
R1021	SMDRES 46E4 1% TC100 0805	D5		4022 301 21511
R1022	SMDRES 46E4 1% TC100 0805	D5		4022 301 21511
R1023	SMDRES 178E 1% TC100 0805	C5		4022 301 21651
R1024	SMDRES 46E4 1% TC100 0805	C5		4022 301 21511
R1030	SMDRES 100E 1% TC100 0805	C5		4022 301 21591
R1031	SMDRES 619K 1% TC50 0805		A4	4022 301 22791
R1032	SMDRES 61K9 1% TC50 0805		A4	4022 301 22851
R1033	SMDRES 6K19 1% TC50 0805		A4	4022 301 22861
R1034	SMDRES 619E 1% TC50 0805		A4	4022 301 22871
R1038	SMDRES 261K 1% TC50 0805	D4		4022 301 22591
R1040	SMDRES 2K15 1% TC100 0805	D4		4022 301 21911

Item	Description	Location on Main PCA		Ordering Code
		top	bottom	
R1041	SMDRES 619K 1% TC50 0805	D4		4022 301 22791
R1046	SMDRES 909K 1% TC50 0805	D4		4022 301 22431
R1049	SMDRES 121K 1% TC100 0805	D4		4022 301 22321
R1050	MTL FILM RST MRS25 1% 487K	D5		2322 156 24874
R1051	MTL FILM RST MRS25 1% 487K	D5		2322 156 24874
R1052	SMDRES 26K1 1% TC50 0805		A5	4022 301 22581
R1053	RES RC12H 0805 1% 1M		A5	4822 117 11948
R1054	SMDRES 3K16 1% TC100 0805		A5	4022 301 21951
R1055	RES RC12H 0805 1% 1M		A5	4822 117 11948
R1056	RES RC12H 0805 1% 1M		A5	4822 117 11948
R1065	SMDRES 1M 1% TC50 0805	D4		4022 301 22441
R1066	RES RC12H 0805 1% 1M	D4		4822 117 11948
R1067	SMDRES 10M 5% TC200 0805	D4		4022 301 22451
R1068	SMDRES 121K 1% TC100 0805	D4		4022 301 22321
R1073	SMDRES 31K6 1% TC100 0805		A4	4022 301 22191
R1082	SMDRES 2K15 1% TC100 0805		A4	4022 301 21911
R1083	SMDRES 12K1 1% TC100 0805	D4		4022 301 22091
R1092	SMDRES 1E 1% TC250 0805		A4	4022 301 21291
R1093	SMDRES 4E64 1% TC250 0805		B4	4022 301 21331
R1094	SMDRES 10E 1% TC100 0805		A4	4022 301 21351
R1095	SMDRES 10E 1% TC100 0805		A4	4022 301 21351
R1096	SMDRES 10E 1% TC100 0805		A4	4022 301 21351
R1097	SMDRES 4E64 1% TC250 0805		B4	4022 301 21331
R1098	SMDRES 4E64 1% TC250 0805		A4	4022 301 21331
R1099	SMDRES 10E 1% TC100 0805		A4	4022 301 21351
R1100	SMDRES 1K 1% TC50 0805	C4		4022 301 21831
R1101	SMDRES 1K 1% TC50 0805	D4		4022 301 21831
R1102	SMDRES 46E4 1% TC100 0805		B4	4022 301 21511
R1103	SMDRES 46E4 1% TC100 0805		A4	4022 301 21511
R1104	SMDRES 464K 1% TC50 0805	C4		4022 301 22651
R1105	SMDRES 31E6 1% TC100 0805	C4		4022 301 21471
R1106	SMDRES 31E6 1% TC100 0805	D4		4022 301 21471
R1107	SMDRES 464K 1% TC50 0805	D4		4022 301 22651
R1108	SMDRES 3K83 1% TC100 0805	C3		4022 301 21971
R1109	SMDRES 1K 1% TC50 0805	C3		4022 301 21831
R1110	SMDRES 56E2 1% TC100 0805	C3		4022 301 21531
R1111	SMDRES 56E2 1% TC100 0805	C3		4022 301 21531
R1112	SMDRES 464E 1% TC100 0805	D4		4022 301 21751
R1113	SMDRES 464E 1% TC100 0805	D4		4022 301 21751
R1114	SMDRES 178E 1% TC100 0805	D4		4022 301 21651
R1115	SMDRES 178E 1% TC100 0805	D4		4022 301 21651
R1116	SMDRES 464K 1% TC50 0805	C4		4022 301 22651
R1117	SMDRES 4E64 1% TC250 0805	C3		4022 301 21331
R1118	SMDRES 4E64 1% TC250 0805	D3		4022 301 21331
R1122	SMDRES 3K16 .1% TC25 1206	C4		4022 301 22781
R1123	SMDRES 3K16 1% TC100 0805	C4		4022 301 21951
R1124	SMDRES 3K16 1% TC100 0805	C4		4022 301 21951
R1128	SMDRES 1K 1% TC50 0805		B4	4022 301 21831

Item	Description	Location on Main PCA		Ordering Code
		top	bottom	
R1129	SMDRES 1K 1% TC50 0805		A4	4022 301 21831
R1130	SMDRES 68E1 1% TC100 0805		B4	4022 301 21551
R1131	SMDRES 2K87 1% TC100 0805		B3	4022 301 21941
R1132	SMDRES 3K16 .1% TC25 1206		B3	4022 301 22781
R1133	SMDRES 3K16 1% TC100 0805		B3	4022 301 21951
R1134	SMDRES 1K 1% TC50 0805		B3	4022 301 21831
R1135	SMDRES 1K 1% TC50 0805		B3	4022 301 21831
R1136	SMDRES 3K16 1% TC100 0805		B3	4022 301 21951
R1139	SMDRES 7K5 1% TC100 0805		A4	4022 301 22041
R1150	SMDRES 1K 1% TC50 0805	D4		4022 301 21831
R1151	SMDRES 1K 1% TC50 0805	D4		4022 301 21831
R1152	SMDRES 46E4 1% TC100 0805		A3	4022 301 21511
R1153	SMDRES 46E4 1% TC100 0805		A3	4022 301 21511
R1200	SMDRES 10K 1% MIX 0805		D5	4022 301 23091
R1201	SMDRES 10M 5% TC200 0805		D5	4022 301 22451
R1202	SMDRES 10M 5% TC200 0805		D5	4022 301 22451
R1203	SMDRES 10M 5% TC200 0805		D5	4022 301 22451
R1204	SMDRES 10M 5% TC200 0805		C5	4022 301 22451
R1210	SMDRES 464K 1% TC50 0805	B5		4022 301 22651
R1211	SMDRES 0E 0805	A5		4022 301 21281
R1212	SMDRES 100E 1% TC100 0805	A5		4022 301 21591
R1213	SMDRES 147E 1% TC100 0805	A5		4022 301 21631
R1214	SMDRES 100E 1% TC100 0805	A5		4022 301 21591
R1220	SMDRES 100E 1% TC100 0805	A5		4022 301 21591
R1221	SMDRES 46E4 1% TC100 0805	A5		4022 301 21511
R1222	SMDRES 46E4 1% TC100 0805	A5		4022 301 21511
R1223	SMDRES 178E 1% TC100 0805	B5		4022 301 21651
R1224	SMDRES 46E4 1% TC100 0805	B5		4022 301 21511
R1230	SMDRES 100E 1% TC100 0805	B5		4022 301 21591
R1231	SMDRES 619K 1% TC50 0805		C4	4022 301 22791
R1232	SMDRES 61K9 1% TC50 0805		C4	4022 301 22851
R1233	SMDRES 6K19 1% TC50 0805		C4	4022 301 22861
R1234	SMDRES 619E 1% TC50 0805		C4	4022 301 22871
R1238	SMDRES 261K 1% TC50 0805	A4		4022 301 22591
R1240	SMDRES 2K15 1% TC100 0805	B4		4022 301 21911
R1241	SMDRES 619K 1% TC50 0805	B4		4022 301 22791
R1246	SMDRES 909K 1% TC50 0805	A4		4022 301 22431
R1249	SMDRES 121K 1% TC100 0805	A4		4022 301 22321
R1250	MTL FILM RST MRS25 1% 487K	A5		2322 156 24874
R1251	MTL FILM RST MRS25 1% 487K	A5		2322 156 24874
R1252	SMDRES 26K1 1% TC50 0805		D5	4022 301 22581
R1253	RES RC12H 0805 1% 1M		D5	4822 117 11948
R1254	SMDRES 3K16 1% TC100 0805		D5	4022 301 21951
R1255	RES RC12H 0805 1% 1M		D5	4822 117 11948
R1256	RES RC12H 0805 1% 1M		D5	4822 117 11948
R1265	SMDRES 1M 1% TC50 0805	A4		4022 301 22441
R1266	RES RC12H 0805 1% 1M	A4		4822 117 11948
R1267	SMDRES 10M 5% TC200 0805	B4		4022 301 22451

Item	Description	Location on Main PCA		Ordering Code
		top	bottom	
R1268	SMDRES 121K 1% TC100 0805	A4		4022 301 22321
R1273	SMDRES 31K6 1% TC100 0805		D4	4022 301 22191
R1282	SMDRES 2K15 1% TC100 0805		D5	4022 301 21911
R1283	SMDRES 12K1 1% TC100 0805	A4		4022 301 22091
R1292	SMDRES 1E 1% TC250 0805		D4	4022 301 21291
R1293	SMDRES 4E64 1% TC250 0805		D4	4022 301 21331
R1294	SMDRES 10E 1% TC100 0805		D4	4022 301 21351
R1295	SMDRES 10E 1% TC100 0805		D4	4022 301 21351
R1296	SMDRES 10E 1% TC100 0805		D4	4022 301 21351
R1297	SMDRES 4E64 1% TC250 0805		D4	4022 301 21331
R1298	SMDRES 4E64 1% TC250 0805		D5	4022 301 21331
R1299	SMDRES 10E 1% TC100 0805		C4	4022 301 21351
R1300	SMDRES 1K 1% TC50 0805	A4		4022 301 21831
R1301	SMDRES 1K 1% TC50 0805	B4		4022 301 21831
R1302	SMDRES 46E4 1% TC100 0805		D4	4022 301 21511
R1303	SMDRES 46E4 1% TC100 0805		C4	4022 301 21511
R1304	SMDRES 464K 1% TC50 0805	B4		4022 301 22651
R1305	SMDRES 31E6 1% TC100 0805	B4		4022 301 21471
R1306	SMDRES 31E6 1% TC100 0805	B4		4022 301 21471
R1307	SMDRES 464K 1% TC50 0805	B4		4022 301 22651
R1308	SMDRES 3K83 1% TC100 0805	C3		4022 301 21971
R1309	SMDRES 1K 1% TC50 0805	C3		4022 301 21831
R1310	SMDRES 56E2 1% TC100 0805	C3		4022 301 21531
R1311	SMDRES 56E2 1% TC100 0805	C3		4022 301 21531
R1312	SMDRES 464E 1% TC100 0805	B4		4022 301 21751
R1313	SMDRES 464E 1% TC100 0805	B4		4022 301 21751
R1314	SMDRES 178E 1% TC100 0805	A4		4022 301 21651
R1315	SMDRES 178E 1% TC100 0805	A4		4022 301 21651
R1316	SMDRES 464K 1% TC50 0805	B4		4022 301 22651
R1317	SMDRES 4E64 1% TC250 0805	B3		4022 301 21331
R1318	SMDRES 4E64 1% TC250 0805	B3		4022 301 21331
R1322	SMDRES 3K16 1% TC25 1206	A4		4022 301 22781
R1323	SMDRES 3K16 1% TC100 0805	A4		4022 301 21951
R1324	SMDRES 3K16 1% TC100 0805	A4		4022 301 21951
R1328	SMDRES 1K 1% TC50 0805		D4	4022 301 21831
R1329	SMDRES 1K 1% TC50 0805		C4	4022 301 21831
R1330	SMDRES 68E1 1% TC100 0805		C4	4022 301 21551
R1331	SMDRES 2K87 1% TC100 0805		B3	4022 301 21941
R1332	SMDRES 3K16 1% TC25 1206		B3	4022 301 22781
R1333	SMDRES 3K16 1% TC100 0805		B3	4022 301 21951
R1334	SMDRES 1K 1% TC50 0805		C3	4022 301 21831
R1335	SMDRES 1K 1% TC50 0805		B3	4022 301 21831
R1336	SMDRES 3K16 1% TC100 0805		B3	4022 301 21951
R1339	SMDRES 7K5 1% TC100 0805		D4	4022 301 22041
R1350	SMDRES 1K 1% TC50 0805	A4		4022 301 21831
R1351	SMDRES 1K 1% TC50 0805	A4		4022 301 21831
R1352	SMDRES 46E4 1% TC100 0805		D3	4022 301 21511
R1353	SMDRES 46E4 1% TC100 0805		D3	4022 301 21511

Item	Description	Location on Main PCA		Ordering Code
		top	bottom	
R1500	MTL FILM RST MRS25 1% 332K	C5		2322 156 13324
R1501	MTL FILM RST MRS25 1% 332K	B5		2322 156 13324
R1502	MTL FILM RST MRS25 1% 332K	B5		2322 156 13324
R1503	SMDRES 3K83 1% TC100 0805	C5		4022 301 21971
R1504	SMDRES 261K 1% TC50 0805	C5		4022 301 22591
R1505	SMDRES 26K1 1% TC50 0805	C4		4022 301 22581
R1506	SMDRES 2K61 1% TC50 0805	C5		4022 301 22571
R1507	SMDRES 261E 1% TC50 0805	C5		4022 301 22561
R1508	SMDRES 3K16 1% TC100 0805	B4		4022 301 21951
R1509	SMDRES 19K6 1% TC50 0805	C4		4022 301 22801
R1510	SMDRES 1K96 1% TC100 0805	B4		4022 301 21901
R1511	SMDRES 100K 1% TC50 0805	C4		4022 301 22311
R1512	SMDRES 1K 1% TC50 0805	C4		4022 301 21831
R1513	SMDRES 2K61 1% TC50 0805	C4		4022 301 22571
R1514	SMDRES 2K15 1% TC100 0805	B4		4022 301 21911
R1515	RES RC12H 0805 1% 1M	B4		4822 117 11948
R1516	SMDRES 2K15 1% TC100 0805	B4		4022 301 21911
R1517	RES RC12H 0805 1% 1M	B4		4822 117 11948
R1518	SMDRES 51K1 1% TC100 0805	B4		4022 301 22241
R1519	SMDRES 1K62 1% TC100 0805	B4		4022 301 21881
R1520	SMDRES 51K1 1% TC100 0805	B4		4022 301 22241
R1521	SMDRES 31K6 1% TC100 0805	C4		4022 301 22191
R1522	SMDRES 2K15 1% TC100 0805	C4		4022 301 21911
R1523	SMDRES 6K19 1% TC50 0805	C4		4022 301 22861
R1524	SMDRES 1K 1% TC50 0805	C4		4022 301 21831
R1525	SMDRES 1K 1% TC50 0805	C4		4022 301 21831
R1526	SMDRES 6K19 1% TC50 0805	C4		4022 301 22861
R1527	SMDRES 100E 1% TC100 0805	C4		4022 301 21591
R1528	SMDRES 1K 1% TC50 0805		B3	4022 301 21831
R1529	SMDRES 6K19 1% TC50 0805		B3	4022 301 22861
R1530	SMDRES 6K19 1% TC50 0805		B3	4022 301 22861
R1531	SMDRES 0E 0805		B3	4022 301 21281
R1532	SMDRES 1K 1% TC50 0805		B3	4022 301 21831
R1533	SMDRES 6K19 1% TC50 0805		B3	4022 301 22861
R1534	SMDRES 1K62 1% TC100 0805	B4		4022 301 21881
R1535	PTC THERM DISC 1000V 1K1	B5		4022 301 22491
R1536	SMDRES 3K16 1% TC100 0805		C5	4022 301 21951
R1537	SMDRES 511E 1% TC100 0805	C5		4022 301 21761
R1538	RES RC12H 0805 1% 100K		B4	4822 117 10837
R1539	RES RC12H 0805 1% 100K	C5		4822 117 10837
R1540	SMDRES 21K5 1% TC50 0805		C5	4022 301 22151
R1541	SMDRES 31K6 1% TC100 0805		C5	4022 301 22191
R1544	SMDRES 6K19 1% TC50 0805		B5	4022 301 22861
R1545	SMDRES 1K 1% TC50 0805	C4		4022 301 21831
R1546	SMDRES 10K 1% TC50 0805	C4		4022 301 22071
R1547	SMDRES 100K 1% TC50 0805	C4		4022 301 22311
R1548	SMDRES 10K 1% TC50 0805	C4		4022 301 22071
R1549	SMDRES 21K5 1% TC50 0805		B4	4022 301 22151

Item	Description	Location on Main PCA		Ordering Code
		top	bottom	
R1550	SMDRES 100K 1% TC50 0805		B4	4022 301 22311
R1551	SMDRES 21K5 1% TC50 0805		B5	4022 301 22151
R1555	SMDRES 31K6 1% TC100 0805		B5	4022 301 22191
R1556	SMDRES 100K 1% TC50 0805	C5		4022 301 22311
R1557	SMDRES 9K09 1% TC50 0805	C5		4022 301 22671
R1558	SMDRES 1M 1% TC50 0805	C5		4022 301 22441
R1559	SMDRES 1M 1% TC50 0805	C5		4022 301 22441
R1560	SMDRES 1M 1% TC50 0805	C5		4022 301 22441
R1561	SMDRES 2K61 1% TC50 0805		B5	4022 301 22571
R1562	SMDRES 26K1 1% TC50 0805		B5	4022 301 22581
R1563	SMDRES 261K 1% TC50 0805		B5	4022 301 22591
R1564	SMDRES 1M 1% TC50 0805	C5		4022 301 22441
R1565	SMDRES 1M 1% TC50 0805	C5		4022 301 22441
R1566	SMDRES 619K 1% TC50 0805	C5		4022 301 22791
R1570	RES RC12H 0805 1% 1M		B4	4822 117 11948
R1575	SMDRES 100E 1% TC100 0805		C4	4022 301 21591
R1580	SMDRES 1K47 1% TC100 0805	B4		4022 301 21871
R1581	SMDRES 1K47 1% TC100 0805	B4		4022 301 21871
R1582	SMDRES 46E4 1% TC100 0805	B3		4022 301 21511
R1583	SMDRES 46E4 1% TC100 0805	B3		4022 301 21511
R2003	SMDRES 51K1 1% TC100 0805		C3	4022 301 22241
R2004	SMDRES 51K1 1% TC100 0805		C3	4022 301 22241
R2005	SMDRES 51K1 1% TC100 0805		C3	4022 301 22241
R2006	SMDRES 51K1 1% TC100 0805		C3	4022 301 22241
R2007	SMDRES 511E 1% TC100 0805		B2	4022 301 21761
R2008	SMDRES 51K1 1% TC100 0805		B2	4022 301 22241
R2015	SMDRES 82K5 1% TC100 0805		C3	4022 301 22291
R2016	SMDRES 82K5 1% TC100 0805		C3	4022 301 22291
R2017	SMDRES 82K5 1% TC100 0805		C3	4022 301 22291
R2018	SMDRES 82K5 1% TC100 0805		C3	4022 301 22291
R2020	SMDRES 287K 1% TC100 0805	B2		4022 301 24681
R2021	RES RC12H 0805 1% 1M	B2		4822 117 11948
R2022	SMDRES 681K 1% TC100 0805	B2		4022 301 22411
R2023	SMDRES 13K3 1% TC100 0805	B2		4022 301 22101
R2024	SMDRES 14K7 1% TC100 0805	B2		4022 301 22111
R2025	SMDRES 14K7 1% TC100 0805	B2		4022 301 22111
R2027	SMDRES 10K 1% MIX 0805		B2	4022 301 23091
R2028	SMDRES 10K 1% MIX 0805		B1	4022 301 23091
R2030	SMDRES 10K 1% MIX 0805		B1	4022 301 23091
R2031	SMDRES 51K1 1% TC100 0805		B1	4022 301 22241
R2032	SMDRES 51K1 1% TC100 0805		B1	4022 301 22241
R2033	SMDRES 10K 1% MIX 0805		B2	4022 301 23091
R2034	SMDRES 1K 1% TC50 0805		B2	4022 301 21831
R2035	SMDRES 100E 1% TC100 0805	B2		4022 301 21591
R2037	SMDRES 10E 1% TC100 0805		B2	4022 301 21351
R2049	SMDRES 1K47 1% TC100 0805		A2	4022 301 21871
R2050	SMDRES 1K 1% TC50 0805		B2	4022 301 21831
R2051	SMDRES 100E 1% TC100 0805	C2		4022 301 21591

Item	Description	Location on Main PCA		Ordering Code
		top	bottom	
R2052	SMDRES 17K8 1% TC100 0805		B2	4022 301 22131
R2053	SMDRES 422E 1% TC100 0805		B2	4022 301 21741
R2058	SMDRES 100K 1% TC50 0805		A1	4022 301 22311
R2060	RES RC12H 0805 1% 1M	B2		4822 117 11948
R2061	SMDRES 383K 1% TC100 0805	B2		4022 301 22381
R2062	SMDRES 42K2 1% TC100 0805		B3	4022 301 22221
R2063	SMDRES 178K 1% TC100 0805	B2		4022 301 22341
R2202	SMDRES 1E 1% TC250 0805		B2	4022 301 21291
R2204	SMDRES 1E 1% TC250 0805		B2	4022 301 21291
R2210	SMDRES 1E 1% TC250 0805		B3	4022 301 21291
R2213	SMDRES 1E 1% TC250 0805		B3	4022 301 21291
R2214	SMDRES 1E 1% TC250 0805		B2	4022 301 21291
R2220	SMDRES 1E 1% TC250 0805		B2	4022 301 21291
R2221	SMDRES 1E 1% TC250 0805		B2	4022 301 21291
R2222	SMDRES 1E 1% TC250 0805		C2	4022 301 21291
R2232	SMDRES 1E 1% TC250 0805		C3	4022 301 21291
R2233	SMDRES 1E 1% TC250 0805		B2	4022 301 21291
R2240	SMDRES 2K15 1% TC100 0805		B2	4022 301 21911
R2242	SMDRES 2K15 1% TC100 0805		B2	4022 301 21911
R2252	SMDRES 1E 1% TC250 0805		B2	4022 301 21291
R2253	SMDRES 1E 1% TC250 0805		B2	4022 301 21291
R2254	SMDRES 1E 1% TC250 0805		B3	4022 301 21291
R2260	SMDRES 1E 1% TC250 0805		B3	4022 301 21291
R2261	SMDRES 1E 1% TC250 0805		B2	4022 301 21291
R2262	SMDRES 1E 1% TC250 0805		B2	4022 301 21291
R2263	SMDRES 1E 1% TC250 0805		B2	4022 301 21291
R2264	SMDRES 1E 1% TC250 0805		B2	4022 301 21291
R2270	SMDRES 1E 1% TC250 0805	B3		4022 301 21291
R2272	SMDRES 1E 1% TC250 0805		B2	4022 301 21291
R2273	SMDRES 1E 1% TC250 0805		B2	4022 301 21291
R2280	SMDRES 1E 1% TC250 0805		B3	4022 301 21291
R2282	SMDRES 1E 1% TC250 0805		B2	4022 301 21291
R2283	SMDRES 1E 1% TC250 0805		B2	4022 301 21291
R2284	SMDRES 1E 1% TC250 0805		B2	4022 301 21291
R2291	SMDRES 1E 1% TC250 0805		C2	4022 301 21291
R3000	SMDRES 21K5 1% TC50 0805		B2	4022 301 22151
R3001	SMDRES 1E 1% TC250 0805		C2	4022 301 21291
R3002	SMDRES 1E 1% TC250 0805		C2	4022 301 21291
R3003	SMDRES 1E 1% TC250 0805		C2	4022 301 21291
R3010	SMDRES 1E 1% TC250 0805		B2	4022 301 21291
R3011	SMDRES 1E 1% TC250 0805		B2	4022 301 21291
R3050	SMDRES 10K 1% TC50 0805		B2	4022 301 23091
R3051	SMDRES 10K 1% TC50 0805		B2	4022 301 23091
R3100	SMDRES 21K5 1% TC50 0805		C2	4022 301 22151
R3102	SMDRES 1E 1% TC250 0805		C2	4022 301 21291
R3103	SMDRES 1E 1% TC250 0805		C2	4022 301 21291
R3110	SMDRES 1E 1% TC250 0805		C2	4022 301 21291
R3111	SMDRES 1E 1% TC250 0805		C2	4022 301 21291

Item	Description	Location on Main PCA		Ordering Code
		top	bottom	
R3200	SMDRES 0E 0805		C2	4022 301 21281
R3300	SMDRES 147K 1% TC50 0805		B1	4022 301 22331
R3301	SMDRES 147K 1% TC50 0805		B1	4022 301 22331
R3302	SMDRES 147K 1% TC50 0805		B1	4022 301 22331
R3303	SMDRES 42K2 1% TC100 0805		B2	4022 301 22221
R3304	SMDRES 42K2 1% TC100 0805		B1	4022 301 22221
R3310	SMDRES 147K 1% TC50 0805		B1	4022 301 22331
R3311	SMDRES 26K1 1% TC50 0805		B1	4022 301 22581
R3312	SMDRES 3K16 1% TC100 0805		B1	4022 301 21951
R3313	SMDRES 1K47 1% TC100 0805		B1	4022 301 21871
R3400	SMDRES 162E 1% TC100 0805	A2		4022 301 21641
R3401	SMDRES 10E 1% TC100 0805	A2		4022 301 21351
R3402	SMDRES 14K7 1% TC100 0805		D2	4022 301 22111
R3403	SMDRES 511E 1% TC100 0805	A2		4022 301 21761
R3404	SMDRES 511E 1% TC100 0805	A2		4022 301 21761
R3405	RES RC12H 0805 1% 100K	A2		4822 117 10837
R3406	SMDRES 4K64 1% TC100 0805	A2		4022 301 21991
R3407	SMDRES 100E 1% TC100 0805	B1		4022 301 21591
R3408	SMDRES 14K7 1% TC100 0805		D2	4022 301 22111
R3409	SMDRES 21K5 1% TC50 0805	A2		4022 301 22151
R3500	SMDRES 0E 0805	B1		4022 301 21281
R3501	RES RC12H 0805 1% 10K		C2	4022 301 61331
R3502	SMDRES 1K 1% TC50 0805	D1		4022 301 21831
R3503	RES RC12H 0805 1% 100K	D1		4822 117 10837
R3504	RES RC12H 0805 1% 100K	D1		4822 117 10837
R3505	RES RC12H 0805 1% 42K2		C1	4022 301 22221
R3507	SMDRES 1K 1% TC50 0805		C1	4022 301 21831
R3510	SMDRES 10K 1% MIX 0805		B2	4022 301 23091
R3511	SMDRES 100E 1% TC100 0805	B1		4022 301 21591
R3512	SMDRES 100E 1% TC100 0805	B1		4022 301 21591
R3520	SMDRES 0E 0805	C1		4022 301 21281
R3522	SMDRES 0E 0805	C1		4022 301 21281
R3523	SMDRES 3K16 1% TC100 0805		C3	4022 301 21951
R3524	SMDRES 3K16 1% TC100 0805		C3	4022 301 21951
R3530	RES RC12H 0805 1% 1M		C1	4822 117 11948
R3531	SMDRES 82E5 1% TC100 0805		C1	4022 301 21571
R3532	SMDRES 511E 1% TC100 0805		C1	4022 301 21761
R3533	RES RC12H 0805 1% 1M		C1	4822 117 11948
R3542	SMDRES 0E 0805		C1	4022 301 21281
R3551	SMDRES 100K 1% TC50 0805		C1	4022 301 22311
R3552	SMDRES 10K 1% TC50 0805		C1	4022 301 23091
R3554	SMDRES 1M 1206		C1	4022 301 21231
R3555	SMDRES 10K 1% TC50 0805		B1	4022 301 23091
R3601	SMDRES 10E 1% TC100 0805	D3		4022 301 21351
R3603	RES RC12H 0805 1% 100K		A1	4822 117 10837
R3604	SMDRES 23K7 1% TC100 0805		A1	4022 301 22161
R3606	SMDRES 38K3 1% TC100 0805		A1	4022 301 22211
R3607	SMDRES 42K2 1% TC100 0805		A1	4022 301 22221

Item	Description	Location on Main PCA		Ordering Code
		top	bottom	
R3608	SMDRES 215K 1% TC50 0805		A1	4022 301 22351
R3609	SMDRES 14E7 1% TC100 0805		A2	4022 301 21391
R3611	SMDRES 6K81 1% TC100 0805		A1	4022 301 22031
R3612	SMDRES 6K81 1% TC100 0805		A2	4022 301 22031
R3613	SMDRES 82K5 1% TC100 0805		A2	4022 301 22291
R3614	SMDRES 6K81 1% TC100 0805		A2	4022 301 22031
R3615	SMDRES 6K81 1% TC100 0805		A2	4022 301 22031
R3621	SMDRES 14E7 1% TC100 0805		A3	4022 301 21391
R3622	SMDRES 14E7 1% TC100 0805		A3	4022 301 21391
R3623	SMDRES 14E7 1% TC100 0805		A3	4022 301 21391
R3624	SMDRES 14E7 1% TC100 0805		A2	4022 301 21391
R3631	SMDRES 14E7 1% TC100 0805		A3	4022 301 21391
R3632	SMDRES 14E7 1% TC100 0805		A3	4022 301 21391
R3633	SMDRES 14E7 1% TC100 0805		A3	4022 301 21391
R3634	SMDRES 14E7 1% TC100 0805		A2	4022 301 21391
R4000	SMDRES .33E 5% TC700 1206	A1		4022 301 21261
R4001	RES RC12H 0805 1% 100K	A2		4822 117 10837
R4002	SMDRES 100E 1% TC100 0805		D2	4022 301 21591
R4003	SMDRES 0.1E 5% TC999 1206		C2	4022 301 21251
R4010	SMDRES 10E 1% TC100 0805		C1	4022 301 21351
R4011	SMDRES 237E 1% TC100 0805		D2	4022 301 21681
R4012	SMDRES 3K83 1% TC100 0805		D2	4022 301 21971
R4013	SMDRES 2K15 1% TC100 0805		D2	4022 301 21911
R4014	SMDRES 38K3 1% TC100 0805		D2	4022 301 22211
R4020	SMDRES 12K1 1% TC100 0805		D2	4022 301 22091
R4021	SMDRES 34K8 1% TC100 0805		D1	4022 301 22201
R4022	SMDRES 51K1 1% TC100 0805		D2	4022 301 22241
R4023	SMDRES 100E 1% TC100 0805	A2		4022 301 21591
R4024	SMDRES 10E 1% TC100 0805		D2	4022 301 21351
R4025	SMDRES 10K 1% MIX 0805		D1	4022 301 23091
R4100	SMDRES 10K 1% MIX 0805		D1	4022 301 23091
R4101	SMDRES 0E15 1% TC75 2010	B1		4022 301 22471
R4102	SMDRES 2K87 1% TC100 0805		D1	4022 301 21941
R4103	SMDRES 46E4 1% TC100 0805		D1	4022 301 21511
R4104	SMDRES 0.1E 5% TC999 1206		D1	4022 301 21251
R4110	SMDRES 10E 1% TC100 0805	A1		4022 301 21351
R4112	SMDRES 10E 1% TC100 0805		D2	4022 301 21351
R4113	SMDRES 38K3 1% TC100 0805		D1	4022 301 22211
R4114	SMDRES 8K25 1% TC100 0805		D1	4022 301 22051
R4120	SMDRES 34K8 1% TC100 0805		D1	4022 301 22201
R4121	SMDRES 1K47 1% TC100 0805		D1	4022 301 21871
R4122	RES RC12H 0805 1% 100K		D1	4822 117 10837
R4123	RES RC12H 0805 1% 100K		D2	4822 117 10837
R4124	RES RC12H 0805 1% 100K		D2	4822 117 10837
R4130	RES RC12H 0805 1% 1M		D1	4822 117 11948
R4200	SMDRES 10K 1% MIX 0805		A3	4022 301 23091
R4201	RES RC12H 0805 1% 100K	D2		4822 117 10837
R4202	SMDRES 5K11 1% TC100 0805		A2	4022 301 22001

Item	Description	Location on Main PCA		Ordering Code
		top	bottom	
R4203	SMDRES 1K 1% TC50 0805		A2	4022 301 21831
R4204	SMDRES 4E64 1% TC100 0805		A2	4022 301 21511
R4205	SMDRES 4E64 1% TC250 0805	D2		4022 301 21331
R4206	SMDRES 10K 1% MIX 0805	D2		4022 301 23091
R4207	SMDRES 6K19 1% TC50 0805		A2	4022 301 22861
R4208	SMDRES 10K 1% MIX 0805		A2	4022 301 23091
R4300	SMDRES 21K5 1% TC50 0805	B1		4022 301 22151
R4301	RES RC12H 0805 1% 100K		D1	4822 117 10837
R4302	SMDRES 42K2 1% TC100 0805		D1	4022 301 22221
R4303	SMDRES 100E 1% TC100 0805		D1	4022 301 21591
R4304	RES RC12H 0805 1% 100K (OLD)		D1	4822 117 10837
	RES RC12H 0805 1% 82K5 (NEW)		D1	4022 301 22291
R4305	SMDRES 42K2 1% TC100 0805 (OLD)		D1	4022 301 22221
	SMDRES 61K9 1% TC100 0805 (NEW)		D1	4022 301 22851
R4306	SMDRES 2K15 1% TC100 0805		D1	4022 301 21911
T1100	K20 FLOAT SIGNAL TRANSF.	C3		4022 301 92221
T1102	EF16 FLOAT POWER TRANSF.	D3		4022 301 92211
T1300	K20 FLOAT SIGNAL TRANSF.	B3		4022 301 92221
T1302	EF16 FLOAT POWER TRANSF.	A3		4022 301 92211
T1575	EF16 FLOAT POWER TRANSF.	C3		4022 301 92211
T4001	FLYBACK TRANSF.	B2		4022 301 92361
T4200	SMD TRANSF. 678XN-1081	D2		5322 146 10634
V1004	PNP/NPN TR.PAIR BCV65		A4	5322 130 10762
V1009	PREC.VOLT.REF. LM4041CIM3X-1.2		A4	4022 304 10571
V1100	SWITCH DIODE BAV99	C4		5322 130 34337
V1101	SWITCH DIODE BAV99	D4		5322 130 34337
V1102	SWITCH DIODE BAV99		A3	5322 130 34337
V1103	SWITCH DIODE BAV99		A3	5322 130 34337
V1104	SWITCH DIODE BAV99		B4	5322 130 34337
V1105	SWITCH DIODE BAV99		A4	5322 130 34337
V1106	HF TRANSISTOR BFR92A	C4		9335 515 60215
V1120	LF TRANSISTOR BC848CLT1		B4	4022 304 11011
V1150	LF TRANSISTOR BC848CLT1		A4	4022 304 11011
V1151	LF TRANSISTOR BC848CLT1		A4	4022 304 11011
V1152	SCHOTTKY DIODE BAT74	D4		9337 422 90215
V1160	SCHOTTKY DIODE MBRS1100T3		A4	5322 130 10675
V1161	SCHOTTKY DIODE MBRS340T3		A4	5322 130 10674
V1162	SCHOTTKY DIODE MBRS340T3		A4	5322 130 10674
V1204	PNP/NPN TR.PAIR BCV65		D4	5322 130 10762
V1209	PREC.VOLT.REF. LM4041CIM3X-1.2		D4	4022 304 10571
V1300	SWITCH DIODE BAV99	A4		5322 130 34337
V1301	SWITCH DIODE BAV99	B4		5322 130 34337
V1302	SWITCH DIODE BAV99		C3	5322 130 34337
V1303	SWITCH DIODE BAV99		C3	5322 130 34337
V1304	SWITCH DIODE BAV99		D4	5322 130 34337
V1305	SWITCH DIODE BAV99		C4	5322 130 34337

Item	Description	Location on Main PCA		Ordering Code
		top	bottom	
V1306	HF TRANSISTOR BFR92A	B4		9335 515 60215
V1320	LF TRANSISTOR BC848CLT1		C4	4022 304 11011
V1350	LF TRANSISTOR BC848CLT1		D4	4022 304 11011
V1351	LF TRANSISTOR BC848CLT1		D4	4022 304 11011
V1352	SCHOTTKY DIODE BAT74	A4		9337 422 90215
V1360	SCHOTTKY DIODE MBRS1100T3		D4	5322 130 10675
V1361	SCHOTTKY DIODE MBRS340T3		D4	5322 130 10674
V1362	SCHOTTKY DIODE MBRS340T3		D4	5322 130 10674
V1515	SWITCH DIODE BAV99	B4		5322 130 34337
V1516	SWITCH DIODE BAV99	B4		5322 130 34337
V1525	LF TRANSISTOR BC848CLT1	C4		4022 304 11011
V1535	LF TRANSISTOR BC868		C5	9336 787 70115
V1536	LF TRANSISTOR BC868		C5	9336 787 70115
V1537	VOLT REG DIODE BZD27-C7V5		C5	9338 674 50115
V1544	P-CHAN FET SST270	C5		4022 304 10541
V1545	SWITCH DIODE BAV99	C4		5322 130 34337
V1550	PREC.VOLT.REF. LM4041CIM3X-1.2		B5	4022 304 10571
V1555	PREC.VOLT.REF. LM4041CIM3X-1.2		B5	4022 304 10571
V1560	P-CHAN FET SST270 SLX	C5		4022 304 10541
V1575	SCHOTTKY DIODE MBRS1100T3		C4	5322 130 10675
V1576	SCHOTTKY DIODE MBRS1100T3		B4	5322 130 10675
V1580	LF TRANSISTOR BC848CLT1	B4		4022 304 11011
V1581	LF TRANSISTOR BC848CLT1	B4		4022 304 11011
V1582	SCHOTTKY DIODE BAT74	B4		9337 422 90215
V1583	LF TRANSISTOR BC858C		C3	4022 304 11021
V1584	LF TRANSISTOR BC858C		C3	4022 304 11021
V2000	LF TRANSISTOR BC858C	B2		4022 304 11021
V2001	LF TRANSISTOR BC858C	B2		4022 304 11021
V2002	SCHOTTKY DIODE BAS85		B2	9338 765 40115
V3401	SCHOTTKY DIODE BAS28	A2		5322 130 80214
V3402	SCHOTTKY DIODE BAT74	A3		9337 422 90215
V3500	SCHOTTKY DIODE BAT74	B1		9337 422 90215
V4000	LF TRANSISTOR BC869	A2		9336 787 80115
V4001	N-CHANN FET NDC651N		C2	4022 304 10341
V4004	RECT DIODE BYD77D		D2	9338 123 60115
V4005	SCHOTTKY DIODE MBRS340T3		D2	5322 130 10674
V4011	SCHOTTKY DIODE MBRS340T3		D3	5322 130 10674
V4012	SCHOTTKY DIODE MBRS340T3		D3	5322 130 10674
V4013	SCHOTTKY DIODE MBRS340T3		D3	5322 130 10674
V4014	RECT DIODE BYD77D		D2	9338 123 60115
V4015	SCHOTTKY DIODE MBRS1100T3		D2	5322 130 10675
V4025	RECT DIODE BYD77D		D2	9338 123 60115
V4100	SCHOTTKY DIODE MBRS340T3		D1	5322 130 10674
V4101	SCHOTTKY DIODE MBRS340T3		D1	5322 130 10674
V4102	POWER TMOS FET MTD5P06ET4		C1	5322 130 10671
V4104	SIL DIODE BAS16		D1	5322 130 31928
V4105	DUAL SCH.DIODE 6A 60V D-PAK		C1	4022 304 11241
V4110	VOLT REG DIODE BZX84-B7V5		D1	9336 960 10215

Item	Description	Location on Main PCA		Ordering Code
		top	bottom	
V4111	LF TRANSISTOR BC848CLT1		D2	4022 304 11011
V4112	LF TRANSISTOR BC848CLT1		D2	4022 304 11011
V4114	PREC.VOLT.REF. LM4041CIM3X-1.2		D2	4022 304 10571
V4200	TMOS P-CH FET MTSF2P03HD	D2		4022 304 11591
V4201	TMOS N-CH FET MMDF3N04HD		A3	4022 304 10221
V4202	SCHOTTKY DIODE MBRS1100T3		A3	5322 130 10675
V4203	SIL DIODE BAS16	D2		5322 130 31928
V4204	LF TRANSISTOR BC858C	D3		4022 304 11021
V4205	PTC SILICON TEMP SENSOR 2K 1%		C2	0019 103 00121
V4210	N-CHAN FET BSN20		A3	9340 125 00215
V4211	N-CHAN FET BSN20		D3	9340 125 00215
X3501	FLASH/SRAM MODULE CONNECTOR	D1		0016 105 00041
X3600	KEYBOARD CONNECTOR 15-P	D1		5322 265 10725
X3601	DISPLAY CONNECTOR 22-P	D3		4022 303 10571
X4000	FAN CONNECTOR 2-P		C2	4022 303 10561
X4100	BATTERY CONNECTOR 4-P	B1		4022 303 10071
X4101	POWER ADAPTER CONNECTOR	A5		4022 244 92561
X4200	BACKLIGHT CONNECTOR 2-P	D2		4022 303 10581
Z4100	EMI-FILTER 50V 10A	A1		5322 156 11139

8.7 Accessories

Table 8-4. Standard Accessories

Item	Ordering Code
Battery Charger, available models: Universal Europe 230 V, 50 and 60 Hz North America 120 V, 50 and 60 Hz United Kingdom 240 V, 50 and 60 Hz Japan 100 V, 50 and 60 Hz Australia 240 V, 50 and 60 Hz Universal 115 V/230 V, 50 and 60 Hz <i>The universal adapter is standard equipped with a plug EN60320-2.2G. For connection to the mains outlet use a line plug that complies with National Standards. The 230V rating of the BC190/808 is not for use in North America.</i>	BC190/801 BC190/803 BC190/804 BC190/806 BC190/807 BC190/808
Voltage Probe Set (Red), designed for use with the Fluke ScopeMeter 190 series test tool. The set includes the following items (not available separately): <ul style="list-style-type: none"> • 10:1 Voltage Probe (red) • 4-mm Test Probe for Probe Tip (red) • Hook Clip for Probe Tip (red) • Ground Lead with Hook Clip (red) • Ground Lead with Mini Alligator Clip (black) • Ground Spring for Probe Tip (black) 	VP200-R
Voltage Probe Set (Gray), designed for use with the Fluke ScopeMeter 190 series test tool. The set includes the following items (not available separately): <ul style="list-style-type: none"> • 10:1 Voltage Probe (gray) • 4-mm Test Probe for Probe Tip (gray) • Hook Clip for Probe Tip (gray) • Ground Lead with Hook Clip (gray) • Ground Lead with Mini Alligator Clip (black) 	VP200-G
Test Lead Set	TL75
Accessory Set (Red) The set includes the following items (not available separately): <ul style="list-style-type: none"> • Industrial Alligator for Probe Tip (red) • 2-mm Test Probe for Probe Tip (red) • Industrial Alligator for Banana Jack (red) • 2-mm Test Probe for Banana Jack (red) • Ground Lead with 4-mm Banana Jack (black) 	AS200-R
Accessory Set (Gray) The set includes the following items (not available separately): <ul style="list-style-type: none"> • Industrial Alligator for Probe Tip (gray) • 2-mm Test Probe for Probe Tip (gray) • Industrial Alligator for Banana Jack (gray) • 2-mm Test Probe for Banana Jack (gray) • Ground Lead with 4-mm Banana Jack (black) 	AS200-G

Table 8-5. Standard Accessories (continued)

Item	Ordering Code
Replacement Set for Voltage Probe VP200 The set includes the following items (not available separately): <ul style="list-style-type: none"> • 2x , 4-mm Test Probe for Probe Tip (red and gray) • 3x , Hook Clip for Probe Tip (2 red, 1 gray) • 2x , Ground Lead with Hook Clip (red and gray) • 2x , Ground Lead with Mini Alligator Clip (black) • 5x Ground Spring for Probe Tip (black) 	RS200

Table 8-6. Users Manuals

Item	Ordering Code
Getting Started Manual (English)	4822 872 30701
Getting Started Manual (German)	4822 872 30702
Getting Started Manual (French)	4822 872 30703
Getting Started Manual (Spanish)	4822 872 30704
Getting Started Manual (Portuguese)	4822 872 30705
Getting Started Manual (Italian)	4822 872 30706
Getting Started Manual (Chinese)	4822 872 30707
Getting Started Manual (Japanese)	4822 872 30708
Getting Started Manual (Korean)	4822 872 30709
CD with Users Manuals (English, German, French, Spanish, Portuguese, Italian, Chinese, Japanese, Korean)	4022 240 12370

Table 8-7. Optional Accessories

Item	Ordering Code
Software & Cable Carrying Case Kit Set contains the following parts: <ul style="list-style-type: none"> • Optically Isolated RS-232 Adapter/Cable • Hard Carrying Case • FlukeView™ ScopeMeter Software for Windows 95®, 98®, Me®, 2000® and NT4® 	SCC190 PM9080 C190 SW90W
Optically Isolated RS-232 Adapter/Cable	PM9080
Hard Case	C190
Soft Case	C195
Current Shunt 4-20 mA	CS20MA
Print Adapter Cable for Parallel Printers	PAC91



Chapter 9

Circuit Diagrams

Title	Page
9.1 Introduction	9-3
9.2 Tracing signals in circuit diagrams	9-3
9.3 Locating Parts & Test Points	9-3
9.4 Diagrams	9-6

9.1 Introduction

This chapter contains all circuit diagrams and reference designator views of the test tool. There are no serviceable parts on the LCD unit. Therefore no circuit diagrams and reference designator views of the LCD unit are provided.

9.2 Tracing signals in circuit diagrams

Signal lines ending with an arrowhead indicate that the signal goes from one circuit diagram to another. To trace these signals, you can use the coordinates on the edges of the diagrams and Table 9-1, see the example below.

For example:

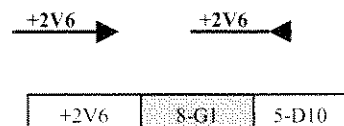

indicates that signal +2V6 goes from circuit diagram Figure 9-8 location G1, to circuit diagram Figure 9-5 location D10.

The shaded cells in Table 9-1 show the source location of the signal

9.3 Locating Parts & Test Points

Note:

Capacitors of 0 pF, and resistors of 100 MΩ shown in circuit diagrams are not placed on the PCA. They are drawn in the circuit diagrams for PCA layout purposes. In the layout design process they create locations on the PCA where capacitors or resistors can be placed.

Use Table 8-3 (Chapter 8) to locate parts on the reference designator views of the Main PCA Top View (Figure 9-12, 9-14) and Bottom View (Figure 9-11, 9-13). The drawings are provided with coordinates at the edges.

Use Table 9-2 to locate test points (Mxxxx) on the PCA Top Side indicated in Figure 9-11 or Figure 9-13.

Table 9-1. Source & Destination of Signals

+2V6	9-D1	5-B5
+30V	9-C1	7-A2
		8-D5
+3V3GAR	9-D1	7-A5
		10-A3
+3V3SADC	9-A2	10-B5
		10-B3
+3V45	9-D1	1-B1
	2-B1	3-A1
		5-D5
		6-A3
		6-A5
		10-C5
+3V45J	5-D4	1-D1
		2-D1
		4-D3
		4-A5
+5V2	9-D1	4-D1
		4-A2
		8-C5
		10-C5
+VD	7-A4	4-D5
	7-A2	8-B4
-1V8	9-C1	5-D3
-1V8J	5-D1	1-D1
		2-D1
		4-A5
ADC A	4-D1	6-D5
		6-C3
ADC-A-D(0:7)	6-C3	7-D5
	6-C1	
ADC B	4-B1	6-B3
		6-B5
ADC-B-D(0:7)	6-B3	7-B5
	6-A1	
ALLTRIG	4-B1	5-A5
		7-C5
BACKBRIG	7-C5	10-C5
BATCUR	9-A2	10-B5
BATIDENT	9-D4	7-B5
		10-B5
BATTEMP	9-A2	10-B5
CHARCUR	7-B5	9-A2
CLKJILL	7-C5	4-C1
COLOR#	7-A2	8-B1
CONTRAST	7-B5	8-D5
DATACLK	7-C2	8-B1
DISPON	7-C2	8-B1
ENSHPULS	7-A2	5-A5

EXTTRIG	4-B1	7-C5
FLTPOWIN1	9-C1	1-A1
	2-A1	3-B1
FLTPOWIN2	9-C1	1-A1
	2-A1	3-B1
FRAME	7-C2	8-B1
FREQPS	9-A2	7-A3
HFA1	1-D1	4-C3
HFA2	1-D1	4-C3
HFB1	2-D1	4-C3
HFB2	2-D1	4-C3
HOLDOFF	7-C5	4-A1
INTRP	4-D1	7-C5
LCDDATA(0:7)	7-C2	8-A1
LFA1	1-C1	4-D3
LFA2	1-C1	4-D3
LFB1	2-C1	4-C3
LFB2	2-C1	4-C3
LINECLK	7-C2	8-B1
LFEXT1	3-C1	4-C3
LFEXT2	3-C1	4-C3
		4-A5
LINTAB	7-A3	4-A5
MAINVAL	9-A2	7-A3
M ENAB	7-C2	8-B1
MIDADC	6-C5	4-D1
	6-C3	
OFFSETAD	7-C5	4-A5
PWRON	7-A3	4-C5
		9-A2
RAMPCLK	7-C5	4-C1
REFADCT	4-D1	4-A5
	5-A2	6-D5
	6-C3	10-B5
REFPWM1	4-C1	7-C5
		8-D5
REFPWM2	9-A2	7-B5
RLFA1	1-C1	4-D3
RLFA2	1-C1	4-D3
RLFB1	2-C1	4-B3

RLFB2	2-C1	4-B3
RLFEXT1	3-C1	4-C3
RLFEXT2	3-D1	4-C3
RSTRAMP	7-C5	4-B1
ROMA(0:6)	7-D2	4-D5
ROMCS5#	7-D3	4-C5
ROMD(24:31)	7-D1	4-C5
ROMRD#	7-D3	4-C5
ROMWR#	7-D3	4-B5
ROMWRDL	4-B5	7-D1
RXD1	10-B1	7-A3
SADCLEV	7-B5	10-A5
SCLK	7-B5	4-B5
SCLKEXT	7-A3	3-A1
SCLKFLT	4-B5	1-B1
		2-B1
SDAT	7-B5	4-A5
SDATEXT	7-A3	3-A1
SDATFLT	4-A5	1-B1
		2-B1
SELMUX0	7-A3	10-A5
SELMUX1	7-A3	10-A5
SELMUX2	7-A3	10-A5
SLOWADC	10-B3	7-B5
SMPCLKA	7-D5	6-C3
		6-C5
SMPCLKB	7-B5	6-A3
		6-B5
TLON	7-A2	10-C5
TRGLEV1A	7-C5	4-A3
TRGLEV1B	7-C5	4-A3
TRGLEV2A	7-C5	4-A3
TRGLEV2B	7-B5	4-B3
TRIGDT	4-B1	7-C5
TRIGQUAL	7-C5	5-A5
		4-B1
TRIGQUALJ	5-A5	4-B1
TXD1	7-A3	10-A3
VIP5TOA	5-A1	7-C5
VIP5TOB	5-A1	7-C5
VBAT	9-D1	10-A5
		10-D5
VDDVAL	9-D1	7-A2

Table 9-2. Location of Test Points on PCA Top Side

M1008	D4
M1010	D4
M1011	D4
M1012	D3
M1013	D4
M1014	C3
M1015	D4
M1016	D4
M1017	D3
M1018	D4
M1019	D4
M1020	C4
M1021	D4
M1022	D4
M1023	C3
M1024	C4
M1025	D4
M1026	C3
M1027	C4
M1028	C4
M1029	C4
M1030	D4
M1031	D4
M1032	D4
M1033	D4
M1034	D4
M1035	D4
M1036	D4
M1038	C5

M1100	C3
M1101	C3
M1102	C3
M1103	C3
M1104	C4
M1208	A4
M1209	A4
M1210	A4
M1211	A4
M1212	A4
M1213	A4
M1214	A4
M1215	A4
M1216	A4
M1217	A4
M1218	A4
M1219	A4
M1220	A4
M1221	A4
M1222	A4
M1223	A3
M1224	B4
M1225	B4
M1226	A4
M1227	A4
M1228	A4
M1229	A4
M1230	A4
M1231	A4

M1232	A4
M1233	A4
M1234	A4
M1235	A4
M1236	A4
M1238	B5
M1300	C3
M1301	C3
M1302	C3
M1303	C3
M1304	A4
M1500	C3
M1501	C3
M1502	C3
M1503	C3
M1504	C4
M2000	C2
M2001	C2
M2002	C2
M2003	A3
M2004	A3
M2006	C2
M2008	C2
M2010	B3
M2011	B3
M2012	B3
M2013	B3
M2014	B3
M2021	B2

M2022	B2
M2036	C2
M2053	C2
M2200	B3
M2232	B2
M2250	B2
M2270	B3
M3000	B1
M3001	B2
M3002	B1
M3003	C2
M3100	B2
M3101	B2
M3201	B2
M3202	B2
M3400	A2
M3401	A2
M3500	A3
M3501	B2
M3502	B1
M3503	C1
M3504	B1
M3505	B1
M3506	B1
M3507	C1
M3508	C2
M4000	A2
M4100	B1
M4101	A2

M4105	B1
M4106	B1
M4107	B1
M4200	D2
M4201	D2
M4202	D2
M4203	D2
M4204	D3
M4210	D3
M4211	D2
M4212	D2
M4213	D3
M4300	A1
M4301	A1
M4302	A1
M4303	A1
M4304	A1
M4305	B1
MS...	D1
	D2
	D3



































9.4 Diagrams

See next pages for circuit diagrams and PCB layout drawings.

The table below shows the row/column matrix of the keypad. The keypad is connected to the D-ASIC via X3600 (Figure 9-7)

The On/Off key is not included in the keyboard layout matrix. It is directly connected to an input of the D-ASIC (ONKEY , pin F4)

Table 9-3. Keyboard Layout

	ROW →	0	1	2	3	4	5
COL ↓	test spot	MS3602	MS3603	MS3604	MS3605	MS3606	MS3607
0	MS3608						
1	MS3609						
2	MS3610						
3	MS3611						
4	MS3612						
5	MS3613						

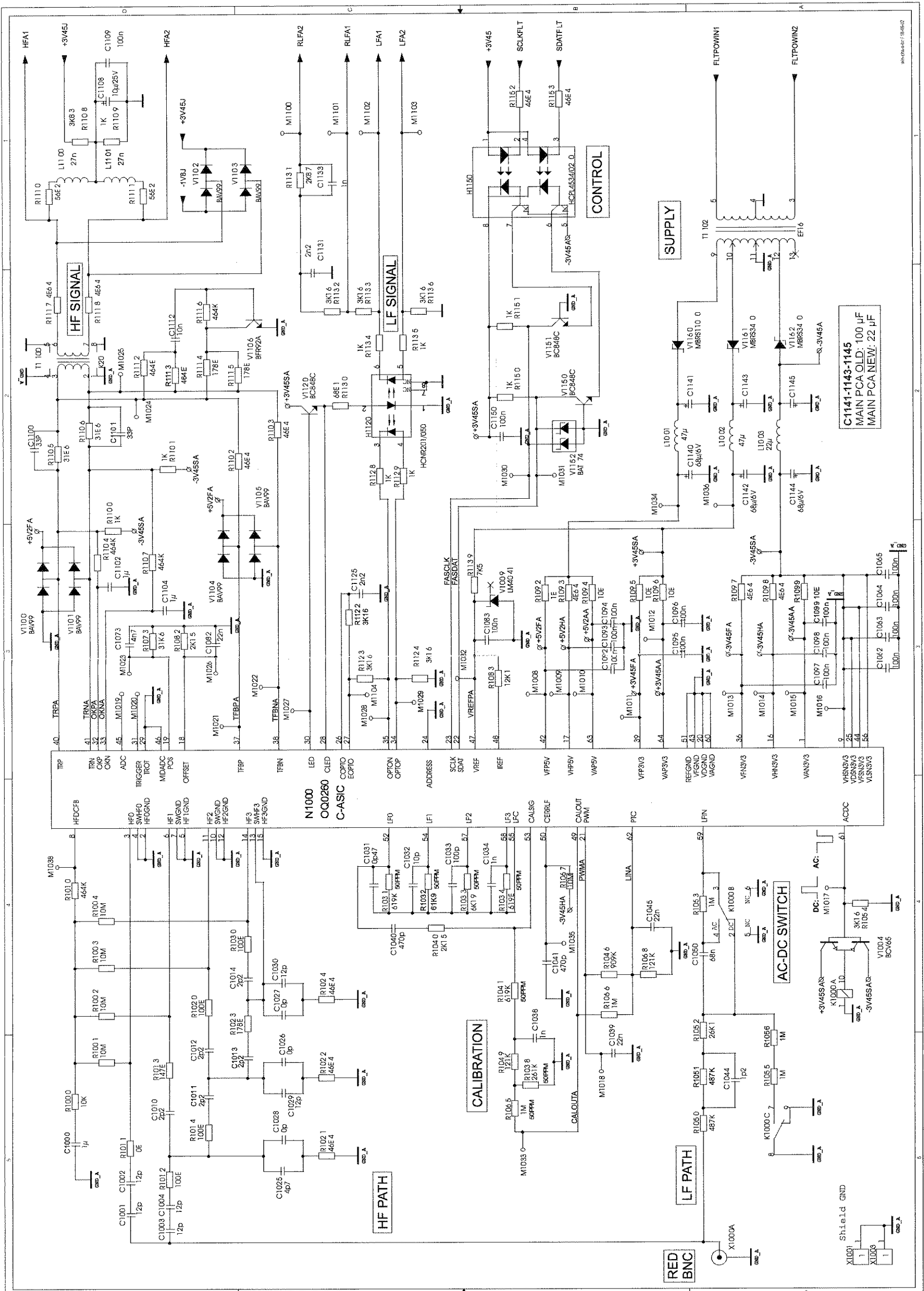

Figure 9-1. Scope Channel A

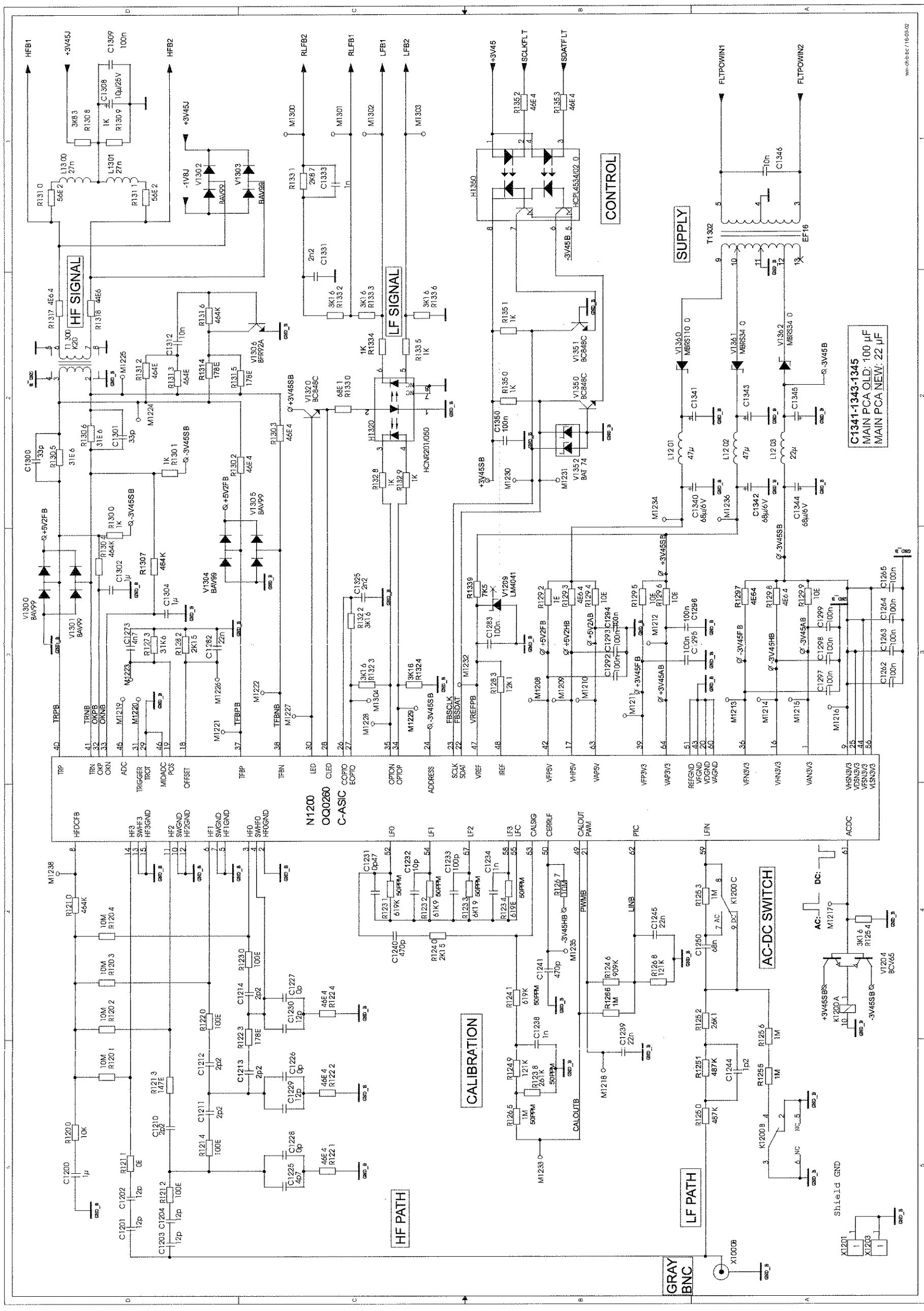
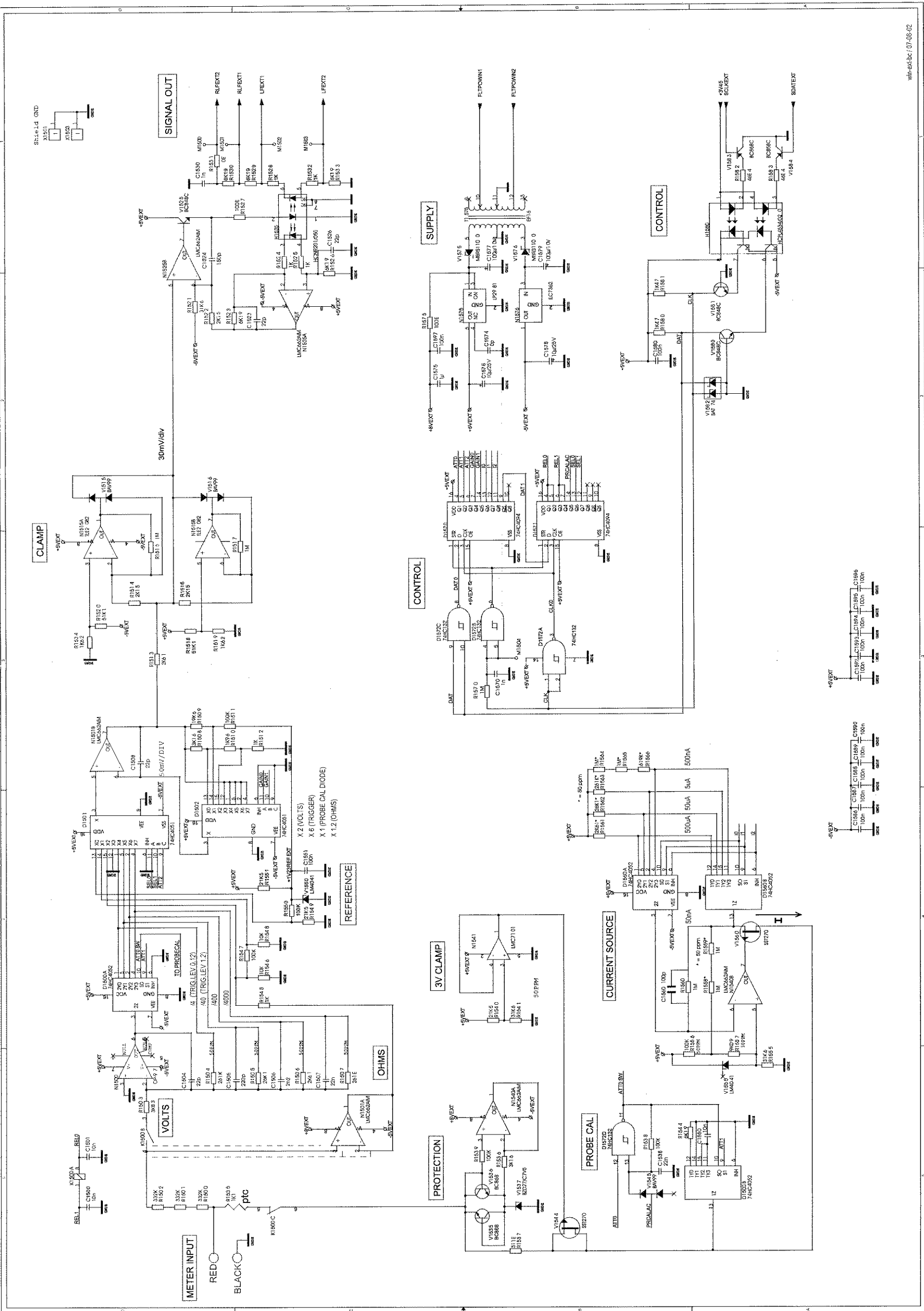

Figure 9-2. Scope Channel B

win-dfb-bc.wmf



win-ext-bc.wmf

Figure 9-3. Meter/External Trigger Channel

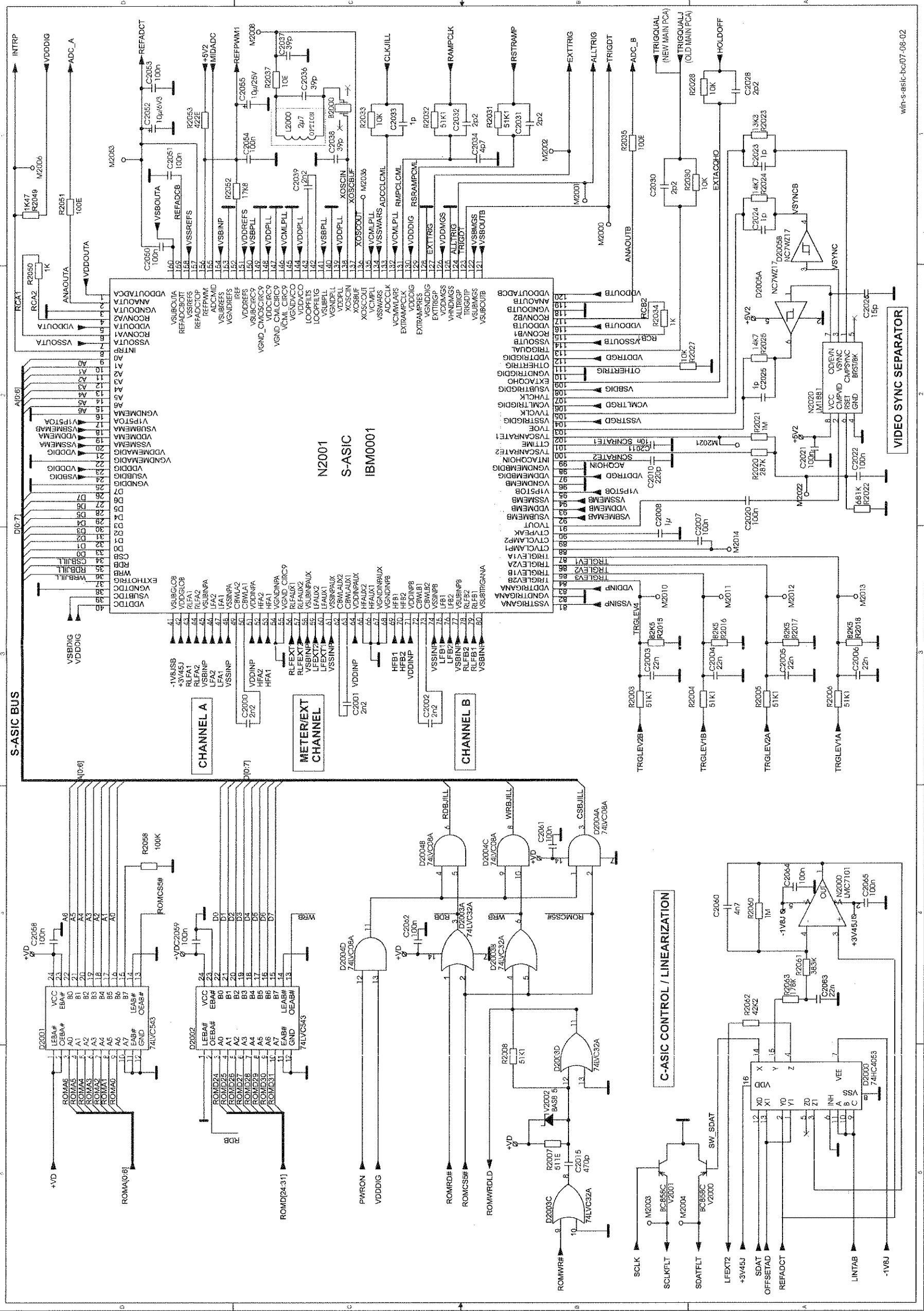
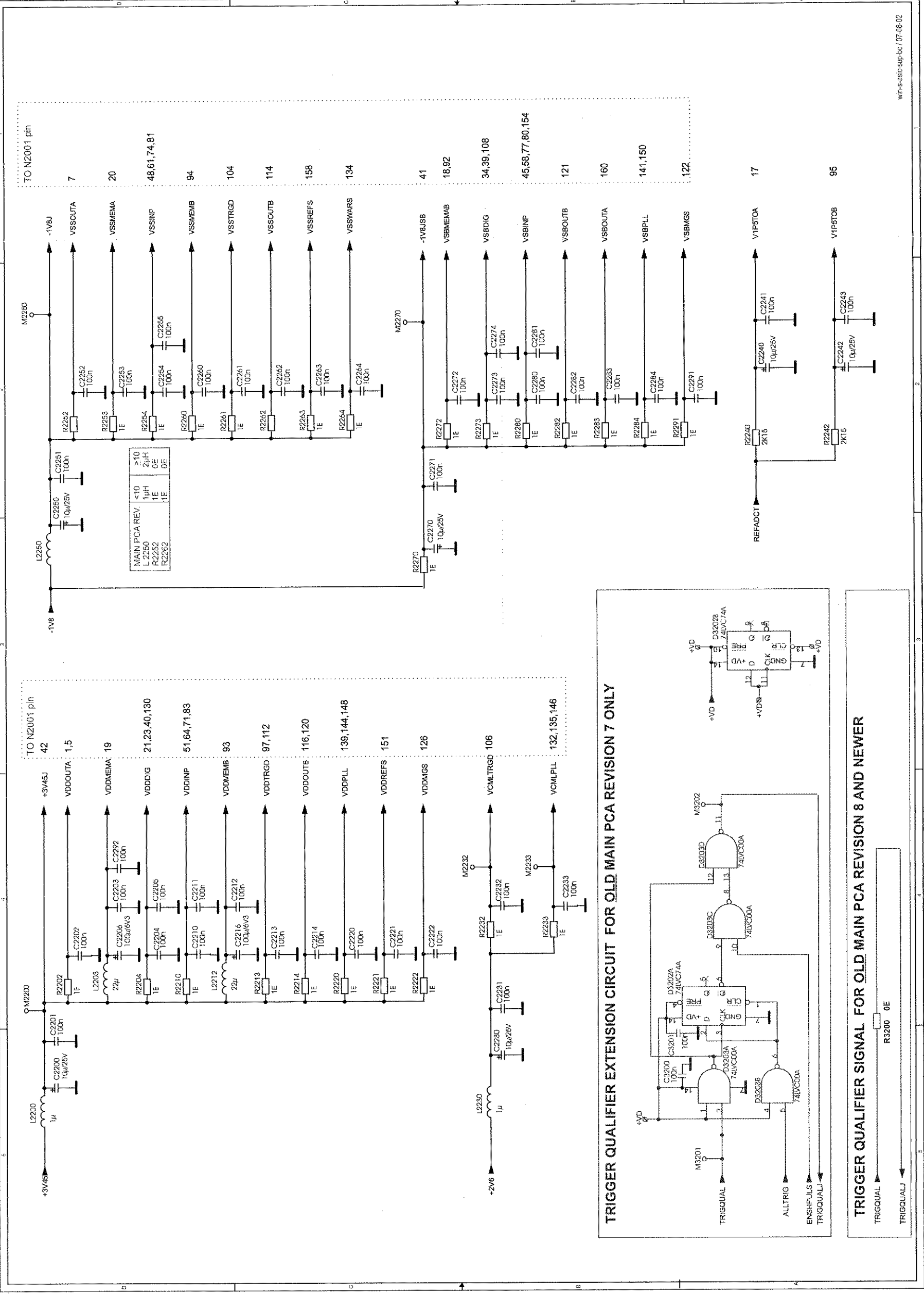

Figure 9-4. Sample & Trigger Circuit



wln-s-asic-sup-bc / 07-08-02

Figure 9-5. S-ASIC Supply

ADCs FOR OLD MAIN PCA

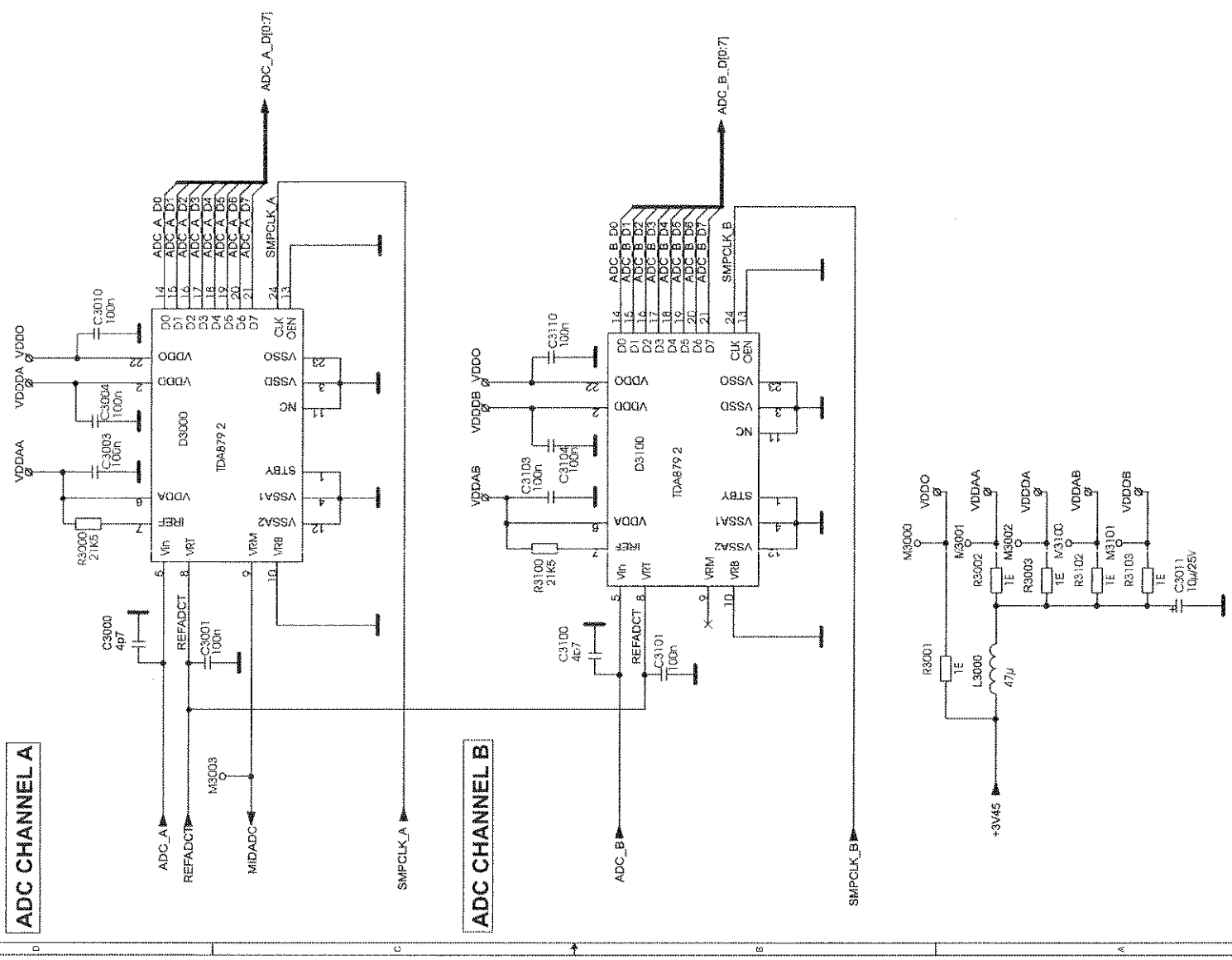

ADCs FOR NEW MAIN PCA

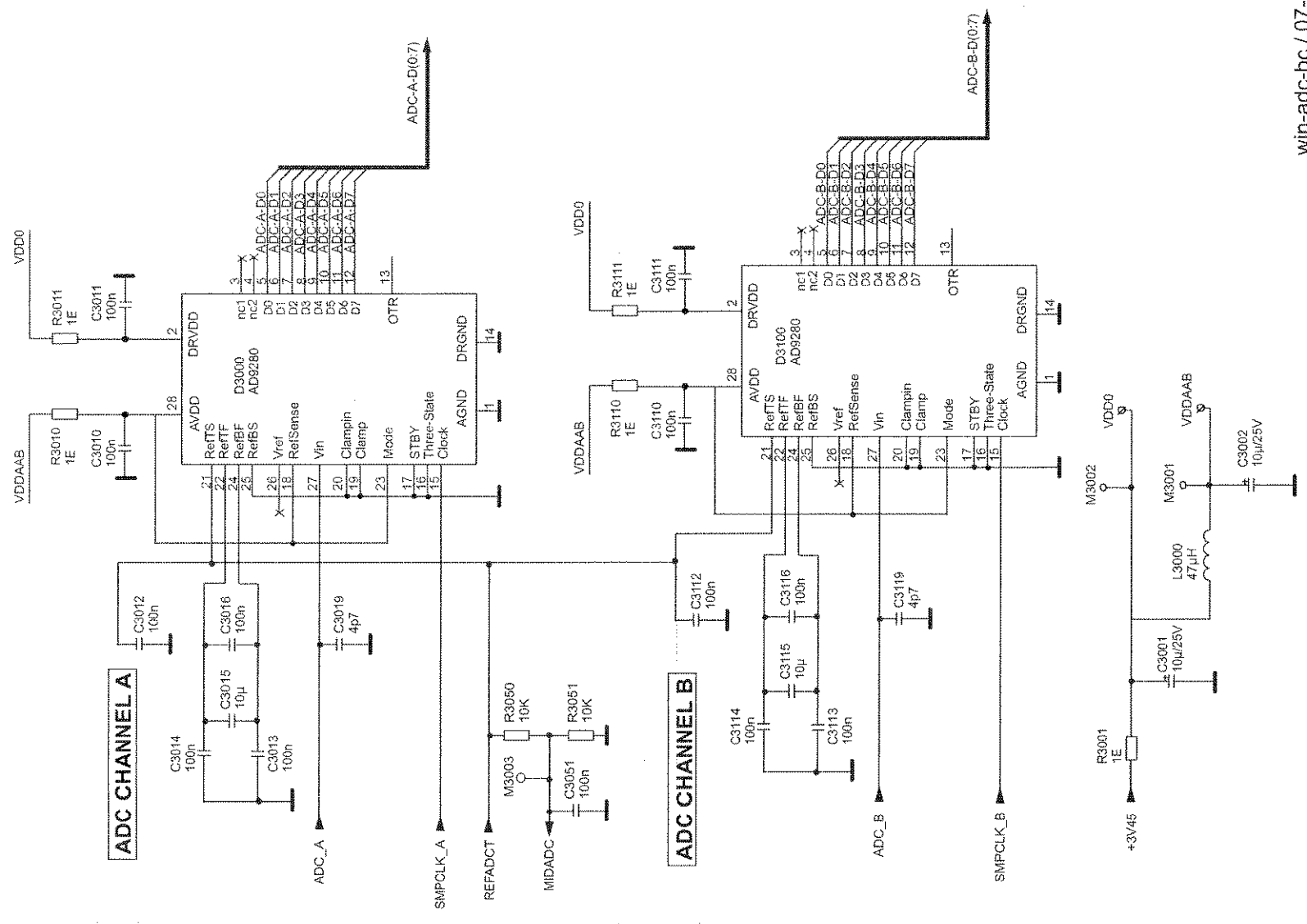

Figure 9-6. ADC's, Trigger Qualifier Extender

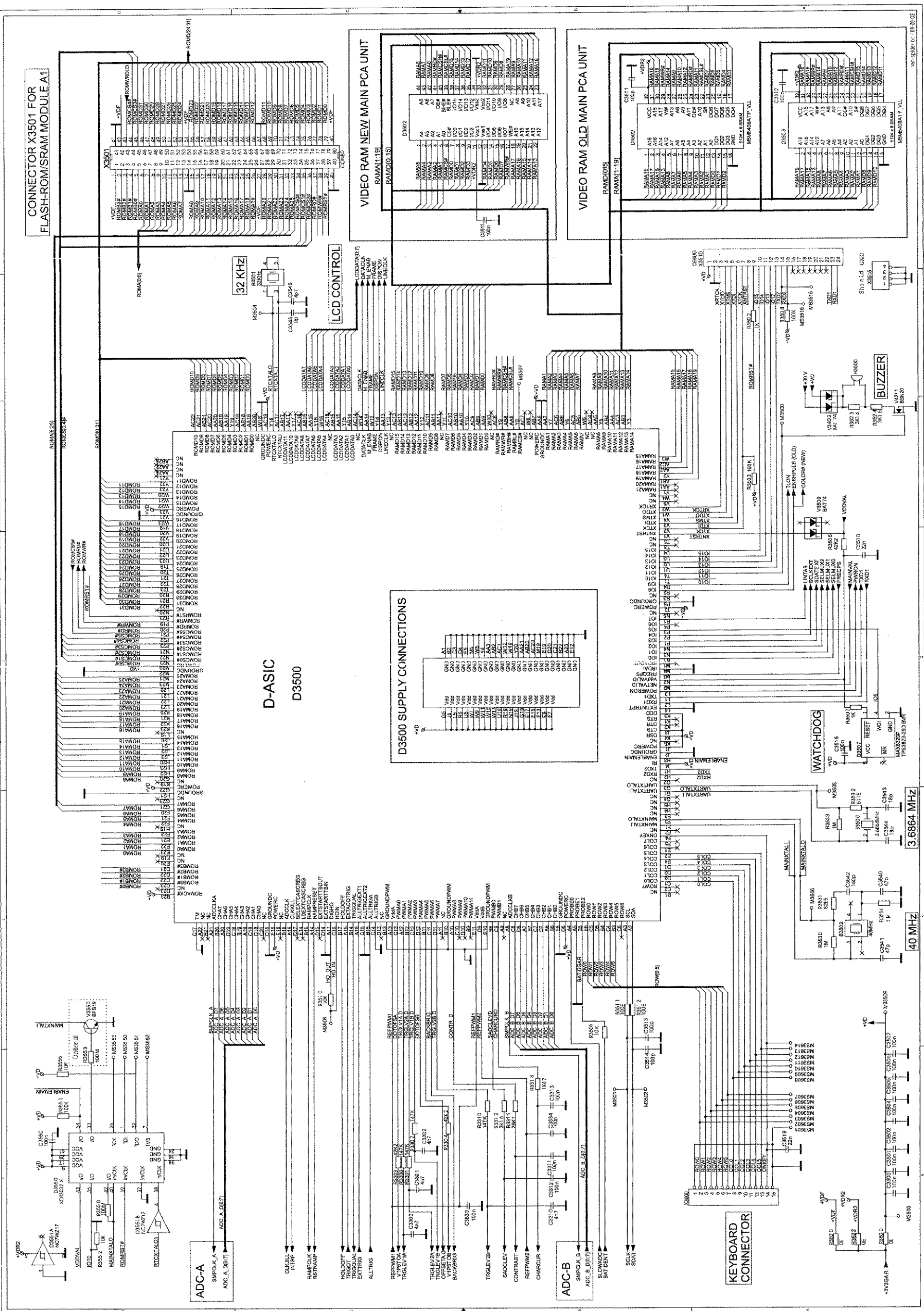

Figure 9-7. Digital Control

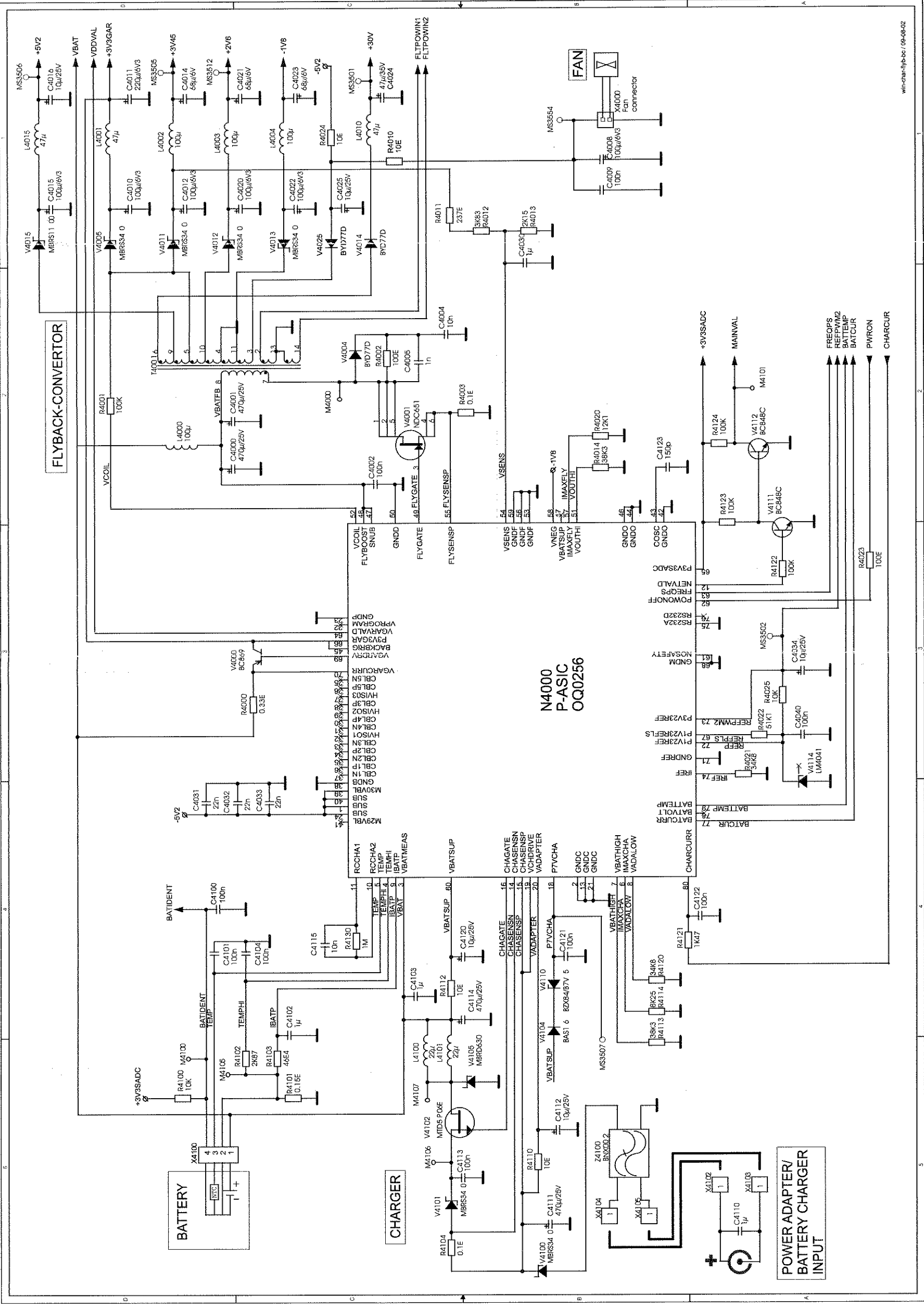
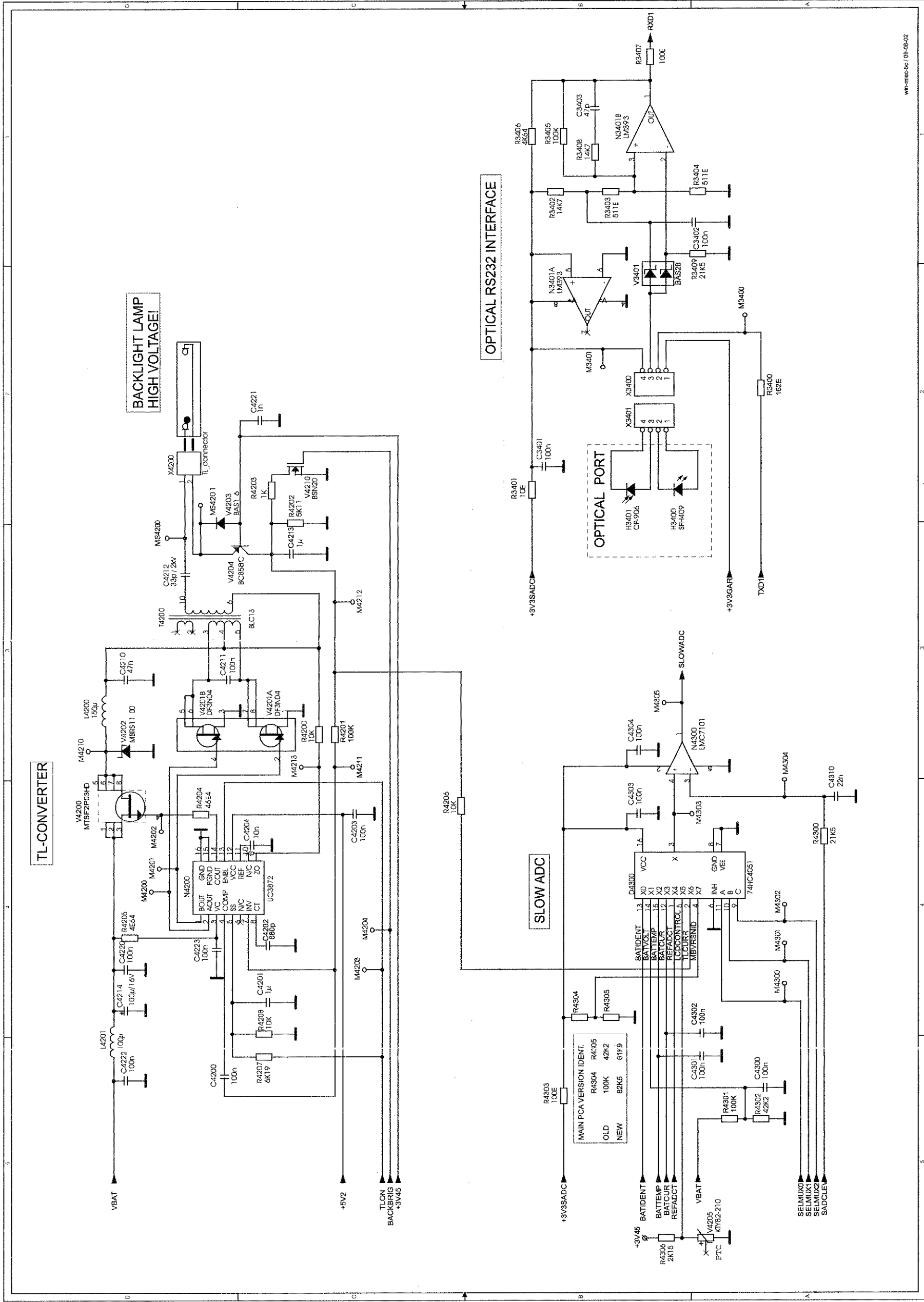

Figure 9-9. Power Circuit



wh-misc-bc/09-08-02

Figure 9-10. Backlight, Slow ADC, Serial Interface

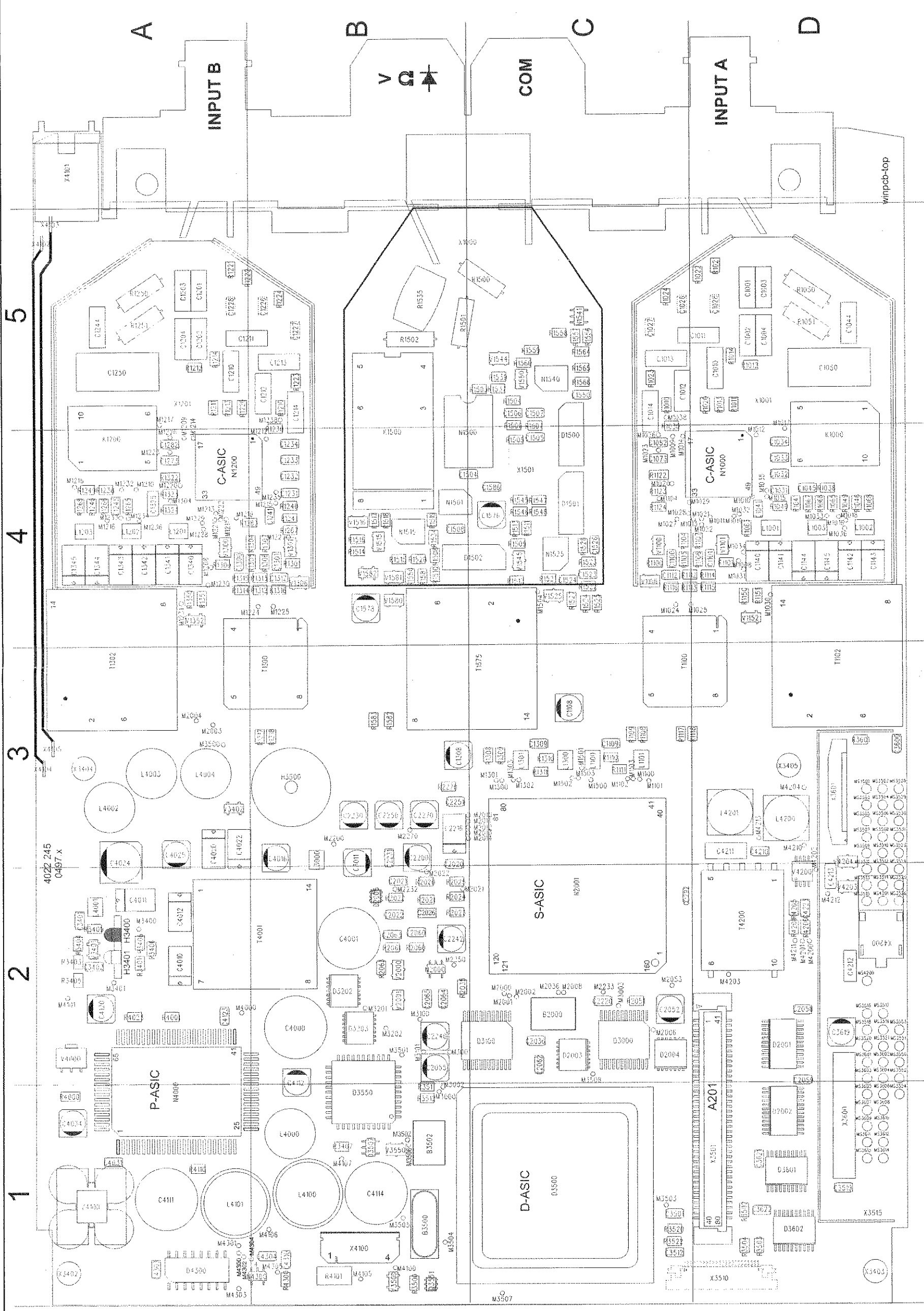

Figure 9-11. OLD Main PCA Top View

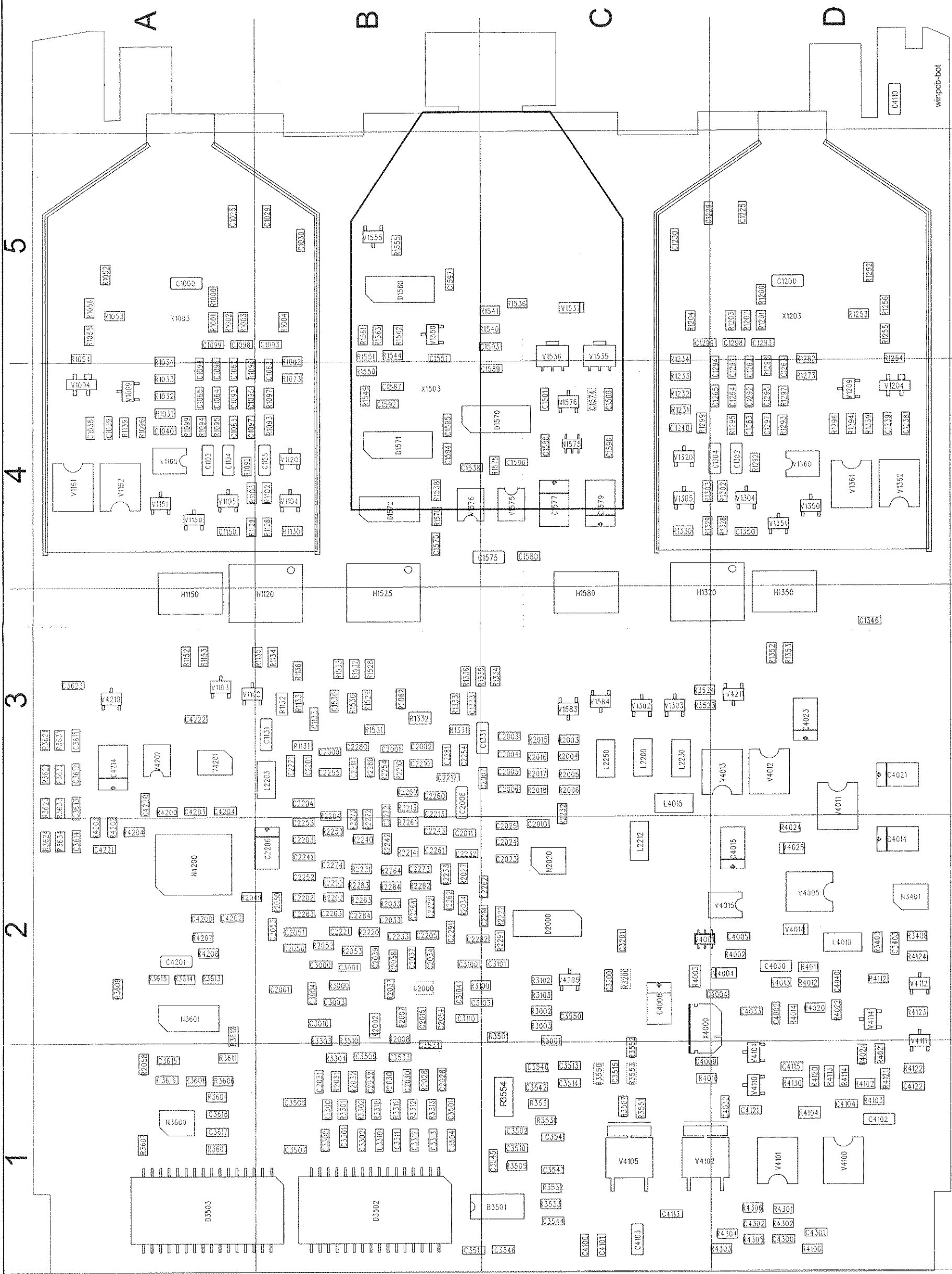
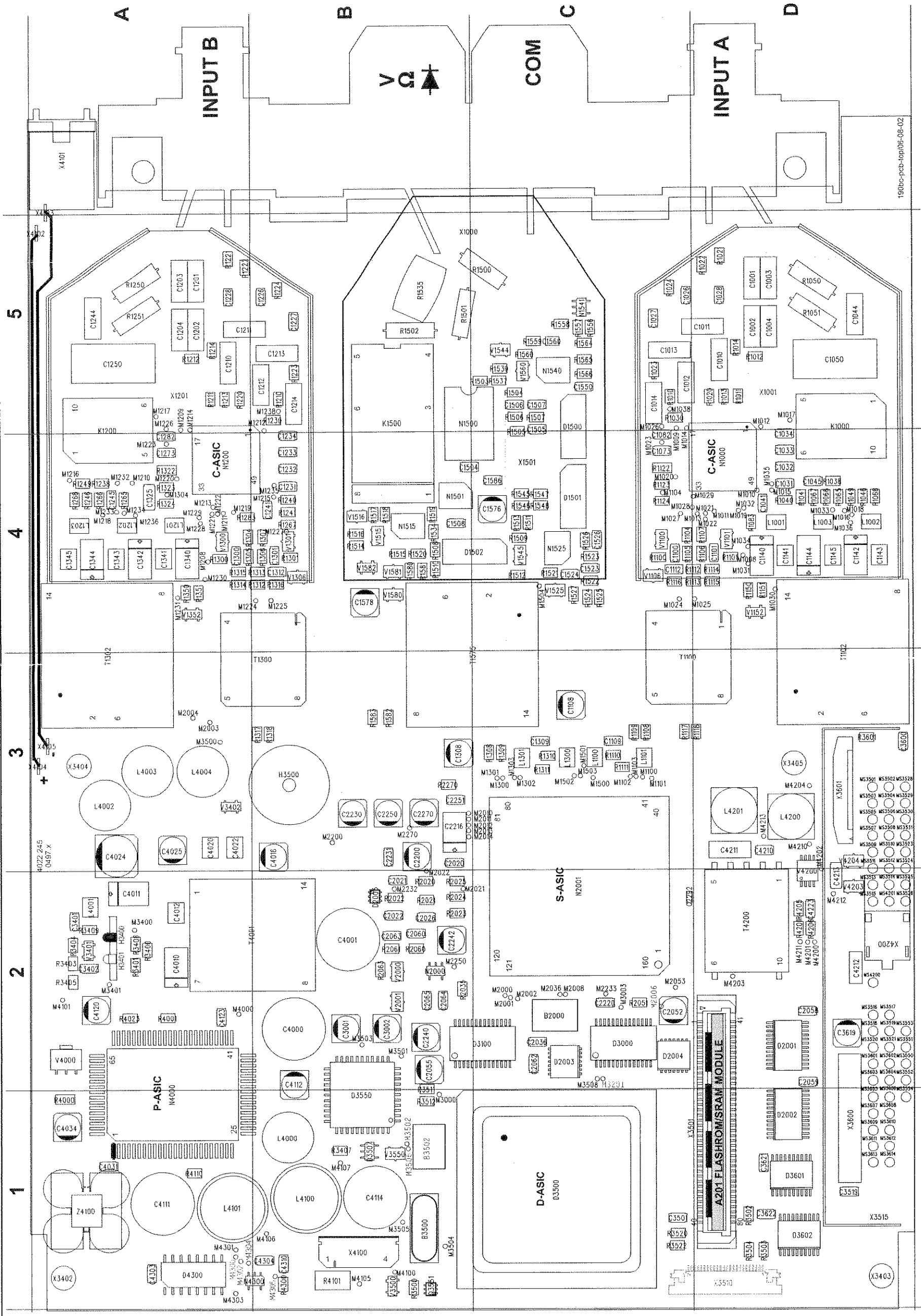

Figure 9-12. OLD Main PCA Bottom View



190bc-pcb-top.wmf

Figure 9-13. NEW Main PCA Top View

Chapter 10 Modifications

Title	Page
10.1 General.....	10-3
10.2 Software modifications.....	10-3
10.3 Hardware modifications.....	10-3
10.4 Main PCA Unit Versions, Software Versions.....	10-4

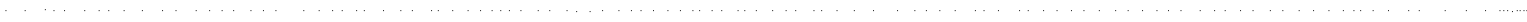



10.1 General

Changes and improvements made to the test tool are documented in Product Change Notices (PCN), and on supplemental change/errata sheets (MSU) .

10.2 Software modifications

Changes and improvements made to the test tool software are identified by incrementing the software version number.

To see the test tool software version number press  , then press  to open the VERSION & CAL... menu.

10.3 Hardware modifications

PCA (Printed Circuit Assembly)

Changes and improvements made to the test tool PCA (Printed Circuit Assembly) hardware are identified by incrementing its revision number (the revision numbers need not necessarily to be increased by 1). This number is printed on a sticker located on the Main PCA unit shielding box. Figure 10-1 shows the sticker for revision number 07.

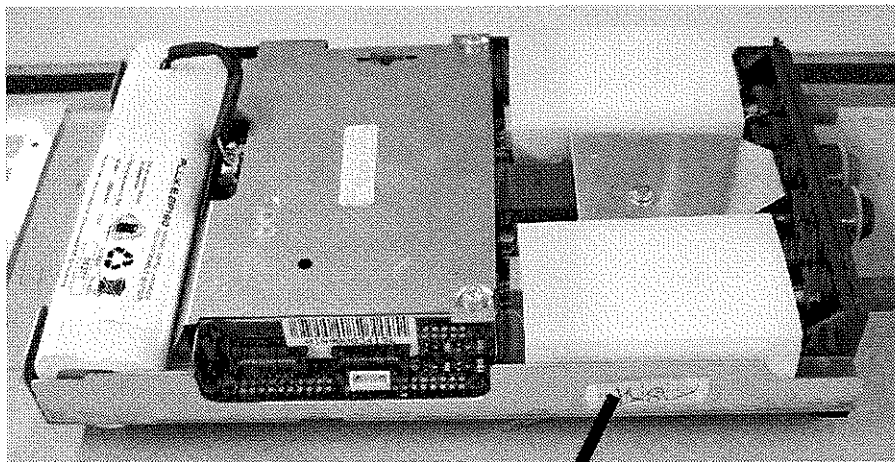

status sticker.jpg

07		

Figure 10-1. PCA revision number sticker

PCB (Printed Circuit Board)

The PCB (Printed Circuit Board without parts) version can be identified by checking its 12 digit code. This code is located on the board edge near the optical gate diodes H3400-H3401.

The code is 4022 245 0497x ; x is the version number of the PCB.

10.4 Main PCA Unit Versions, Software Versions.

All models Fluke 192B, 196B and 199B are shipped with a revised version Main PCA unit, referred to as NEW Main PCA unit. From November 2002 onwards, also the Fluke 196C and 199C can have the NEW Main PCA unit. The Main PCA unit used in the Fluke 196C and 199C before December 2002 will be referred to as OLD Main PCA unit.

To see if a Main PCA is a NEW or an OLD version check the PCB version (see 10.3):

- The NEW Main PCA unit has PCB version 6 or higher.
- The OLD Main PCA unit has a PCB version below 6.

The NEW Main PCA unit must have software version V05.04 or higher.

The NEW Main PCA unit can be used as replacement for the OLD Main PCA unit.

Software versions V05.04 and newer can also be loaded in the OLD Main PCA unit.